

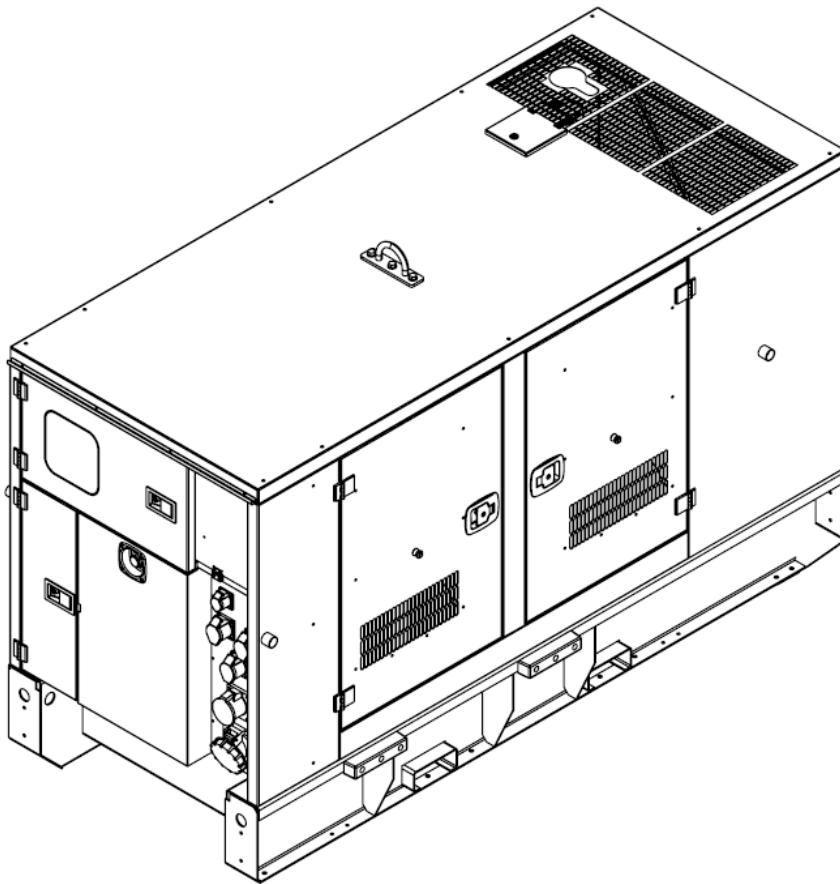

SSDP120 Handbook Deep Sea Electronics 7310



**DO NOT OPERATE THE GENERATOR BEFORE READING THIS MANUAL AND ENGINE
MANUFACTURER'S OWNER'S MANUAL AND WARNINGS.**

**THIS STEPHILL GENERATOR HAS BEEN DESIGNED TO PROVIDE SAFE AND EFFICIENT SERVICE IF
OPERATED AND MAINTAINED CORRECTLY.**

**MANY ACCIDENTS OCCUR THROUGH FAILURE TO ADHERE TO FUNDAMENTAL SAFETY
PROCEDURES.**

Stephill Generators Ltd
Wallis close
Park Farm South
Wellingborough
Northants
NN8 6AG

Tel : +44 (0)1933 677911
Fax : +44 (0)1933 677916
E-mail : info@stephill-generators.co.uk
Web : www.stephill-generators.co.uk

| Section | CONTENTS | Page |
|---------|--|-------|
| 1.0 | SPECIFICATION | 1 |
| 2.0 | GENERAL SAFETY | 1 |
| 2.1 | Warning signs | 1 |
| 2.2 | Safety hazards | 1 |
| 3.0 | POTENTIAL HAZARDS | 1 |
| 3.1 | Auxiliary power | 1 |
| 3.2 | Operating environment | 1 |
| 3.3 | Temperature range | 1 |
| 3.4 | Reference relative humidity | 2 |
| 3.5 | Reference barometric pressure | 2 |
| 3.6 | Flammable environment | 2 |
| 3.7 | Saline environment | 2 |
| 4.0 | SAFETY CONSIDERATIONS | 2 |
| 4.1 | General | 2 |
| 4.2 | Fuel | 2 |
| 4.3 | Bunded tank | 2 |
| 4.4 | Lubricating oil | 2 |
| 4.5 | Safe lifting | 2 |
| 4.6 | Earth connection | 2 |
| 4.7 | Fumes | 2-3 |
| 4.8 | Noise | 3 |
| 4.9 | Battery acid | 3 |
| 4.10 | Fire | 3 |
| 4.11 | Hot parts | 3 |
| 5.0 | OPERATING INSTRUCTIONS | 3 |
| 5.1 | Pre-Start checks | 3 |
| 5.2 | Emergency stop | 3 |
| 5.3 | Three way valve | 3 |
| 5.4 | Fuel lift pump priming | 3 |
| 5.5 | Control panel | 3 |
| 5.6 | Variable RCD ELR-3C | 4 |
| 5.7 | Hard wire terminals | 4 |
| 5.8 | Remote start terminals | 4 |
| 5.9 | Long term storage | 4 |
| 6.0 | DEEP SEA 7310 OPERATING INSTRUCTIONS | 5 |
| 6.1 | Controls | 5-6 |
| 6.2 | Manual mode | 6 |
| 6.2.1 | Waiting in manual mode | 6 |
| 6.2.2 | Starting sequence | 6 |
| 6.2.3 | Stopping sequence | 7 |
| 6.3 | Automatic mode | 7 |
| 6.3.1 | Waiting in auto mode | 7 |
| 6.3.2 | Starting sequence | 7 |
| 6.3.3 | Stopping sequence | 7 |
| 6.4 | Stop mode | 7 |
| 6.5 | Viewing the instrument pages | 8 |
| 6.5.1 | Status | 8 |
| 6.5.2 | Engine | 9 |
| 6.5.3 | Generator | 9 |
| 6.5.4 | CAN error messages | 9 |
| 6.5.5 | Viewing the event log | 9-10 |
| 6.6 | ECU override | 10-11 |
| 6.7 | Engine | 11 |
| 6.8 | Generator | 11 |
| 7.0 | Protections | 11 |
| 7.1 | Alarms | 11-12 |
| 7.1.1 | Shutdown / electrical trip alarms | 12 |
| 7.1.2 | CAN alarms | 12 |
| 7.2 | Warnings | 12-13 |
| 7.2.1 | High current warning alarm | 13 |
| 7.2.2 | Shutdowns | 13-14 |
| 7.2.3 | IDMT alarm | 14-15 |
| 7.2.4 | Maintenance alarm | 15-16 |
| 8.0 | Fault finding 7310 | 16 |
| 9.0 | Fault finding general | 17 |
| 10.0 | Spares | 18 |
| 10.1 | Perkins consumable spares | 18 |
| 10.2 | General spares | 18-19 |
| 11.0 | Service and maintenance | 19 |
| 11.1 | Engine service | 19-20 |
| 11.2 | Light load operation | 20-21 |
| 11.3 | Alternator service | 21 |
| 12.0 | Warranty | 21 |
| | SSDP120 400V Wiring DSE 7310 | 22 |
| | Perkins 1100 Series Wiring ECU Deep Sea 7310 | 23 |
| | SSDP120 Exploded view | 24 |
| | SSDP120 Canopy parts list | 25 |

1 SPECIFICATION

| GENERATOR SPECIFICATION SSDP120 | | | | |
|--|------------------------------|------------------|--------|-----------|
| Frequency | 50Hz | | | |
| Phase | 3 | | | |
| Voltage | 400/230 | | | |
| Standby Power (ESP) | 117.1 kVA 93.7 kW | | | |
| Prime Power (PRP) | 106.1 kVA 84.9 kW | | | |
| Engine | Perkins 1104D-E44TAG2 Engine | | | |
| Emissions certified | EU (EU 97/68/EC Stage IIIa) | | | |
| Displacement | 4.4 Litres | | | |
| Aspiration | Turbo charged | | | |
| Alternator | 105kVA Meccalte ECP 34-2S/4 | | | |
| AVR | DER 3Ø Electronic +/- 1% | | | |
| Fuel tank capacity | 470 Litres | | | |
| Autonomy 100% load | 19 Hours | 24.5 Litres hour | | |
| Autonomy 75% load | 24 Hours | 19.8 Litres hour | | |
| Autonomy 50% load | 35 Hours | 13.2 Litres hour | | |
| LWA | 92 | | | |
| DBA @ 7M | 67 | | | |
| DBA @ 4M | 72 | | | |
| DBA @ 1M | 84 | | | |
| DIMENSIONS SSDP120 | | | | |
| | Length | Width | Height | Weight KG |
| SSDP120 Skid dry | 2710 | 1100 | 1650 | 1944 |
| SSDP120 Skid wet | 2710 | 1100 | 1650 | 2335 |
| SSDP120 Trailer dry | 4500 | 1700 | 1960 | 2156 |
| SSDP120 Trailer wet | 4500 | 1700 | 1960 | 2547 |

2 GENERAL SAFETY

2.1 Warning signs

Warnings shown on the machine should be observed at all times. The warning signs should be checked for legibility and any that have become damaged should be replaced.

2.2 Safety hazards

Do not climb on the generator, as dents may cause overheating of the acoustic lining.

It is important to keep the generator clean and well serviced, in particular keep all air vents / louvers clear of debris to prevent poor performance or possible overheating and permanent damage to the generator. Keep well clear of moving parts on the generator at all times.

3 POTENTIAL HAZARDS

3.1 Auxiliary power

The electricity produced by an engine driven Generator is very similar to mains electricity and should be treated accordingly.

Do not remove covers and attempt to work on the Generator while the engine is running.

Check the rating and electrical safety of the load before connecting the Generator.

Equipment should never be connected that in total exceeds the specified rating of the Generator.

Installation of the generator as a standby or secondary power source should only be undertaken by a fully qualified electrician using the appropriate means of isolation from the mains supply. Installation must comply with all applicable laws and electrical codes.

3.2 Operating Environment

The Generator should always be operated on level ground.

3.3 Temperature Range

A temperature range between -15°C and +50°C are the normal limits of operation. Operating outside the range will require additional modifications.

3.4 Reference Relative Humidity

The standard reference condition for relative humidity is 30%. Above this value the rated power must be reduced.

3.5 Reference Barometric Pressure

The standard reference condition for total barometric pressure is 1 bar.

This corresponds to an altitude of approximately 100m. Above 100m the rated power must be reduced.

3.6 Flammable Environment

Stephill Generators must not be used in a flammable environment.

3.7 Saline Environment

Operation of the machine in a saline environment will require additional corrosion protection.

4 SAFETY CONSIDERATIONS

4.1 General

All Stephill Generators comply with all the current EEC directives including:

2006/42/EC Machinery Directive

2000/14/EC Noise Emission in the Environment by Equipment for use Outdoors

2014/30/EU EMC Directive

2014/35/EU Low Voltage Directive

4.2 Fuel

Fuels and lubricants are a potential source of fire. Be careful not to spill fuel, clean up any spillages. Inhalation or swallowing of Diesel should be avoided. If in doubt seek medical advice. All other forms of contact are irritant and therefore should also be avoided. If skin contact is made wash with soap and water.

4.3 Bunded tank

This generator is fitted with a secondary containment system (Bunded tank). The bund will need to be inspected on a regular basis and drained accordingly. Any liquid drained from the Bund/Tank will have to be treated as Oil/Fuel contaminated waste and disposed of accordingly.

Warning

Although this generator is fitted with a Bunded tank it is the duty of the owner to ensure that it meets with Local/National regulations dependant on site location etc.

4.4 Lubricating Oil

New oil presents no hazard following short term exposure. Lubricants in particular used engine oil, are potentially carcinogenic. Direct contact should always be avoided by wearing suitable rubber gloves when handling them. Used oil should not be allowed to contact the skin. If this does occur, wash off quickly with a proprietary hand cleanser.

4.5 Safe Lifting

Where mechanical assistance is used in lifting machines, ensure the lifting eye is used, and that all components used to lift the machine are within their Safe Working Load (SWL).

The integral lifting beam and associated lifting eye on the generator should be regularly checked for signs of damage or gross corrosion.

All Nuts and Bolts associated with the lifting beam should be regularly checked for tightness and corrosion. Lifting equipment should not be attached directly to the Engine/Alternator except for lifting of Engine/Alternator only.

4.6 Earth connection

All Stephill products are fitted with an earth stud on the control panel this must be connected to an earthing system or spike. Any earth spike required is dependant on the local conditions of use. The size is determined by reference to current IEE regulations or to a competent electrician.

4.7 Fumes

Make sure that the Generator is at least 2 metres away from any building during operation. Operate in a well ventilated unconfined area, so that fumes can be properly dispersed. Silencer outlet should

be facing an open area to prevent fumes being recirculated. There is the danger of asphyxiation due to exhaust gases. Inhalation of poisonous exhaust fumes can lead to serious injury or death. The generator must not be used in a poorly ventilated or enclosed area.

4.8 Noise

Ear protection may be required depending on the combined noise level of the Generator, auxiliary load and the operator's distance from it and the length of exposure. (Noise at Work Regulations 1989)

4.9 Battery Acid

This is corrosive and irritant by all forms of exposure. If skin contact is made wash with clean water.

4.10 Fire

Ensure that suitable fire extinguishers (AFFF or CO₂) are kept within close proximity of the generator. Do not cover, enclose, or obstruct the airflow to the generator during or shortly after use, due to fire hazard or damage to the generator from overheating. Allow the generator to cool after use before storing away. Keep all inflammable objects clear of the Generator.

4.11 Hot parts

There is the danger of burns as parts of the generator will become very hot during use. No part of the engine, alternator or exhaust must be touched during or shortly after operation. Do not operate the generator unless all guards are in place. There is a risk of burns or serious mechanical injury.

5 OPERATING INSTRUCTIONS

5.1 Pre-start checks

- Before starting the generator please read the engine owner's manual.
- Check **Fuel, Water & Oil** level before attempting to start.
- The engine is equipped with an oil pressure and temperature switch and will shut-down for low oil pressure and high engine temperature.
- Inspect the generator visually for signs of fault or damage.
- Ensure battery isolator switch is switched on.

5.2 Emergency stop

The generator is equipped with an emergency stop button which should only be used in an emergency and not for general stopping.

5.3 Three Way valve

This unit is equipped with a 3 Way valve (1/2" BSP fittings) which needs to be set to the correct position for the Generator to operate 'an instruction label is located next to the 3 way valve. The Engine is fitted with a lift pump for fuel delivery but this is not capable of lifting fuel above a certain height, it is therefore advisable to have the remote fuel tank at a higher level than the generator fuel tank to allow gravity feed to the lift pump. If this is not possible a remote fuel pump with a bypass valve fitted will suffice. If in any doubt please consult manufacturer.

5.4 Fuel lift pump priming

If engine runs out of fuel do not attempt to start until fuel bowl is full of diesel, this can be achieved by pumping plunger on fuel filter until bowl is full of diesel, the engine should then self-bleed and start.

5.5 Control panel

This generator is equipped with an RCD.

Before connecting plugs into generator please ensure the load is turned off.

If this is not possible turn the circuit breaker to the off position.

Connect the plugs into the generator.

Switch on the load / Circuit breaker.

This unit is also fitted with individual Circuit Breakers on each socket.

Warning

Always switch load off before disconnecting plugs.

To switch power off at Generator always use MCCB.

5.6 Variable RCD ELR-3C

The RCD and Bypass switch should only be adjusted or switched by an electrician with the appropriate test equipment.

ELR-3C Earth Leakage Relay Description

Its wide setting ranges allows user to select the tripping current, in order that the contact voltage values are maintained below 50V as required by the CEI 64-8Standard.

This is also the suitable answer for a proper selectivity, whenever there are other ELR's or/and RCD's downstream or upstream in the line to be protected.

An outstanding characteristic of the present relays, is the permanent control of the Toroidal - ELR circuit.

Its interruption brings along the immediate trip of the protection. This allows to identify the anomaly, without waiting to the periodical control, made with the Test push button.

The instrument, fitted with filters at the input circuits, is practically immune to external disturbances, so as the pulse currents with dc components, complying with the requirements of VDE 0664 and project IEC 23 Standards.

The ELR-3C has the possibility of an automatic or manual reset, selectable by a micro switch and to protect the settings by its sealable transparent front cover.

- 1) Current tripping setting potentiometer.
- 2) Tripping time setting potentiometer.
- 3) Micro switches for programming:
 - a In position 1 automatic reset, In position 0 manual reset.
 - b Selection of the multiplying constant.
- Tripping time, in position 1 K=10 in position 0 K=1
- c,d Selection of the multiplying constant of tripping current:
 - With c d in position 0 K=0.1
 - With c in position 1, d in position 0 K=1
 - With c,d in position 1 K=10
- 4) Push button for Test.
- 5) Push button for manual reset.
- 6) Signalling green LED for Aux. Supply presence.
- 7) Signalling red LED for relay tripped.
- 8) Terminals for Aux. Supply.

- 9) Output terminals for end relays
- 10) Connection terminals to T/T CT-1

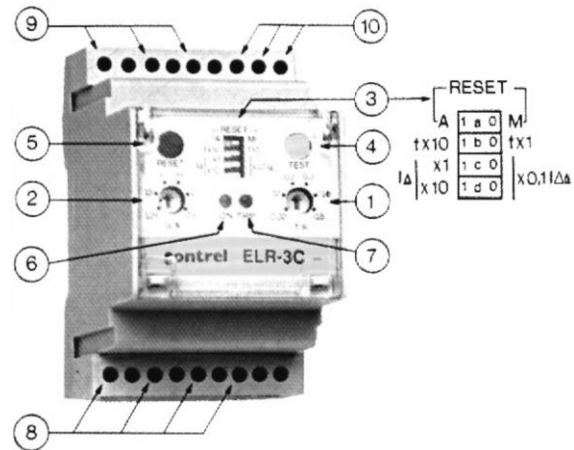

5.7 Hard wire terminals

Do not attempt to work on the hard wire terminals while the set is running, hard wire door is fitted with a magnetic switch to shut down generator if door is opened.

The generator is fitted with hard wire terminals which are located under the Circuit breakers, the terminals are clearly marked for 400Volt. They can be accessed by either drilling the steel gland plate or passing the cables through the rubber gland plate. If cables are passed through the rubber gland plate they must be secured with the cable clamp to prevent strain on terminals. The gland plate should be re-fitted prior to running generator.

5.8 Remote start terminals

The generator is equipped with a pair of normally open contacts which will start the generator when closed.

5.9 Long term storage

For storage or long periods of inactivity, Stephill Generators recommend the following:

Generators should be stored with oil filled to the correct capacity; Storage periods of 18 months and over may require special lubricants and treatments. If so please seek further advice from the engine manufacturer.

Before the generator is used after long term storage, all fuels and oils should be replaced.

Generator mounts, pipes and hoses should be checked to ensure that they are un-perished following extended periods of storage.





The generator should be stored in a clean dry area, ideally having a reasonable constant ambient temperature, and ideally not below freezing. The battery isolator switch should be switched off.

6 DEEP SEA 7310 Operating instructions

6.1 Controls



CAUTION: The module may instruct an engine start event due to external influences. Therefore, it is possible for the engine to start at any time without warning. Prior to performing any maintenance on the system, it is recommended that steps are taken to remove the battery and isolate supplies.

Control of the module is via push buttons mounted on the front of the module with *Stop/Reset Mode* , *Manual Mode* , *Auto Mode*  and *Start*  functions. For normal operation, these are the only controls which need to be operated. Details of their operation are provided later in this document.

DSE 7310

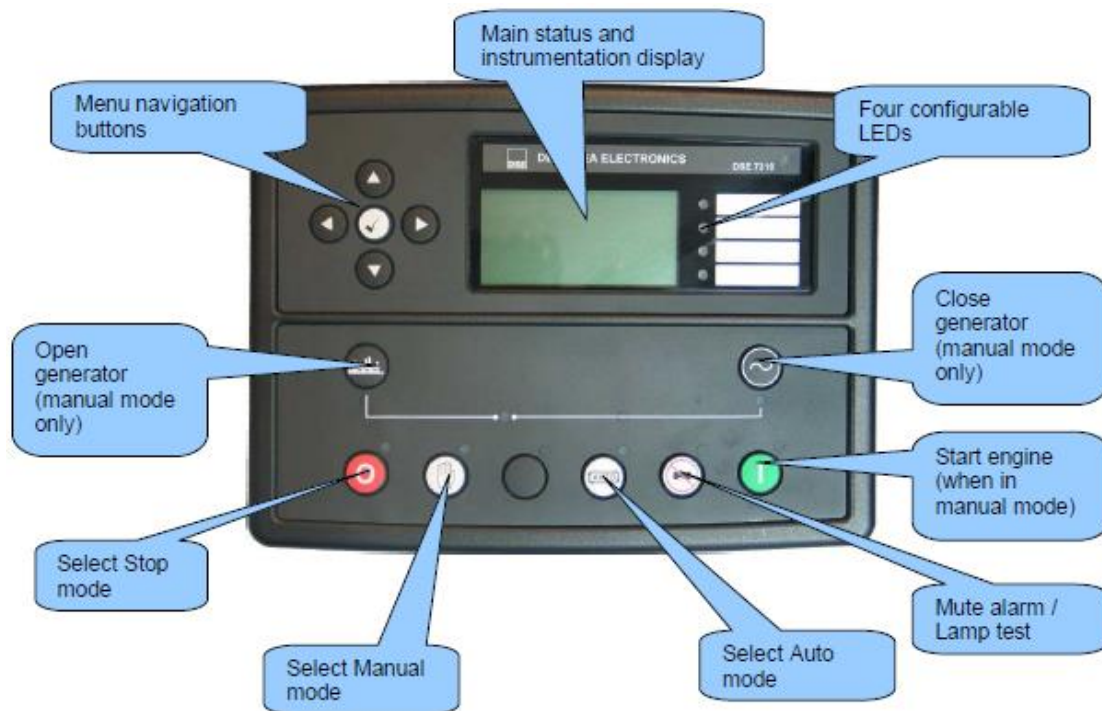

Control push buttons

Stop / Reset







This button places the module into its Stop/Reset mode. This will clear any alarm conditions for which the triggering criteria have been removed. If the engine is running and the module is in Stop mode, the module will automatically instruct the changeover device to unload the generator. The fuel supply de-energises and the engine comes to a standstill. Should a **remote start signal** be present while operating in this mode, a remote start will not occur.



Manual

This mode allows manual control of the generator functions. Once in Manual mode the module will respond to the start  button, start the engine, and run off load. If the engine is running off-load in the Manual mode and a remote start signal becomes present, the module will automatically instruct the changeover device to place the generator on load ('Close Generator' becomes active (if used)). Upon removal of the remote start signal, the generator remains on load until either selection of the 'STOP/RESET' or 'AUTO' modes. For further details, please see the more detailed description of 'Manual operation' elsewhere in this manual.



| | |
|---|---|
| <p>Auto This button places the module into its 'Automatic' mode. This mode allows the module to control the function of the generator automatically. The module will monitor the remote start input and mains supply status and once a start request is made, the set will be automatically started and placed on load. Upon removal of the starting signal, the module will automatically transfer the load from the generator and shut the set down observing the stop delay timer and cooling timer as necessary. The module will then await the next start event. For further details, please see the more detailed description of 'Auto operation' elsewhere in this manual.</p> |  |
| <p>START This button is only active in STOP/RESET  or MANUAL  mode. Pressing this button in manual or test mode will start the engine and run off load (manual) or on load (test). Pressing this button in STOP/RESET mode will turn on the CAN engine ECU (when correctly configured and fitted to a compatible engine ECU)</p> |  |
| <p>Mute / Lamp Test This button silences the audible alarm if it is sounding and illuminates all of the LEDs as a lamp test feature. When correctly configured and fitted to a compatible engine ECU, pressing this button in STOP/RESET mode after pressing the START  button (to power the ECU) will cancel any "passive" alarms on the engine ECU.</p> |  |
| <p>Menu navigation Used for navigating the instrumentation, event log and configuration screens. For further details, please see the more detailed description of these items elsewhere in this manual.</p> |  |

6.2 MANUAL MODE

Activate Manual mode by pressing  the pushbutton. An LED indicator beside the button confirms this action.

Manual mode allows the operator to start and stop the set manually, and if required change the state of the load switching devices.

Scheduled runs do not occur when the module is in *Manual Mode* waiting for a start request.

6.2.1 WAITING IN MANUAL MODE

When in manual mode, the set will not start automatically.

To begin the starting sequence, press the  button.

6.2.2 STARTING SEQUENCE

 **NOTE:- There is no start delay in this mode of operation.**

The engine will pre heat.

The fuel relay is energised and the engine is cranked.

 **NOTE:- The unit has been configured for CAN the ECU will receive the start command via CAN.**



If the engine fails to fire during this cranking attempt then the starter motor is disengaged for the *crank rest* duration after which the next start attempt is made. Should this sequence continue beyond the set number of attempts, the start sequence will be terminated and the display shows **Fail to Start**.

When the engine fires, the starter motor is disengaged.

After the starter motor has disengaged, the *Safety On* timer activates, allowing Oil Pressure, High Engine Temperature, Under-speed, Charge Fail and any delayed Auxiliary fault inputs to stabilise without triggering the fault.

6.2.3 STOPPING SEQUENCE

In *Manual Mode*  the set does not continue to run until either:

- The *Stop/Reset Mode*  button is pressed – The delayed load outputs are de-activated immediately and the set immediately stops.
- The *Auto Mode*  button is pressed. The set observes all *Auto Mode*  start requests and stopping timers before beginning the *Auto Mode Stopping Sequence*.

6.3 AUTOMATIC MODE

Auto Mode is activated by pressing the *Auto Mode*  button. An LED indicator beside the button confirms this action.

Auto Mode allows the generator to operate fully automatically, starting and stopping as required with no user intervention.

6.3.1 WAITING IN AUTO MODE

If a starting request is made, the starting sequence begins.

Starting requests can be from the following sources:

- Activation of an auxiliary input that has been configured to *Remote Start*.
- Activation of the inbuilt exercise scheduler.

6.3.2 STARTING SEQUENCE

To allow for 'false' start requests, the *start delay* timer begins.

Should all start requests be removed during the *start delay* timer, the unit returns to a stand-by state.

If a start request is still present at the end of the *start delay* timer, the fuel relay is energised and the engine is cranked.

If the engine fails to fire during this cranking attempt then the starter motor is disengaged for the *Crank Rest* duration after which the next start attempt is made. Should this sequence continue beyond the *Set Number Of Attempts*, the start sequence is terminated and the display shows *Fail to Start*.

The starter motor is disengaged when the engine fires. Speed detection is factory configured to be derived from the AC alternator output frequency, but can additionally be measured from a Magnetic Pickup mounted on the flywheel or from the CAN link to the engine ECU depending on module. Additionally, rising oil pressure can be used to disconnect the starter motor (but cannot detect underspeed or overspeed).

6.3.3 STOPPING SEQUENCE

After the starter motor has disengaged, the *Safety On Delay* timer activates, allowing Oil Pressure, High Engine Temperature, Under-speed, Charge Fail and any delayed Auxiliary fault inputs to stabilise without triggering the fault.

The *Return Delay* timer operates to ensure that the starting request has been permanently removed and isn't just a short term removal. Should another start request be made during the cooling down period, the set returns on load.

If there are no starting requests at the end of the *Return Delay* timer, the load is removed from the generator to the mains supply and the *cooling* timer is initiated.

The *Cooling Down* timer allows the set to run off load and cool sufficiently before being stopped. This is particularly important where turbo chargers are fitted to the engine.

After the *Cooling Down* timer has expired, the set is stopped.

6.4 STOP MODE

- Scheduled runs do not occur when the module is in *Stop/Reset Mode*  .

6.5 VIEWING THE INSTRUMENT PAGES

It is possible to scroll to display the different pages of information by repeatedly operating the next / previous page buttons.



If you want to view one of the instrument pages towards the end of the list, it may be quicker to scroll left through the pages rather than right!

Example



A Further press of the scroll right button, returns the display to the Status page. The complete order and contents of each information page are given in the following sections. Once selected the page will remain on the LCD display until the user selects a different page, or after an extended period of inactivity (LCD Page Timer), the module will revert to the status display. If no buttons are pressed upon entering an instrumentation page, the instruments will be displayed automatically subject to the setting of the LCD Scroll Timer. The LCD Page and LCD Scroll timers are configurable using the DSE Configuration Suite Software or by using the Front Panel Editor.

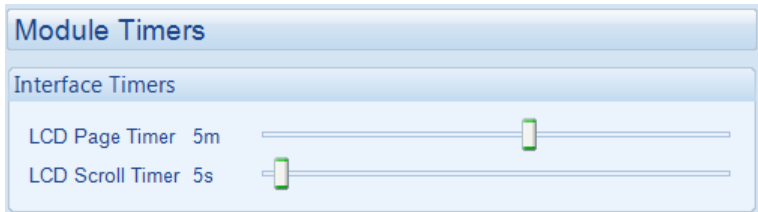

The screenshot shows the factory settings for the timers, taken from the DSE Configuration Suite Software.

Alternatively, to scroll manually through all instruments on the currently selected page, press the scroll buttons. The 'autoscroll' is disabled.

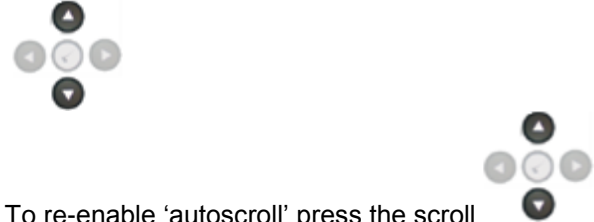

To re-enable 'autoscroll' press the scroll buttons to scroll to the 'title' of the instrumentation page (ie Engine). A short time later (the duration of the LCD Scroll Timer) the instrumentation display will begin to autoscroll. When scrolling manually, the display will automatically return to the Status page if no buttons are pressed for the duration of the configurable LCD Page Timer. If an alarm becomes active while viewing the status page, the display shows the Alarms page to draw the operator's attention to the alarm condition.

6.5.1 STATUS

This is the 'home' page, the page that is displayed when no other page has been selected, and the page that is automatically displayed after a period of inactivity (LCD Page Timer) of the module control buttons. This page is configurable using the DSE Configuration Suite Software.

| | | | |
|--------------------------|--------------|------------------------|-------------|
| Status | 22:31 | Safety On Delay | |
| Generator at Rest | | L-N | 215V 43A |
| Stop Mode | | L-L | 373V 47.5Hz |
| | | | 0KW 0.00pf |

Factory setting of Status screen showing engine stopped...and engine running.

6.5.2 ENGINE

Contains instrumentation gathered about the engine itself, some of which may be obtained using the CAN or other electronic engine link.

- Engine Speed
- Oil Pressure
- Coolant Temperature
- Engine Battery Volts
- Run Time
- Fuel Level
- Engine Maintenance Due 500 Hours
- Engine ECU Link

6.5.3 GENERATOR

Contains electrical values of the generator (alternator), measured or derived from the module's voltage and current inputs.

- Generator Voltage (ph-N)
- Generator Voltage (ph-ph)
- Generator Frequency
- Generator Current
- Generator Earth Current
- Generator Load (kW)
- Generator Load (kVA)
- Generator Power Factor
- Generator Load (kVAr)
- Generator Load (kWh, kVAh, kVArh)
- Generator Phase Sequence
- Dual Mutual Status

6.5.4 CAN ERROR MESSAGES

When connected to a suitable CAN engine the 7310 controller displays alarm status messages from the ECU.

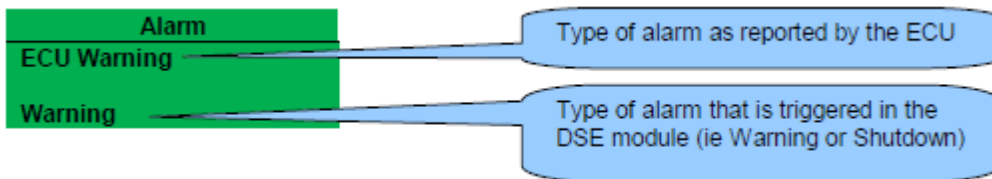

Press to access the list of current active Engine DTCs (Diagnostic Trouble Codes).

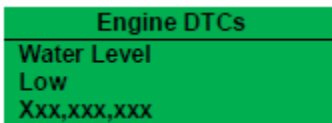

The code interpreted by the module shows on the display as a text message. Additionally, the manufacturer's code is shown.

NOTE:- For details on these code meanings, refer to the ECU instructions provided by the engine manufacturer, or contact the engine manufacturer for further assistance.

6.5.5 VIEWING THE EVENT LOG

The DSE7000 series modules maintain a log of past alarms and/or selected status changes.

The log size has been increased in the module over past module updates and is always subject to change. At the time of writing, the 7300 series log is capable of storing the last 250 log entries.

Under default factory settings, the event log only includes shutdown and electrical trip alarms logged (The event log does not contain Warning alarms),

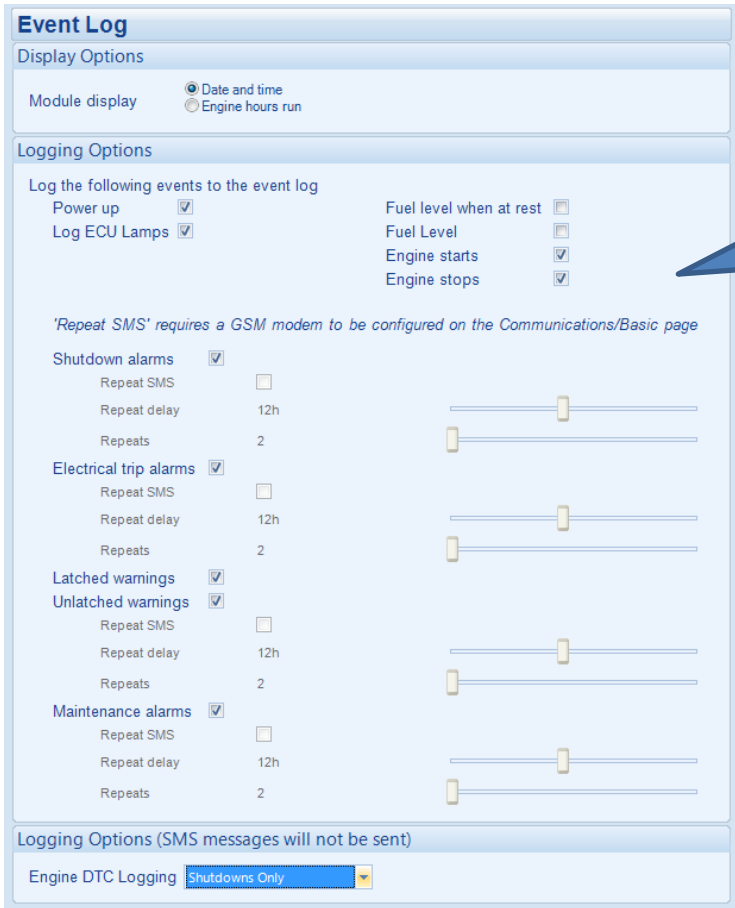



Example showing the configuration of the DSE7310 event log (DSE Configuration Suite Software) (Only shutdown alarms and the mains status are logged).

Once the log is full, any subsequent shutdown alarms will overwrite the oldest entry in the log. Hence, the log will always contain the most recent shutdown alarms. The module logs the alarm, along with the date and time of the event.

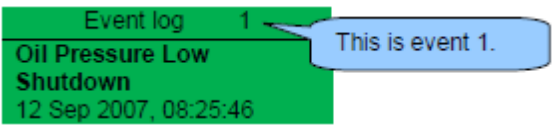
To view the event log, repeatedly press the next page button  until the LCD screen displays the Event log :





Press down  to view the next most recent shutdown alarm:

Continuing to press down  cycles through the past alarms after which the display shows the most recent alarm and the cycle begins again.

To exit the event log and return to viewing the instruments, press the next page  button to select the next instrumentation page.

6.6 ECU OVERRIDE

When the ECU is powered down when in STOP mode, it is not possible to read the diagnostic trouble codes or instrumentation. Additionally, it is not possible to use the engine manufacturers' configuration tools. As the ECU is usually unpowered when the engine is not running, it must be turned on manually as follows :

- Select STOP  mode on the DSE controller.
- Press and hold the START  button to power the ECU. As the controller is in STOP mode, the engine will not be started.
- The ECU will remain powered 2 minutes after the START button is released.

This is also useful if the engine manufacturer’s tools need to be connected to the engine, for instance to configure the engine as the ECU needs to be powered up to perform this operation.

6.7 ENGINE

These pages contain instrumentation gathered about the engine measured or derived from the module’s inputs.

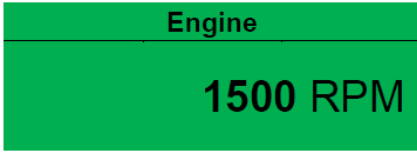

- Engine Speed
- Oil Pressure
- Coolant Temperature
- Engine Battery Volts
- Engine Run Time
- Fuel Consumption
- Fuel Used
- Fuel Level
- Flexible Sensors
- Engine Maintenance Alarm 1

6.8 GENERATOR

These pages contain electrical values of the generator, measured or derived from the module’s voltage inputs.

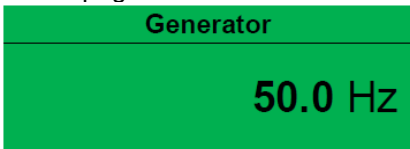

- Generator Voltage (ph-N)
- Generator Voltage (ph-ph)
- Generator Frequency
- Generator Current (A)
- Generator Load ph-N (kW)
- Generator Total Load (kW)
- Generator Load ph-N (kVA)
- Generator Total Load (kVA)
- Generator Power Factor Average
- Generator Load ph-N (kVAr)
- Generator Total Load (kVAr)
- Generator Accumulated Load (kWh, kVAh, kVArh)
- Generator Phase Sequence
- Active Configuration

7 PROTECTIONS

7.1 ALARMS

When an alarm is present, the Audible Alarm will sound and the Common alarm LED if configured will illuminate.

The audible alarm can be silenced by pressing the *Mute button* 

The LCD display will jump from the ‘Information page’ to display the Alarm Page

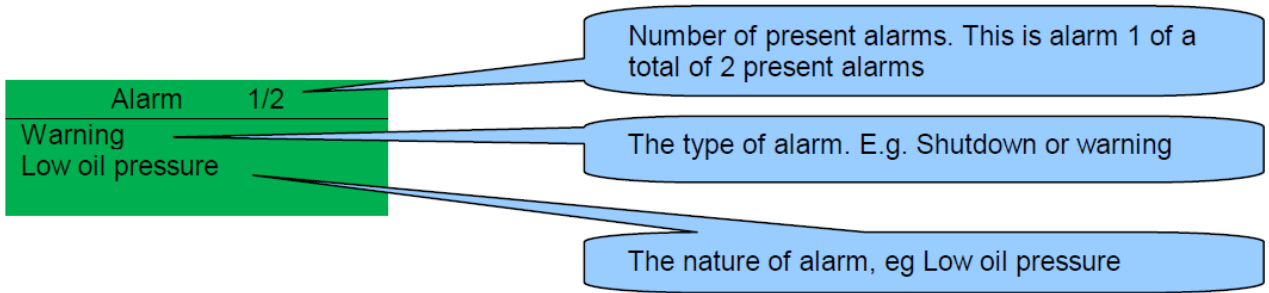

The LCD will display multiple alarms E.g. “High Engine Temperature shutdown”, “Emergency Stop” and “Low Coolant Warning”. These will automatically scroll in the order that they occurred.

In the event of a warning alarm, the LCD will display the appropriate text. If a shutdown then occurs, the module will again display the appropriate text.

Example:-

| | |
|-----------------------------|-----|
| Alarm | 1/2 |
| Warning Oil pressure Low | |

| | |
|--------------------------------------|-----|
| Alarm | 2/2 |
| Shutdown Coolant Temperature High | |

7.1.1 SHUTDOWN / ELECTRICAL TRIP ALARMS

 **NOTE:- The EMERGENCY STOP input and shutdown alarm continues to operate even when *Protections Disabled* has been activated.**

Under Shutdown or Electrical Trip alarm conditions (excluding Emergency Stop) :

- The alarm is displayed on the screen as detailed in the section entitled *Shutdown alarms* elsewhere in this document.
- The set continues to run.
- The load switch maintains its current position (it is not opened if already closed)
- **Shutdown Blocked** also appears on the LCD screen to inform the operator that the Protections Disabled feature has blocked the shutdown of the engine under the normally critical fault.
- The 'shutdown' alarm is logged by the controllers *Event Log* (if configured to log shutdown alarms) and also logs that the Shutdown was prevented.

7.1.2 CAN ALARMS

 **NOTE:- Please refer to the engine manufacturer's documentation for Can error message information.**

CAN alarms are messages sent from the CAN ECU to the DSE controller and displayed as follows in the below tables.

| Display | Reason |
|------------------------|--|
| CAN ECU WARNING | The engine ECU has detected a warning alarm and has informed the DSE module of this situation. The exact error is also indicated on the module's display and action taken depending upon the setting for the DM1 signals |
| ECU SHUTDOWN | The engine ECU has detected a shutdown alarm and has informed the DSE module of this situation. The exact error is also indicated on the module's display. |
| ECU DATA FAIL | The module is configured for CAN operation and does not detect data on the engine CAN datalink, the engine shuts down. |

DM1 Signals. Messages from the CAN ECU that are configurable within the DSE module for:-
Warning, Electrical Trip, shutdown or None

| Display | Reason |
|----------------------|---|
| Amber Warning | The CAN ECU has detected a Amber warning. |
| Red Shutdown | The CAN ECU has detected a Red Shutdown. |
| Malfunction | The CAN ECU has detected a Malfunction message. |
| Protect | The CAN ECU has detected a Protect message |

7.2 WARNINGS

Warnings are non-critical alarm conditions and do not affect the operation of the generator system, they serve to draw the operators attention to an undesirable condition.

Example

| | |
|---------------------------|-----|
| Alarm | 1/1 |
| Charge Failure Warning | |

In the event of an alarm the LCD will jump to the alarms page, and scroll through all active warnings and shutdowns.

By default, warning alarms are self-resetting when the fault condition is removed. However enabling 'all warnings are latched' will cause warning alarms to latch until reset manually. This is enabled using the 7000 series configuration suite in conjunction with a compatible PC.

7.2.1 HIGH CURRENT WARNING ALARM

GENERATOR HIGH CURRENT, if the module detects a generator output current in excess of the pre-set trip a warning alarm initiates. The module shows Alarm Warning High Current. If this high current condition continues for an excess period, then the alarm escalates to a shutdown condition. For further details of the high current alarm, please see High Current Shutdown Alarm.

High Current Warning Alarm is self-resetting when the overcurrent condition is removed.

7.2.2 SHUTDOWNS

Shutdowns are latching alarms and stop the Generator. Clear the alarm and remove the fault then press Stop/Reset



to reset the module.

Example

| | |
|---------------------------|-----|
| Alarm | 1/1 |
| Oil Pressure Low Shutdown | |



NOTE:- The alarm condition must be rectified before a reset will take place. If the alarm condition remains, it will not be possible to reset the unit (The exception to this is the Low Oil Pressure alarm and similar 'active from safety on' alarms, as the oil pressure will be low with the engine at rest).

| Display | Reason |
|--|---|
| FAIL TO START | The engine has not fired after the pre-set number of start attempts |
| EMERGENCY STOP | The emergency stop button has been depressed. This a failsafe (normally closed to battery positive) input and will immediately stop the set should the signal be removed. Removal of the battery positive supply from the emergency stop input will also remove DC supply from the Fuel and Start outputs of the controller. |
|  NOTE:- The Emergency Stop Positive signal must be present otherwise the unit will shutdown. | |
| FUEL USAGE | Indicates the amount of fuel measured by the fuel level sensor is in excess of the <i>Fuel Usage</i> alarm settings. This often indicates a fuel leak or potential fuel theft. |
| PHASE ROTATION | The phase rotation is measured as being different to the configured direction. |
| OVERSPEED | The engine speed has exceeded the pre-set trip |
| UNDERSPEED | The engine speed has fallen below the pre-set trip after the Safety On timer has expired. |
| GENERATOR OVER FREQUENCY | The generator output frequency has risen above the preset level |
| GENERATOR UNDER FREQUENCY | The generator output frequency has fallen below the preset level |
| GENERATOR OVER VOLTAGE | The generator output voltage has risen above the preset level |
| GENERATOR UNDER VOLTAGE | The generator output voltage has fallen below the preset level |
| OIL PRESSURE SENSOR OPEN CIRCUIT | The oil pressure sensor is detected as not being present (open circuit) |
| AUXILIARY INPUTS | An active auxiliary input configured as a shutdown will cause the engine to shut down. The display shows text of the fault. |

| Display | Reason |
|-------------------------------|--|
| ECU DATA FAIL | The module is configured for CAN operation and does not detect data on the engine Can datalink, the engine shuts down. |
| ECU SHUTDOWN | The engine ECU has detected a shutdown alarm and has informed the DSE module of this situation. The exact error is also indicated on the module's display. |
| KW OVERLOAD | The measured Total kW is above the setting of the kW overload shutdown alarm |
| NEGATIVE PHASE SEQUENCE | Indicates 'out of balance' current loading of the generator. Sometimes also called Negative Sequence Current or Symmetry Fault |
| MAINTENANCE DUE | Indicates that the maintenance alarm has triggered. A visit is required by the Generator service company. 500Hrs |
| GENERATOR HIGH CURRENT | A High Current condition has continued for an excess period, then the alarm escalates to either a shutdown or electrical trip condition (depending upon module configuration). For further details of the high current alarm, please see High Current Shutdown / Electrical Trip Alarm. |
| LOADING VOLTAGE NOT REACHED | Indicates that the generator voltage is not above the configured <i>loading voltage</i> after the safety timer. The generator will shutdown. |
| LOADING FREQUENCY NOT REACHED | Indicates that the generator frequency is not above the configured <i>loading frequency</i> after the safety timer. The generator will shutdown. |
| PROTECTIONS DISABLED | Shutdown and electrical trip alarms can be disabled by user configuration. In this case, Protections Disabled will appear on the module display; The alarm text will be displayed but the engine will continue to run. This is 'logged' by the module to allow DSE Technical Staff to check if the protections have been disabled on the module at any time. |
| POSITIVE VAR | Positive VAr has exceeded the trip settings. |
| NEGATIVE VAR | Negative VAr has exceeded the trip settings. |

7.2.3 IDMT ALARM

If the *IDMT Alarm* is enabled, the controller begins following the IDMT 'curve' when the *trip* level is passed. If the *Trip* is surpassed for an excess amount of time the *IDMT Alarm* triggers (*Shutdown* or *Electric trip* as selected in *Action*).

High current shutdown is a latching alarm and stops the Generator.

Remove the fault then press the *Stop/Reset Mode*  button to reset the module.

High current electrical trip is a latching alarm and stops the Generator.

Remove the fault then press the *Stop/Reset Mode*  button to reset the module.

The higher the overload, the faster the trip. The speed of the trip is dependent upon the fixed formula:

$$T = t / ((IA / IT) - 1)^2$$

Where: T is the tripping time in seconds

IA is the actual current of the most highly loaded line (L1 or L2 or L3)

IT is the delayed over-current trip point

t is the time multiplier setting and also represents the tripping time in seconds at twice full load (when IA / IT = 2).

Factory settings for the *IDMT Alarm* when used on a brushless alternator are as follows (screen capture from the DSE Configuration Suite PC software :

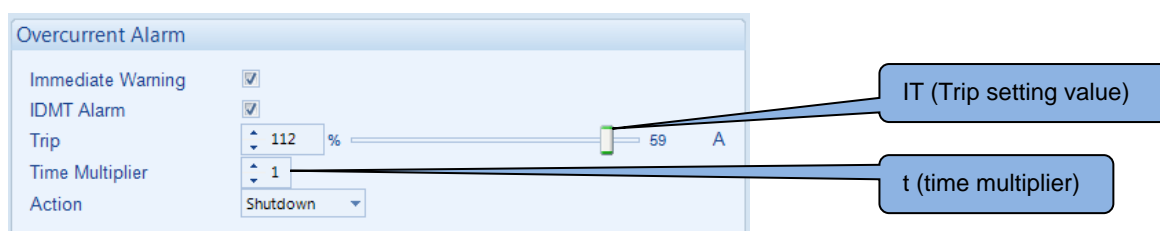

These settings provide for normal running of the generator up to 100% full load. If full load is surpassed, the *Immediate Warning* alarm is triggered, the set continues to run.

The effect of an overload on the generator is that the alternator windings begin to overheat; the aim of the *IDMT alarm* is to prevent the windings being overload (heated) too much. The amount of time that the set can be safely overloaded is governed by how high the overload condition is. With typical settings as above, this allows for overload of the set to the limits of the *Typical Brushless Alternator* whereby 110% overload is permitted for 1 hour.

7.2.4 MAINTENANCE ALARM

The module is configured to display a maintenance alarm after 500 hours. When activated, the maintenance alarm is a warning and the set continues to run.

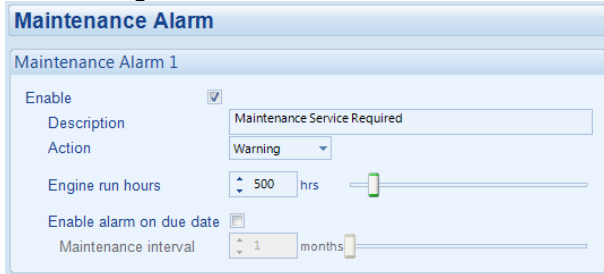

Example



Resetting the maintenance alarm is normally actioned by the site service engineer after performing the required maintenance.

The method of reset is either by:

- Activating an input that has been configured to maintenance 1 reset.
- Pressing the maintenance reset button in the DSE Configuration Suite, Maintenance section.
- Pressing and holding the stop button when the module's display is on the maintenance alarm section.

ACCESSING THE MAIN FRONT PANEL CONFIGURATION EDITOR

Ensure the engine is at rest and the module is in STOP mode by pressing the Stop/Reset  button.

Press the Stop/Reset  and Info  buttons simultaneously.

The module security PIN has been set to 1234, the PIN number request is shown:

Example



Resetting the maintenance alarm is normally actioned by the site service engineer after performing the required maintenance.

The method of reset is either by:

- Activating an input that has been configured to maintenance 1 reset.
- Pressing the maintenance reset button in the DSE Configuration Suite, Maintenance section.
- Pressing and holding the stop button when the module's display is on the maintenance alarm section.



ACCESSING THE MAIN FRONT PANEL CONFIGURATION EDITOR

Ensure the engine is at rest and the module is in STOP mode by pressing the Stop/Reset  button.

Press the Stop/Reset  and Info  buttons simultaneously.

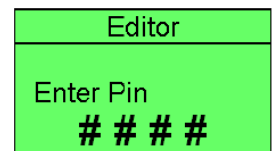
The module security PIN has been set to 1234, the PIN number request is shown:



Press  the first '#' changes to '0'.  Press (up or down) to adjust it to the correct value 1234.

 Press (right) when the first digit is correctly entered. The digit you have just entered will now show '#' for security.



Repeat this process for the other digits of the PIN number. You can press  (left) if you need to move back to adjust one of the previous digits.

When  is pressed after editing the final PIN digit, the PIN is checked for validity. If the number is not correct, you must re-enter the PIN.

If the PIN has been successfully entered (or the module PIN has not been enabled), the editor is displayed:

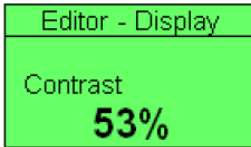

NOTE: The PIN number is not set by DSE when the module leaves the factory. The module has a PIN code set, this has been set by Stephill. If the code has been changed then 'lost' or 'forgotten', the module must be returned to the DSE factory to have the module's code removed. A charge will be made for this procedure. **NB - This procedure cannot be performed away from the DSE factory.**

8 Fault finding 7310

| Symptom | Possible Remedy |
|--|---|
| Unit is inoperative Read/Write configuration does not operate | Check the battery and wiring to the unit. Check the DC supply. Check the DC fuse. |
| Unit shuts down | Check DC supply voltage is not above 35 Volts or below 9 Volts Check the operating temperature is not above 70°C. Check the DC fuse. |
| Unit locks out on Emergency Stop | Check emergency stop switch is functioning correctly. Check Wiring is not open circuit. |
| Warning fault operates | Check relevant switch and wiring of fault indicated on LCD display. Check configuration of input. |
| Fail to Start is activated after pre-set number of attempts to start | Check wiring of fuel solenoid. Check fuel. Check battery supply. Check battery supply is present on the Fuel output of the module. Check the speed sensing signal is present on the 7000 series module's inputs. Refer to engine manual. |
| Continuous starting of generator when in AUTO | Check that there is no signal present on the "Remote Start" input. |
| Generator fails to start on receipt of Remote Start signal. | Check Start Delay timer has timed out. Check signal is on "Remote Start" input. Confirm correct configuration of input is configured to be used as "Remote Start". Check that the oil pressure switch or sensor is indicating low oil pressure to the controller. Depending upon configuration, then set will not start if oil pressure is not low. |
| Pre-heat inoperative | Check wiring to engine heater plugs. Check battery supply. Check battery supply is present on the Pre-heat output of module. |
| Starter motor inoperative | Check wiring to starter solenoid. Check battery supply. Check battery supply is present on the Starter output of module. Ensure that the Emergency Stop input is at Positive. Ensure oil pressure switch or sensor is indicating the "low oil pressure" state to the 7310 series controller. |
| Engine runs but generator will not take load | Check Warm up timer has timed out. Ensure generator load inhibit signal is not present on the module inputs. Check connections to the switching device. Note that the set will not take load in manual mode unless there is an active remote start on load signal. |
| Incorrect reading on Engine gauges | Check engine is operating correctly. Check sensor and wiring paying particular attention to the wiring to terminal 15. |
| Set will not take load | Ensure the generator available LED is lit Check that the output configuration is correct to drive the load switch device and that all connections are correct. Remember that the set will not take load in manual mode unless a remote start on load input is present or the close generator button is pressed. |

9 Fault finding general

| Fault | Action |
|-----------------------------|--|
| High engine temperature | <p>Check Water/Antifreeze level in the radiator.</p> <p>Check for loose wires on the temperature switch & DC loom connector block.</p> <p>Check the continuity of the earth wire. (Refer to wiring diagram)</p> <p>Check radiator surface (both sides) and fins are not obstructed.</p> <p>Check operation of the Temperature switch.</p> <p>Check that the generator air inlets and outlets are not obstructed.</p> <p>Check the fan belt is not damaged, broken or loose. (Refer to handbook)</p> <p><u>Note you may experience low charge if fan belt is loose.</u></p> |
| Low oil pressure | <p>Check Oil level and fill to correct level if necessary</p> <p>Check operation of Oil switch.</p> |
| HZ & Voltage shutdown | <p>Check reset button not tripped and reset if required.</p> <p>Check AC Input at module.</p> <p>Check engine speed is set to 50Hz at no load.</p> <p>Check AC supply from alternator. (If no output refer to alternator handbook)</p> <p>Check fuse on AVR.</p> <p>Check engine has been regularly serviced.</p> |
| No power to control module | <p>Check fuse.</p> <p>Check 12V DC supply to module. If supply present but not operational try new unit.</p> <p>Check battery voltage.</p> <p>Check battery isolator switch is on.</p> <p>Check for loose wires on battery isolator.</p> <p>Check for loose wires on the DC connector plug and socket.</p> <p>Check continuity on +VE and -VE wires to battery.</p> |
| Battery not charging | <p><u>Note you may experience low charge if fan belt is loose.</u></p> <p>Check for loose wires on the DC connector plug / socket & charge alternator.</p> <p>Check continuity of all wires from charge alternator. (Refer to wiring diagram)</p> <p>Check voltage at battery while generator is running, voltage should be 13.4 - 14.4V.</p> <p>Check battery voltage is above 12.5V.</p> |
| Engine not starting | <p>Check Oil level and fill to correct level if necessary.</p> <p>Check fuel level.</p> <p>Check 3 way valves are in correct position. (If fitted)</p> <p>Check operation of fuel lift pump.</p> |
| Glow plugs not operating | <p>Check Emergency stop.</p> <p>Check the fuses.</p> <p>Check battery voltage is above 12.5V.</p> <p>Check for loose wires on the Glow plug, relays, fuses, module terminals, plug and socket.</p> <p>Check -VE supply.</p> <p>Check +VE on Glow plug & trace back to battery via relay.</p> <p>Check +VE on Glow plug & trace back to module via relay, plug & socket.</p> |
| Starter Motor not operating | <p>Check Emergency stop.</p> <p>Check the fuses.</p> <p>Check battery voltage is above 12.5V.</p> |
| Starter Motor not operating | <p>Check for loose wires on the solenoid, relays, fuses, module terminals, plug and socket.</p> <p>Check +VE supply from battery to starter motor via isolator switch.</p> <p>Check -VE supply.</p> <p>Check start terminal on Starter motor & trace back to module via relay, plug & socket.</p> |
| Fuel solenoid not operating | <p>Does the Fuel solenoid energises when the starter motor turns over.</p> <p>Check Emergency stop.</p> <p>Check the fuses.</p> <p>Check battery voltage is above 12.5V.</p> <p>Check for loose wires on the solenoid, relays, fuses, module terminals, plug and socket.</p> <p>Check -VE supply.</p> <p>Check +VE on Fuel solenoid & trace back to battery via relay.</p> <p>Check +VE on Fuel solenoid & trace back to module via relay, plug & socket.</p> |

10 SPARES

10.1 Perkins consumable spares

Owing to the amount of times Perkins amends the parts they fit to each engine we will require the full engine build list and serial number. The build list number is generally two letters followed by five numbers with the serial number usually beginning with a J, N or a U followed by six numbers and a final letter. E.g.: AA12345U123456X.

Usually the part numbers are on the filters or in the case of air filters on the air cleaner cover.

We have implemented writing the part numbers to the test sheet should the numbers become illegible in which case quote the Stephill Generators serial number.

10.2 General spares

| Part Number | Description |
|-------------|--|
| 011-0002 | 1104D-E44TAG2 ENGINE |
| 018-0076 | ALTERNATOR ECP34-2S/4 105KVA SAE3 -11.5 |
| 016-0125 | LIFTING EYE |
| 016-0539 | REACTIVE SILENCER SSDP120 |
| 016-0540 | ABSORPTION SILENCER SSDP120 |
| 016-0541 | MANIFOLD PIPE SSDP120 |
| 016-1093 | RAIN CAP 3" |
| 027-0064 | U CLAMP 67mm |
| 027-0078 | U CLAMP 80mm |
| 036-0039 | MCB/COVER 4 MODULE |
| 036-0074 | EARTH LEAKAGE RELAY ELR-3C |
| 036-0106 | NM8 250S (FRAME) 200A 3POLE MCCB |
| 036-0108 | 125A 3 POLE MCB |
| 036-0109 | 63A 3 POLE MCB |
| 036-0110 | 32A 3 POLE MCB |
| 036-0111 | 32A 1 POLE MCB |
| 036-0112 | 16A 1 POLE MCB |
| 038-0114 | HARD WIRE TERMINAL TWIN POST |
| 038-0115 | HARD WIRE DIVIDER |
| 038-0116 | HARD WIRE END BRACKET |
| 043-0017 | RCD BYPASS SWITCH |
| 044-0002 | SOCKET 230V 16A |
| 044-0004 | SOCKET 230V 32A |
| 044-0014 | SOCKET 400V 32A |
| 044-0026 | SOCKET 400V 63A |
| 044-0087 | SOCKET 125A 415V 5 PIN |
| 045-0043 | LED PILOT LAMP 22mm RAD224P RED 230V |
| 045-0075 | CT 200/5A |
| 045-0101 | TORDAIL TRANSFORMER CT-1/60 |
| 016-1018 | T/LL140 LEVEL SENSOR 275MM, 10-180, SAE 5 HOLE |
| 016-1051 | LIQUID LEVEL SENSOR S85/04 P RANGE |
| 036-0061 | FUSE HOLDER 0-377-00 |
| 036-0066 | FUSE HOLDER 0-376-60 IN LINE |
| 036-0079 | 2AMP FUSE 537-1177 |
| 036-0100 | FUSE 3.15A (541-4690) ANTI SURGE |
| 036-0101 | FUSE 30AMP 0-377-30 MAXI BLADE |
| 036-0104 | FUSE 541-3108A (5amp) |
| 036-0105 | 25AMP FUSE 0-375-25 |
| 036-0113 | FUSE 80amp 0-377-80 Maxi |
| 036-1050 | BBTECCT35 CONNECTION TERMINAL 35mm |
| 036-1051 | BBTECEC3P16 END CAP 3 PHASE BUS BAR |
| 036-1052 | BBTEC3PPIN16 3 PHASE BUSBAR |
| 038-0107 | TERMINAL BATTERY POSITIVE 1-017-01 |
| 038-0108 | TERMINAL BATTERY NEGATIVE 2-017-01 |
| 038-0307 | 12 WAY TERMINAL BLOCK MALE 0-013-06 |
| 038-0308 | 12 WAY TERMINAL BLOCK FEMALE 0-013-16 |
| 043-0033 | PROXIMITY SWITCH 613-8202 |
| 045-0018 | E/STOP |

| Part Number | Description |
|-------------|---|
| 045-0020 | ISOLATOR SWITCH BATTERY 0/605/00 |
| 045-0024 | PUSH BUTTON RCAS-PBF6 BLUE |
| 045-0025 | CONTACT BLOCK RAS-CB NO N/O |
| 045-1031 | CA741/4 4 WAY INSULATED PRE ASSEMBLED |
| 045-2008 | DEEP SEA CONTROLLER 7310 AUTOSTART |
| 046-0063 | BELDEN 9841 - LSF ALTERNATIVE CABLE |
| 047-0012 | WELDING / BAT CABLE 50mm |
| 054-0010 | BATTERY 663 (778CCA - 105AH) SSDP33/50/70 |
| 056-0002 | RELAY 4 PIN SR/1A 12VDC |
| 056-0004 | RELAY HOLDER 70-100 AMP (3-729-01) |
| 056-0005 | RELAY HOLDER 30-40AMP (3-729-00) |
| 056-0012 | MINI RELAY MAKE/BREAK 100A 0-727-72 |
| 016-2115 | SSDP120A CANOPY C/W BASE & TANK |
| 016-0132 | SSDP RANGE RADIATOR FLAP |
| 016-0237 | BATTERY BRACKET |
| 016-0253 | DOOR STOP |
| 016-0254 | SSDP30/70 MK2 CONTROL PANEL DOOR CATCH |
| 016-0255 | SSDP30/70 MK2 HARDWIRE DOOR STRIKER |
| 016-0265 | HINGE SPACER |
| 016-0290 | BATTERY ISOLATOR SWITCH BRACKET |
| 016-0312 | EARTH BAR |
| 016-1016 | HINGE M5 x12 |
| 016-1024 | P RANGE BUFFER 6007102 |
| 016-1050 | MOULDED EMERGENCY STOP PAN |
| 016-1081 | SHAPED WEATHERPROOF PADDLE |
| 016-1086 | MALE DOOR HOLDER 0666/002 |
| 016-1087 | FEMALE PLAIN DOOR HOLDER 0666/001 |
| 022-1029 | KNOB M6 X 16 |
| 022-3051 | OVAL SLOT STUD |
| 023-0257 | STRIKE DOOR CATCH |
| 023-1000 | HINGE M8 X 14.5 |
| 023-1019 | CAM 28mm RAD LOCK 1000/28 |
| 023-1020 | INSERT SLOT 2X4 RAD LOCK 1000/U142 |
| 023-1021 | HOUSING RAD/LOCK 1000/U223 |
| 023-1027 | DOOR HINGE M8 |
| 023-1029 | HINGE RADIATOR FLAP 1110/U24 |
| 024-1001 | HANDLE SLAM LOCK CONTROL PANEL |
| 027-0066 | P CLIP 20mm |
| 027-0077 | MOUNT BRB 110 C60 M12 |
| 045-0004 | KEY |
| 048-0008 | FILLER CAP |
| 016-0300 | SSD30-70 FUEL TANK GASKET |

11 SERVICE AND MAINTENANCE

IMPORTANT WARNING:

After any service on the generator, ensure that all piping and electrical cables are correctly routed and secured away from hot parts. Failure to observe this warning may result in damage to the piping and cables which could result in a fire.

Do not service or work on generator whilst the engine is running. Ensure battery isolator switch is in the off position when working on generator, this will prevent generator from starting.

11.1 Engine service

Service the engine strictly in accordance with the instructions given in the relevant operator manual / handbook. An approved specialist must carry out any maintenance. Any spare parts required should be of genuine manufacturer's origin. Note: failure to adhere to manufacturer's recommended service schedules may invalidate the warranty. Please consult engine operator's manual for full service intervals.

https://www.perkins.com/en_GB/aftermarket/operation-maintenance-manuals.html#FAQs

Daily

Alternator and Fan Belts - Inspect/Adjust/
Replace Cooling System Coolant Level - Check
Driven Equipment - Check
Engine Air Cleaner Service Indicator - Inspect
Engine Oil Level - Check
Fuel System Primary Filter/Water Separator -
Drain
Walk-Around Inspection

Every 50 Service Hours or Weekly

Fuel Tank Water and Sediment - Drain

Every 500 Service Hours or 1 Year

Battery Electrolyte Level - Check
Engine Air Cleaner Element (Dual Element) -
Clean/Replace
Engine Air Cleaner Element (Single Element) -
Inspect/Replace
Engine Ground - Inspect/Clean
Engine Oil and Filter - Change
Fuel System Primary Filter (Water Separator) drain
Element - Replace
Fuel System Secondary Filter - Replace
Hoses and Clamps - Inspect/Replace

Every 1000 Service Hours

Engine Valve Lash - Inspect/Adjust

11.2 Light Load Operation

If an engine is operated on load less than 25-30% of its rated output, certain symptoms will be observed which may be cause for concern. The engine is designed to run up to a maximum power and so the size of the piston, the wall loading of the piston rings, etc are designed to cope with this.

When an engine is run at light load then the energy put into the cylinder is low and consequently the cylinder pressure is lower and so is the temperature. The result is the piston is not such a good fit in the bore, with increased clearance, allowing more oil to pass the piston and be burnt, which is indicated by high oil consumption.

With lower pressures the sealing capacity of the rings is lower, also it is not ideal for bedding in the rings and can cause bore glazing, which ruins all control.

On turbocharged engines oil will start to appear from the manifolds from the bearing arrangement in the turbocharger.

Turbochargers are fitted to an engine to increase power by supplying more air to the cylinders. When running a turbocharger, air is sucked in, which can have vacuum levels up to 500kPa, with pressure ratios of 3 : 1. The compressor seals are designed to work most efficiently when the turbocharger compressor is operating at its' most efficient point. If the engine is running at low powers then the turbocharger is running at low speed (no energy from the exhaust because the fuel inlet to the engine is low) and the inlet vacuum is low resulting in poor turbocharger seal loading and pull over of oil from the bearing assembly. This oil is mixed with the air and pumped into the manifolds where some separates from the air when it collides with the inside of the manifold. If the joints are not air tight the oil will leak out.

Black smoke will be produced from the exhaust outlets, due to poor combustion at light load, as excess fuel is pumped through into the exhaust system, resulting in soot being expelled into the exhaust system.

A further result is that abnormal carbon build-up on the valves, piston crowns and exhaust ports. Thus the normal service interval between top overhauls may be reduced. Fuel dilution of the lubricating oil will also occur.

It is therefore recommended that the following precautions are observed :-

Every 2000 Service Hours

Aftercooler Core - Inspect
Alternator - Inspect
Engine Mounts - Inspect
Starting Motor - Inspect
Turbocharger - Inspect
Water Pump - Inspect

Every 2 Years

Cooling System Coolant - Change
Every 3000 Service Hours
Fuel Injector - Test/Change

Every 3000 Service Hours or 2 Years

Cooling System Coolant (Commercial Heavy-Duty) -
Change

Every 4000 Service Hours

Aftercooler Core - Clean/Test

Every 6000 Service Hours or 3 Years

Cooling System Coolant Extender (ELC) - Add

Every 12 000 Service Hours or 6 Years

Cooling System Coolant (ELC) - Change

- Running on light load should be avoided or reduced to a minimum period. If weekly exercising on no load is carried out, the running period should be kept down to maximum 15 minutes or until the battery charge rate returns to normal.
 - Every year the engine / generating set should be run on full load for four (4) hours, to burn off accumulations of carbon in the engine and exhaust system. This may require a “dummy” load. The load should be built-up gradually from zero over the four hour run.
- Operating this generator at light loads for long periods can result in carbon build up in the engine, which could cause overheating, poor efficiency and excessive smoking. High levels of carbon in the exhaust outlet and reduced diameter of tail pipe will be an indicator of this, please call Perkins for further information.

11.3 Alternator service

Brushless alternators employed on Stephill Generators are maintenance free. Service must be carried out by competent qualified personnel strictly in accordance with the instructions given in the handbook. Any spare parts required should be of genuine manufacturer’s origin. <http://www.meccalte.com/>

12 WARRANTY

All equipment supplied by STEPHILL GENERATORS LTD carries a warranty of 12 months from date of despatch.

During the warranty period, should the plant fail due to faulty design, materials or workmanship by STEPHILL GENERATORS LTD or its sub-contractors, we undertake to rectify the fault.

STEPHILL GENERATORS LTD will accept no responsibility whatsoever for equipment that has failed due to;

- Operation with incorrect fuel, lubricating oil or coolant.
- Improper repair or use of parts not supplied by STEPHILL GENERATORS LTD.
- Lack of, or incorrect maintenance.
- Fair wear and tear, misuse, negligence, accidental damage, improper storage, incorrect starting / warm-up / run-in or shutdown.

No warranty claim will be considered by STEPHILL GENERATORS LTD unless any defective parts are available for inspection by us, or our nominees, to determine the reason or cause of failure, and STEPHILL GENERATORS LTD is given the option of repair or replacement.

STEPHILL GENERATORS LTD are not responsible for incidental or consequential damages, downtime, or other costs due to warrantable failure, and unauthorised alterations made to any product supplied by STEPHILL GENERATORS LTD.

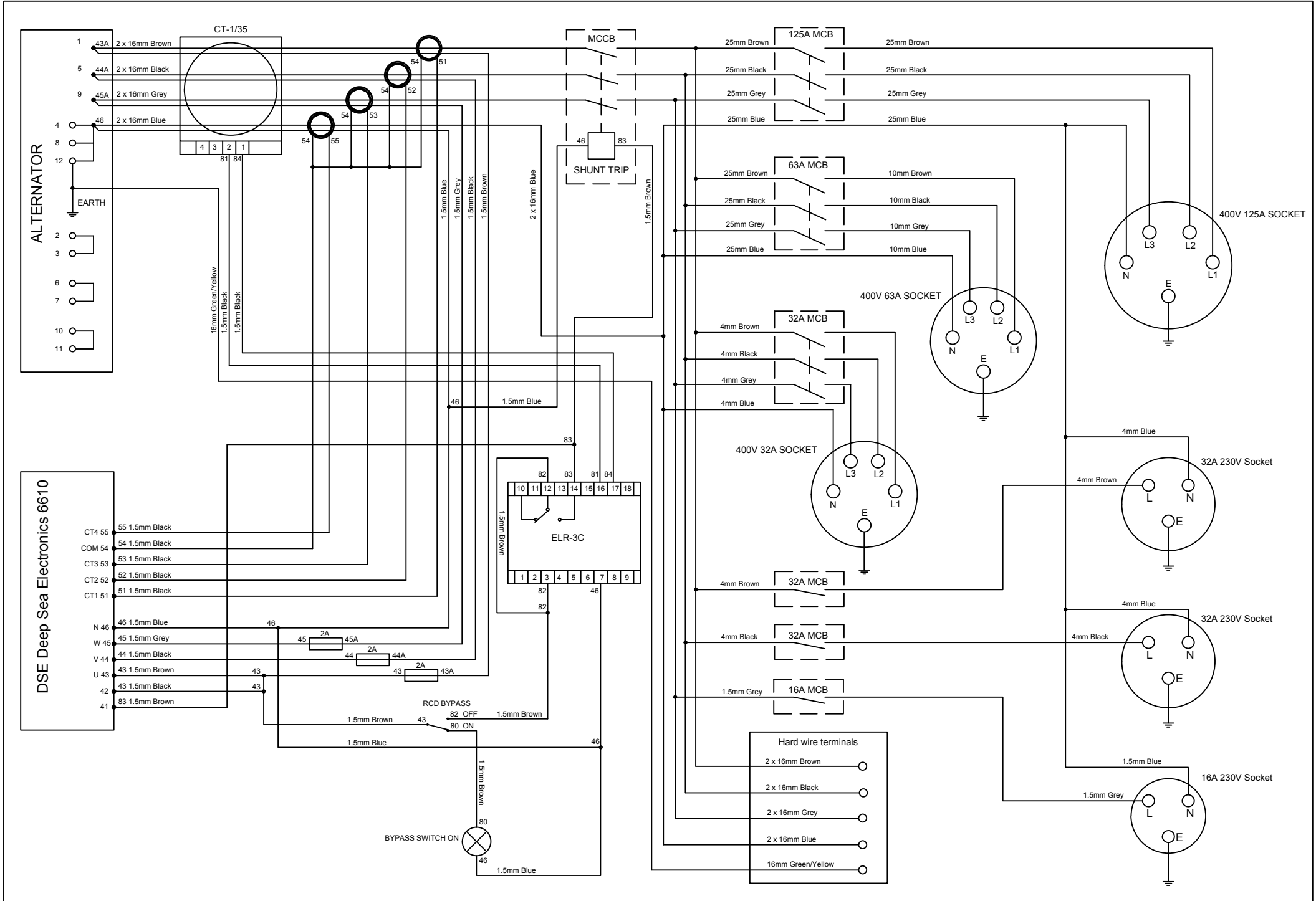

| | | | | | | |
|---|---------------------------|--|------------------------|------------|------------------|--------------------------|
|  STEPHILL GENERATORS Phone 01933 677911 Fax 01933 677916 | Drawing Number SW30043 | Description 117kVA 3 Phase wiring with Deep Sea 7310 1 x 125/63/32A 400v & 3 x 32A, 1 x 16A 230V sockets & variable RCD | Last Number Used 95 | Issue A | Date 14-12-15 | Revision New drawing. |
| | Drawn R Golding | | | | | |

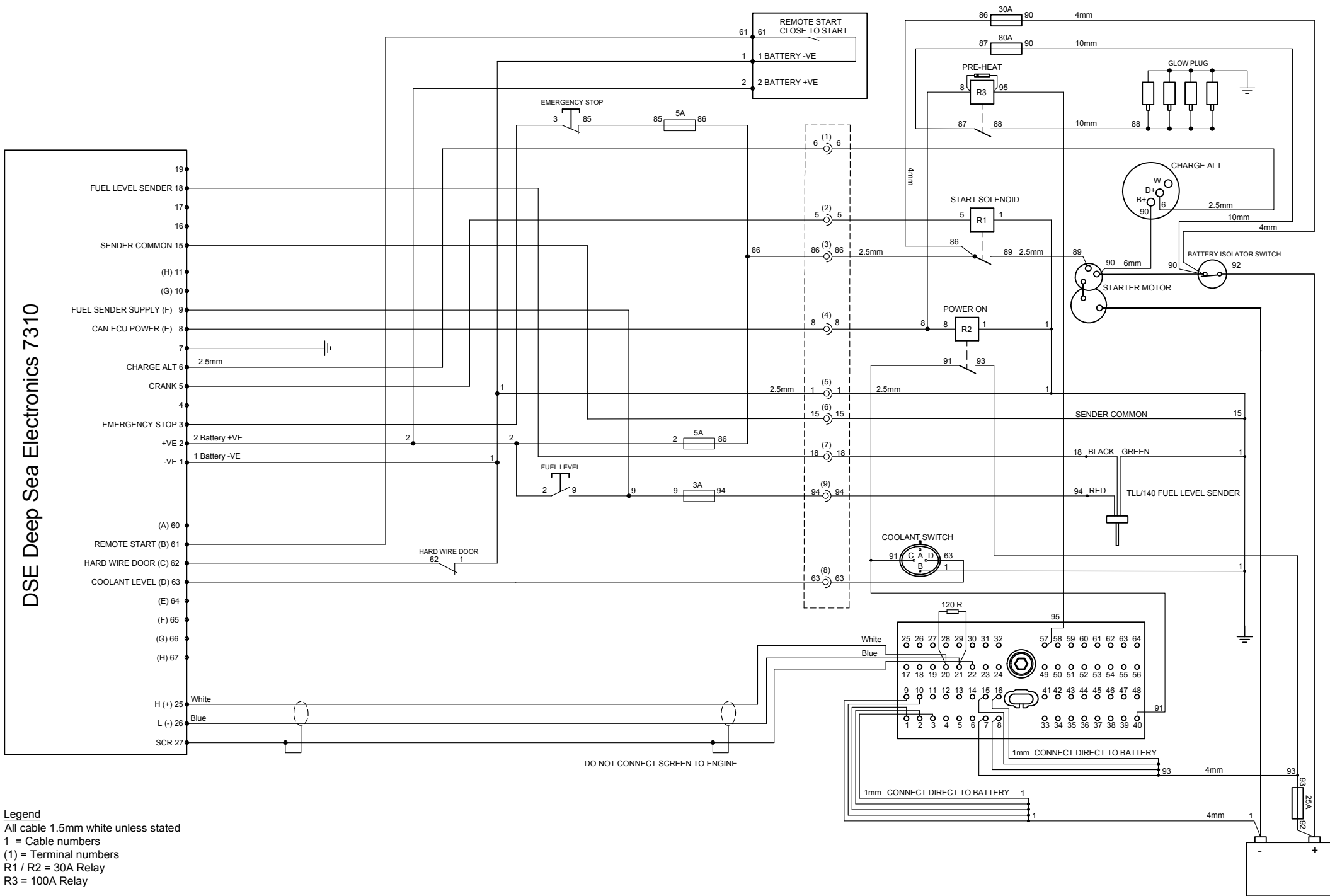

Legend
 All cable 1.5mm white unless stated
 1 = Cable numbers
 (1) = Terminal numbers
 R1 / R2 = 30A Relay
 R3 = 100A Relay

| | | | | | | |
|--|---------------------------|--|------------------------|------------|------------------|--------------------------|
|  STEPHILL GENERATORS Phone 01933 677911 Fax 01933 677916 | Drawing Number SW17018 | Description Perkins 1100 Series ECU Deep Sea 7310 | Last Number Used 97 | Issue A | Date 14-12-15 | Revision New drawing. |
| | Drawn R Golding | | | | | |

| SSDP120 Canopy | | | |
|----------------------------|---------|---|-----|
| Item | Part No | Description | Qty |
| 1 | 16-501 | SSDP120 Roof | 1 |
| 2 | 16-524 | SSDP120 Engine non service side panel | 1 |
| 3 | 16-132 | SSD30 Radiator flap | 1 |
| 4 | 16-503 | SSDP120 Door right hinged | 2 |
| 5 | 16-507 | SSDP120 Door pillar | 2 |
| 6 | 16-504 | SSDP120 Door left hinged | 2 |
| 7 | 16-505 | SSDP120 Door air inlet duct | 4 |
| 8 | 16-522 | SSDP120 Control panel rain guard | 1 |
| 9 | 16-519 | SSDP120 Alternator non service side panel | 1 |
| 10 | 16-516 | SSDP120 Non service side plate | 1 |
| 11 | 16-533 | SSDP120 Lifting beam | 1 |
| 12 | 16-125 | SSDP120 Lifting eye | 1 |
| 13 | 16-528 | SSDP120 Battery tray | 1 |
| 14 | 16-509 | SSDP120 Alternator channel | 1 |
| 15 | 16-529 | SSDP120 Fuel tank | 1 |
| 16 | 16-514 | SSDP120 Alternator end panel | 1 |
| 17 | 16-521 | SSDP120 Control box | 1 |
| 18 | 16-254 | SSD30 MK2 Control panel door catch | 1 |
| 19 | 16-513 | SSDP120 Socket panel housing | 1 |
| 20 | 16-536 | SSDP120 Socket panel 1 x 125 1 x 63 3 x 32 1 x 16 | 1 |
| 21 | 16-523 | SSDP120 Hard wire box | 1 |
| 22 | 16-535 | SSDP120 Hard wire 250A MCCB plate | 1 |
| 23 | 16-517 | SSDP120 Control panel door | 1 |
| 24 | 16-512 | SSDP120 Hard wire door | 1 |
| 25 | 16-527 | SSDP120 Radiator door | 1 |
| 26 | 16-511 | SSDP120 Bund blank plate | 1 |
| 27 | 16-506 | SSDP120 Perkins 1104 radiator plate | 1 |
| 28 | 16-530 | SSD110 Air outlet deflector plate | 1 |
| 29 | 16-510 | SSDP120 Engine channel | 1 |
| 30 | 16-552 | SSDP120 Silencer bracket | 1 |
| 31 | 16-548 | SSDP120 Fuel tank inspection plate | 1 |
| 32 | 16-525 | SSDP120 Engine service side panel | 1 |
| 33 | 16-500 | SSDP120 Base | 1 |
| 34 | 16-508 | SSDP120 Door base | 2 |
| 35 | 16-518 | SSDP120 Alternator service side panel | 1 |
| 36 | 16-515 | SSDP120 Alternator service side plate | 1 |
| 37 | 16-253 | SSD30 MK2 Control panel door stop | 2 |
| 38 | 16-520 | SSDP120 Cable inlet plate | 1 |
| 39 | 16-526 | SSDP120 Cable clamp | 1 |
| 40 | 16-550 | SSDP120 Hard wire door plate | 1 |
| Not shown on exploded view | | | |
| | 16-551 | SSDP120 Perkins fuel filter bracket | 1 |
| | 16-582 | SSDP120 6 Way diverter valve bracket | 1 |
| | 16-534 | SSDP120 Control panel | 1 |
| | 16-538 | SSDP120 250A MCCB bracket | 1 |
| | 16-502 | SSDP120 Roof foam bracket | 2 |
| | 16-265 | SSD30 MK2 Hinge spacer | 4 |
| | 16-290 | SSD30 MK2 Battery isolator bracket | 1 |
| | 16-255 | SSD30 MK2 Hard wire door striker | 1 |
| | 16-237 | SSDP120 Battery bracket mark 2 | 1 |
| | 16-586 | SSDP120 Quick release valve plate | 1 |

