



A TEREX BRAND

# *Operator's Manual*

**GS-2669DC**  
**GS-3369DC**  
**GS-4069DC**

CE

with  
Maintenance  
Information

Original Instructions  
First Edition  
Fifth Printing  
Part No. 237929

---

## Important

Read, understand and obey these safety rules and operating instructions before operating this machine. Only trained and authorized personnel shall be permitted to operate this machine. This manual should be considered a permanent part of your machine and should remain with the machine at all times. If you have any questions, contact us.

---

## Contact Us:

Internet: [www.genielift.com](http://www.genielift.com)

E-mail: [awp.techpub@terex.com](mailto:awp.techpub@terex.com)

---

## Contents

Introduction .....	1
Symbol and Hazard Pictorials Definitions.....	3
General Safety .....	5
Personal Safety.....	7
Work Area Safety.....	8
Legend .....	16
Controls.....	17
Inspections.....	21
Operating Instructions.....	36
Transport and Lifting Instructions .....	47
Maintenance .....	50
Specifications.....	52

---

Copyright © 2011 Terex Corporation

First Edition: Fifth Printing, October 2014

Genie is a registered trademark of Terex South Dakota, Inc. in the U.S.A. and many other countries. "GS" is a trademark of Terex South Dakota, Inc.

 Complies with EC Directive 2006/42/EC  
See EC Declaration of Conformity

# Introduction

## Owners, Users and Operators:

Thank you for choosing our machine for your application. Our number one priority is user safety, which is best achieved by our joint efforts. We feel that you make a major contribution to safety if you, as the equipment users and operators:

- 1 **Comply** with employer, job site and governmental rules.
- 2 **Read, understand and follow** the instructions in this and other manuals supplied with this machine.
- 3 **Use good safe work practices** in a commonsense way.
- 4 **Only have trained/certified operators**, directed by informed and knowledgeable supervision, running the machine.



---

## Danger

Failure to obey the instructions and safety rules in this manual will result in death or serious injury.

---

## Do Not Operate Unless:

- You learn and practice the principles of safe machine operation contained in this operator's manual.
  - 1 **Avoid hazardous situations.**  
**Know and understand the safety rules before going on to the next section.**
    - 2 Always perform a pre-operation inspection.
    - 3 Always perform function tests prior to use.
    - 4 Inspect the workplace.
    - 5 Only use the machine as it was intended.
- You read, understand and obey the manufacturer's instructions and safety rules—safety and operator's manuals and machine decals.
- You read, understand and obey employer's safety rules and worksite regulations.
- You read, understand and obey all applicable governmental regulations.
- You are properly trained to safely operate the machine.

# Introduction

## Hazard Classification

Decals on this machine use symbols, color coding and signal words to identify the following:



Safety alert symbol—used to alert you to potential personal injury hazards. Obey all safety messages that follow this symbol to avoid possible injury or death.

### **⚠ DANGER**

Indicates a hazardous situation which, if not avoided, will result in death or serious injury.

### **⚠ WARNING**

Indicates a hazardous situation which, if not avoided, could result in death or serious injury.

### **⚠ CAUTION**

Indicates a hazardous situation which, if not avoided, could result in minor or moderate injury.

### **NOTICE**

Indicates a property damage message.













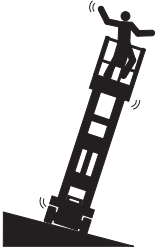
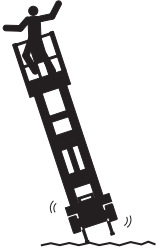
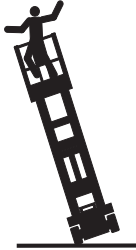
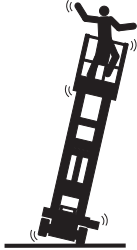
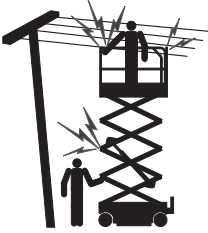

## Intended Use

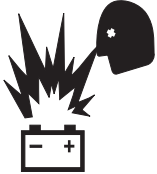
This machine is intended to be used only to lift personnel, along with their tools and materials to an aerial work site.

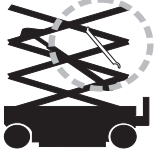
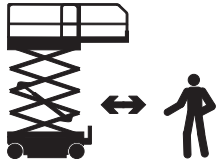
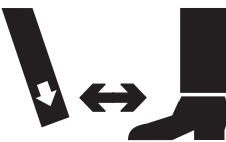











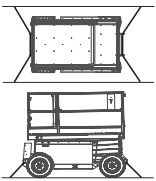

## Safety Sign Maintenance

Replace any missing or damaged safety signs. Keep operator safety in mind at all times. Use mild soap and water to clean safety signs. Do not use solvent-based cleaners because they may damage the safety sign material.

## Symbol and Hazard Pictorials Definitions

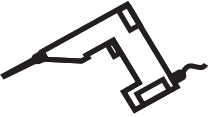
				
Read the operator's manual	Read the service manual	Crush hazard	Crush hazard	Collision hazard
				
Tip-over hazard	Tip-over hazard	Tip-over hazard	Tip-over hazard	Electrocution hazard
				
Electrocution hazard	Explosion hazard	Fire hazard	Burn hazard	Skin injection hazard
				
Engage safety arm	Keep away from moving parts	Keep clear of outriggers and tires	Move machine to level ground	Close chasis tray
				
Lower the platform	Do not set up where it cannot be leveled with outriggers	Maintain required clearance	Only trained maintenance personnel should access compartments	Use a piece of cardboard or paper to search for leaks

# Symbol and Hazard Pictorials Definitions

 <p>Chock the wheels</p>	 <p>Release brakes</p>	 <p>Tiedown</p>	 <p>Lanyard anchorage points</p>	 <p>No smoking</p>
 <p>Wheel load</p>	 <p>Transport diagram</p>	 <p>Side force</p>	 <p>Wind speed</p>	 <p>Outrigger load</p>
 <p>Voltage rating for power to platform</p>	 <p>Pressure rating for air line to platform</p>	 <p>Maximum capacity</p>	 <p>Crushing hazard</p>	
 <p>Hold rail while lowering</p>				

# General Safety

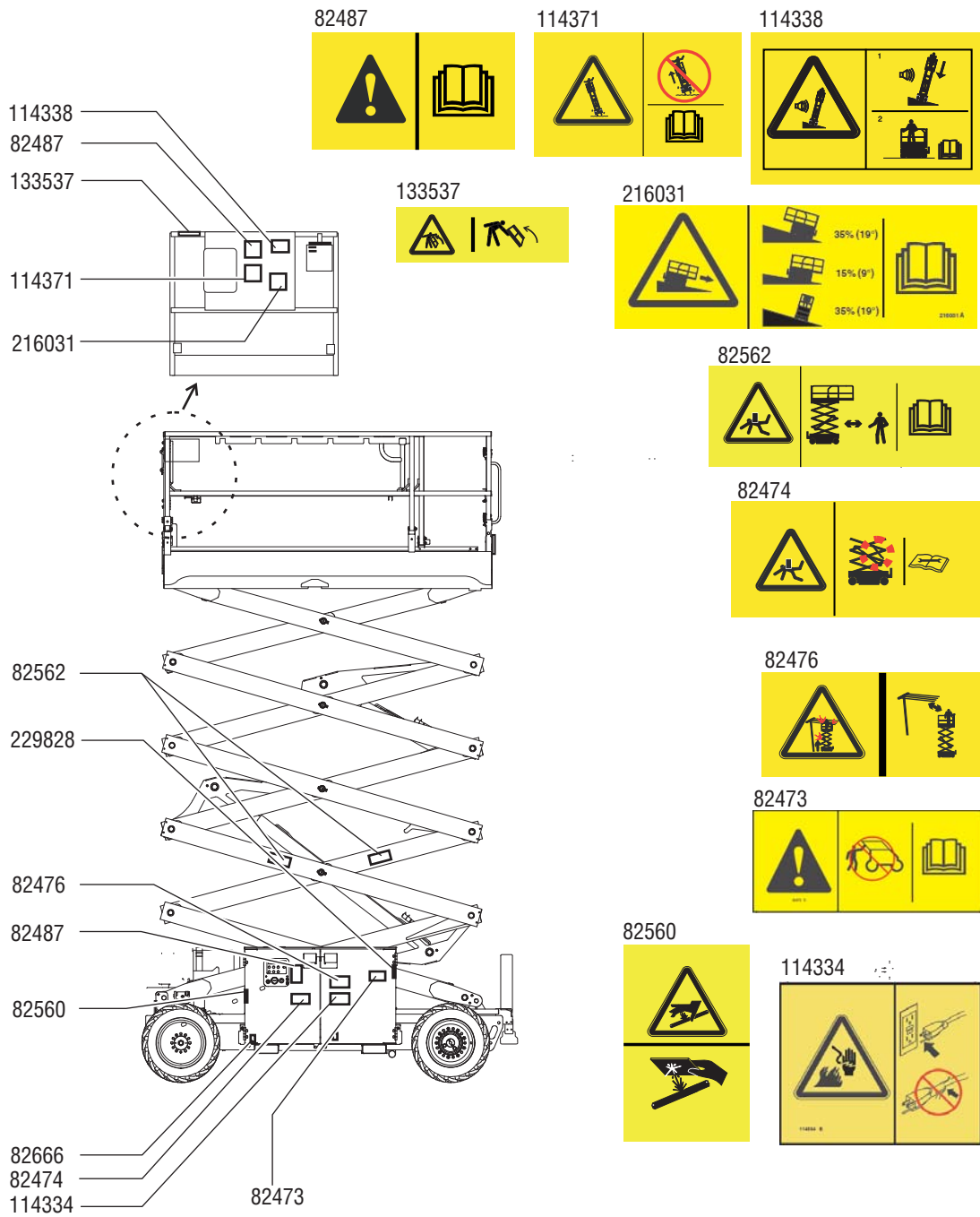

# General Safety

82475



82562

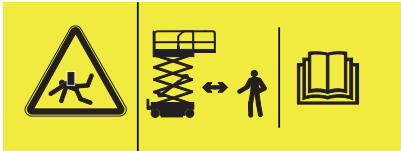

82473



82474



82481



114337

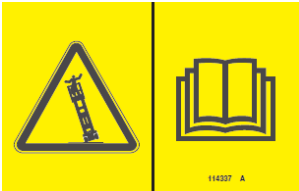

237924



237925



82475

82475

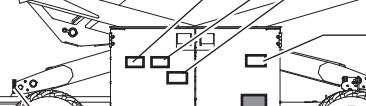
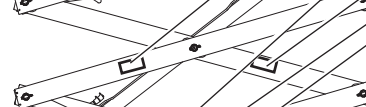
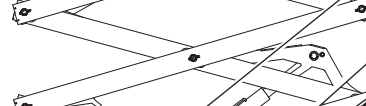
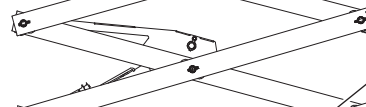
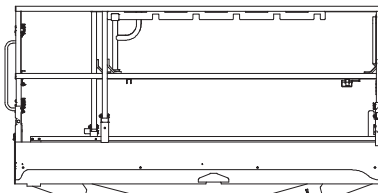
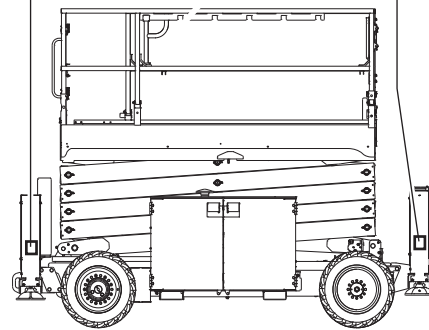

82562

82476

82562

82474

82473

237924  
or 237925

82481

114337



---

# Personal Safety

## Personal Fall Protection

Personal fall protection equipment (PFPE) is not required when operating this machine. If PFPE is required by job site or employer rules, the following shall apply:

All PFPE must comply with applicable governmental regulations and must be inspected and used in accordance with the manufacturer's instructions.

# Work Area Safety

## ⚠ Electrocuting Hazards

This machine is not electrically insulated and will not provide protection from contact with or proximity to electrical current.



Obey all local and governmental regulations regarding required clearance from electrical power lines. At a minimum, the required clearance contained in the chart below must be followed.

Line Voltage	Required Clearance
0 to 50KV	3.05 m
50 to 200KV	4.60 m
200 to 350KV	6.10 m
350 to 500KV	7.62 m
500 to 750KV	10.67 m
750 to 1000KV	13.72 m

Allow for platform movement, electrical line sway or sag, and beware of strong or gusty winds.



Keep away from the machine if it contacts energized power lines. Personnel on the ground or in the platform must not touch or operate the machine until energized power lines are shut off.

Do not operate the machine during lightning or storms.

Do not use the machine as a ground for welding.

## ⚠ Tip-over Hazards

Occupants, equipment and materials shall not exceed the maximum platform capacity or the maximum platform capacity of the platform extension.

### Maximum capacity – GS-2669DC

Platform retracted	680 kg
Platform extended – Platform only	544 kg
Platform extended – Extension only	136 kg
Maximum occupants	4



680 kg



136 kg

544 kg

### Maximum capacity – GS-3369DC

Platform retracted	454 kg
Platform extended – Platform only	318 kg
Platform extended – Extension only	136 kg
Maximum occupants	4



454 kg



136 kg

318 kg

# Work Area Safety

Maximum capacity – GS-4069DC	
Platform retracted	363 kg
Platform extended – Platform only	227 kg
Platform extended – Extension only	136 kg
Maximum occupants	3



363 kg



136 kg

227 kg



Do not raise the platform unless the machine is on a firm, level surface.



Do not depend on the tilt alarm as a level indicator. The tilt alarm sounds on the chassis only when the machine is on a severe slope.

If the tilt alarm sounds:

Lower the platform. Move the machine to a firm, level surface. If the tilt alarm sounds when the platform is raised, use extreme caution to lower the platform.

Do not alter or disable the limit switches.

Do not drive over 0.48 km/h with the platform raised.

**Outdoor Use:** Do not raise the platform when wind speeds may exceed 12.5 m/s. If wind speeds exceed 12.5 m/s when the platform is raised, lower the platform and do not continue to operate the machine.

**Indoor Use:** When raising the platform, follow ratings for allowable side force and number of occupants on the next page.



Do not operate the machine in strong or gusty winds. Do not increase the surface area of the platform or the load. Increasing the area exposed to the wind will decrease machine stability.



Use extreme care and slow speeds while driving the machine in the stowed position across uneven terrain, debris, unstable or slippery surfaces and near holes and drop-offs.

## Work Area Safety

Do not use the platform controls to free a platform that is caught, snagged or otherwise prevented from normal motion by an adjacent structure. All personnel must be removed from the platform before attempting to free the platform using the ground controls.

Do not drive the machine on or near uneven terrain, unstable surfaces or other hazardous conditions with the platform raised.

Do not use the machine as a crane.

Do not push the machine or other objects with the platform.

Do not contact adjacent structures with the platform.

Do not tie the platform to adjacent structures.

Do not place loads outside the platform perimeter.



Do not push off or pull toward any object outside of the platform.

---

### Maximum allowable manual force

---

#### GS-2669DC

Indoor use only – 4 person	400 N
Outdoor use – 4 person	400 N

#### GS-3369DC

Indoor use only – 4 person	400 N
Outdoor use – 2 person	400 N

#### GS-4069DC

Indoor use only – 3 person	400 N
Outdoor use – 2 person	400 N

Do not alter or disable machine components that in any way affect safety and stability.

Do not replace items critical to machine stability with items of different weight or specification.

Do not modify or alter an aerial work platform without prior written permission from the manufacturer. Mounting attachments for holding tools or other materials onto the platform, toeboards or guard rail system can increase the weight in the platform and the surface area of the platform or the load.

# Work Area Safety



Do not place or attach fixed or overhanging loads to any part of this machine.



Do not place ladders or scaffolds in the platform or against any part of this machine.

Do not transport tools and materials unless they are evenly distributed and can be safely handled by person(s) in the platform.

Do not use the machine on a moving or mobile surface or vehicle.

Be sure all tires are in good condition, castle nuts are properly tightened and cotter pins are properly installed.

Do not use batteries that weigh less than the original equipment. Batteries are used as counterweight and are critical to machine stability. For GS-4069 machine, each battery must weigh 39.9 kg. For each GS-2669 and GS-3369 machine with high capacity battery option, each battery must weigh 39.9 kg.

For GS-2669 and GS-3369 machines with the standard battery option, each battery must weigh 28.1 kg.

## ⚠️ Crushing Hazard

Keep hands and limbs out of scissors.

Keep hands clear when folding rails.



Do not work under the platform or in the scissor links without the safety arm in place.

Use common sense and planning when operating the machine with the controller from the ground. Maintain safe distances between the operator, the machine and fixed objects.

## ⚠️ Operation on Slopes Hazards

Do not drive the machine on a slope that exceeds the maximum uphill, downhill or side slope rating of the machine. Slope rating applies only to machines in the stowed position.

### Maximum slope rating, stowed position

	Extension deck uphill	35% (19°)
	Extension deck downhill	15% (9°)
	Side slope	35% (19°)

Note: Slope rating is subject to ground conditions and adequate traction.

## Work Area Safety

### ▲ Fall Hazards

The guard rail system provides fall protection. If occupant(s) of the platform are required to wear personal fall protection equipment (PFPE) due to job site or employer rules, PFPE and its use shall be in accordance with the PFPE manufacturer's instructions and applicable governmental requirements. Attach the lanyard to the anchor provided in the platform.



Do not sit, stand or climb on the platform guard rails. Maintain a firm footing on the platform floor at all times.



Do not climb down from the platform when raised.

Keep the platform floor clear of debris.

Do not enter or exit the platform unless the machine is in the stowed position.

Attach the platform entry chain or close the entry gate before operating.

Do not operate the machine unless the guard rails are properly installed and the entry is secured for operation.

### ▲ Collision Hazards

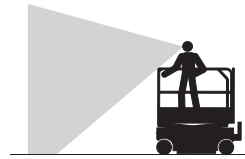

Be aware of limited sight distance and blind spots when driving or operating.

Be aware of extended platform position when moving the machine.

The machine must be on a level surface or secured before releasing the brakes.

Operators must comply with employer, job site and governmental rules regarding use of personal protective equipment.



Check the work area for overhead obstructions or other possible hazards.



Be aware of crushing hazards when grasping the platform guard rail.

## Work Area Safety

Observe and use color-coded direction arrows on the platform controls and the platform decal plate for drive and steer functions.



Do not lower the platform unless the area below is clear of personnel and obstructions.



Limit travel speed according to the condition of the ground surface, congestion, slope, location of personnel, and any other factors which may cause collision.

Do not operate a machine in the path of any crane or moving overhead machinery unless the controls of the crane have been locked out and/or precautions have been taken to prevent any potential collision.

No stunt driving or horseplay while operating a machine.

### ⚠ Bodily Injury Hazard

Do not operate the machine with a hydraulic oil or air leak. An air leak or hydraulic leak can penetrate and/or burn skin.

Improper contact with components under any cover will cause serious injury. Only trained maintenance personnel should access compartments. Access by the operator is only advised when performing a pre-operation inspection. All compartments must remain closed and secured during operation.

### ⚠ Explosion and Fire Hazards

Do not operate the machine or charge the battery in hazardous locations or locations where potentially flammable or explosive gases or particles may be present.

## Work Area Safety

### ⚠ Damaged Machine Hazards

Do not use a damaged or malfunctioning machine.

Conduct a thorough pre-operation inspection of the machine and test all functions before each work shift. Immediately tag and remove from service a damaged or malfunctioning machine.

Be sure all maintenance has been performed as specified in this manual and the appropriate Genie service manual.

Be sure all decals are in place and legible.

Be sure the operator's, safety and responsibilities manuals are complete, legible and in the storage container located on the machine.

### ⚠ Component Damage Hazards

Do not use any battery charger greater than 48V to charge the batteries.

Do not use the machine as a ground for welding.

### ⚠ Battery Safety

#### Burn Hazards



Batteries contain acid. Always wear protective clothing and eye wear when working with batteries.

Avoid spilling or contacting battery acid. Neutralize battery acid spills with baking soda and water.

Do not expose the batteries or the charger to water or rain during charging.

#### Explosion Hazards

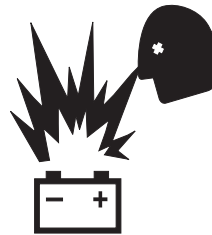

Keep sparks, flames and lighted tobacco away from batteries. Batteries emit explosive gas.

The battery tray should remain open during the entire charging cycle.



Do not contact the battery terminals or the cable clamps with tools that may cause sparks.





## Work Area Safety

### Component Damage Hazard

Do not use any battery charger greater than 48V to charge the batteries.

### Electrocution/Burn Hazards



Connect the battery charger to a grounded, AC 3-wire electrical outlet only.

Inspect daily for damaged cords, cables and wires. Replace damaged items before operating.

Avoid electrical shock from contact with battery terminals. Remove all rings, watches and other jewelry.

### Tip-over Hazard

Do not use batteries that weigh less than the original equipment. Batteries are used as counterweight and are critical to machine stability. For GS-4069 machine, each battery must weigh 39.9 kg. For each GS-2669 and GS-3369 machine with high capacity battery option, each battery must weigh 39.9 kg. For GS-2669 and GS-3369 machines with the standard battery option, each battery must weigh 28.1 kg.

### Lifting Hazard

Use the appropriate number of people and proper lifting techniques when lifting batteries.

### Lockout After Each Use

- 1 Select a safe parking location—firm level surface, clear of obstruction and traffic.
- 2 Retract and lower the boom to the stowed position.
- 3 Rotate the turntable so that the boom is between the non-steer wheels.
- 4 Turn the key switch to the off position and remove the key to secure from unauthorized use.

# Legend

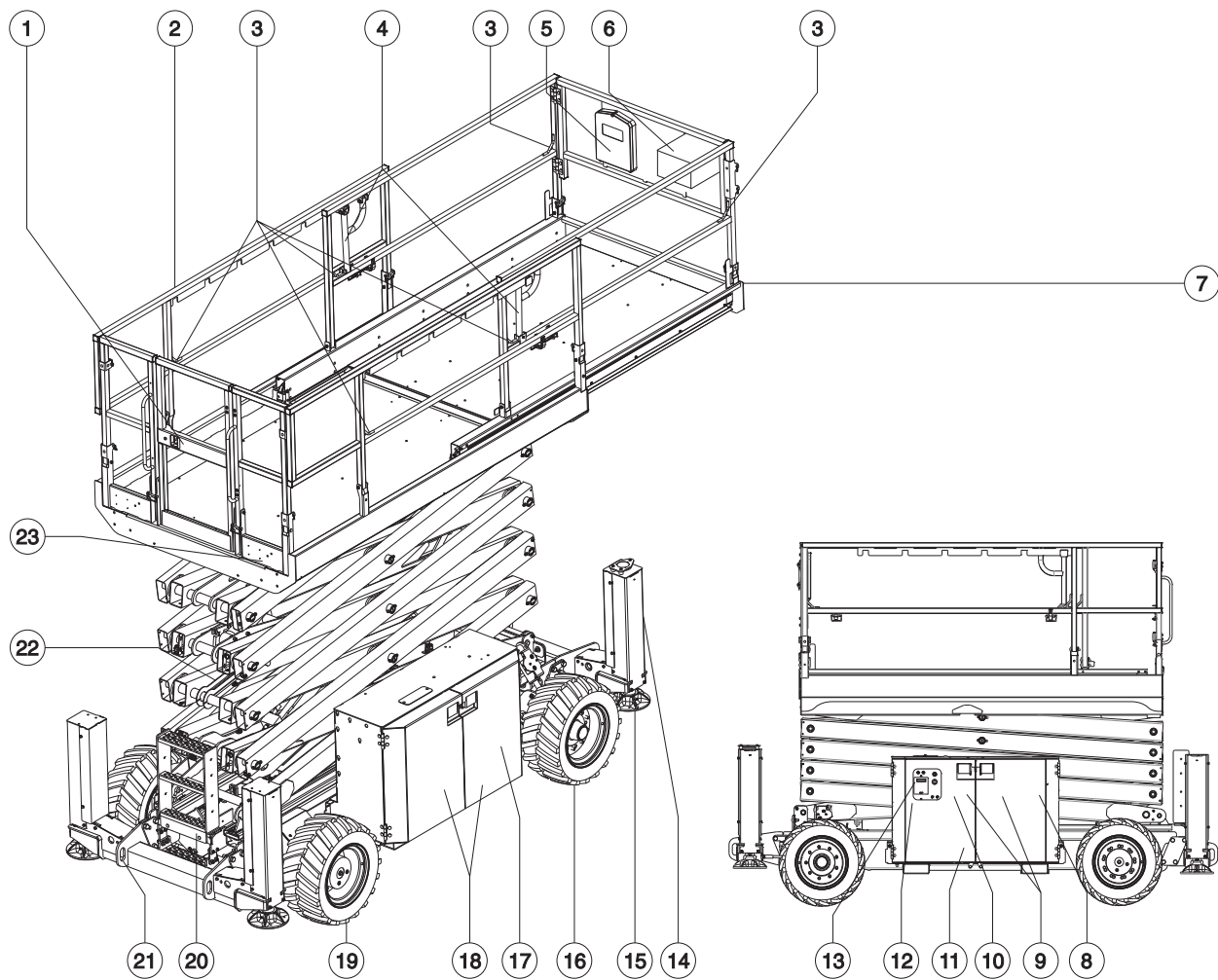

- |  |  |
|--|--|
| 1 Platform entry gate  | 12 Hydraulic oil level indicator (behind cover)    |
| 2 Platform guard rails                                       | 13 Ground controls with LCD readout screen         |
| 3 Lanyard anchorage points                                   | 14 Outrigger housing (if equipped with outriggers) |
| 4 Platform extension lock handle                             | 15 Outrigger footpad (if equipped with outriggers) |
| 5 Manual storage container                                   | 16 Steer tire                                      |
| 6 Platform controls  | 17 Inverter (optional)                             |
| 7 Platform extension   | 18 Battery compartment covers                      |
| 8 Battery charger (behind cover at the ground controls side) | 19 Non-steer tire                                  |
| 9 Ground controls side cover                                 | 20 Entry ladder                                    |
| 10 Hydraulic tank (behind cover)                             | 21 Transport tie-down                              |
| 11 Tilt alarm (behind cover)                                 | 22 Safety arm                                      |
|  | 23 GFCI outlet                                     |

# Controls

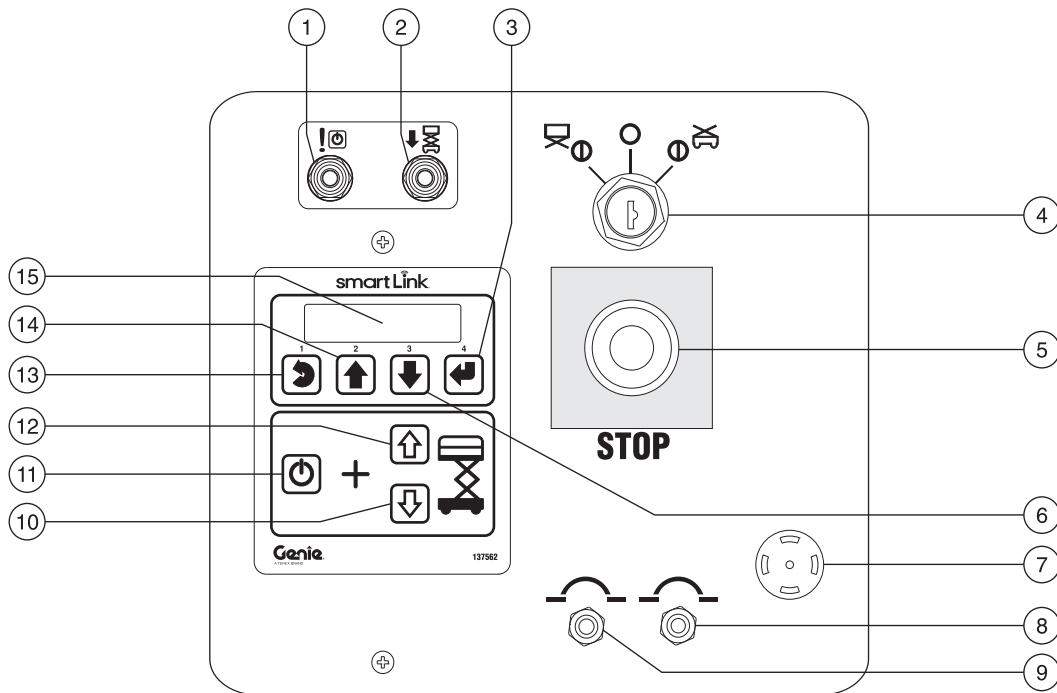

## Ground Control Panel

- |  |  |
|--|--|
| <p>1 Function enable toggle switch for emergency lowering.</p> <p>2 Emergency lowering toggle switch</p> <p>3 Menu enter button</p> <p>4 Key switch for platform/off/ground selection<br/>Turn the key switch to the platform position and the platform controls will operate. Turn the key switch to the off position and the machine will be off. Turn the key switch to the ground position and the ground controls will operate.</p> <p>5 Red Emergency Stop button<br/>Push in the red Emergency Stop button to the off position to stop all functions. Pull out the red Emergency Stop button to the on position to operate the machine.</p> | <p>6 Menu down button</p> <p>7 Alarm</p> <p>8 7A breaker for controls circuit</p> <p>9 15A breaker for controls circuit</p> <p>10 Platform down button</p> <p>11 Lift function enable button<br/>Press and hold this button to activate the lift function.</p> <p>12 Platform up button</p> <p>13 Menu escape button</p> <p>14 Menu up button</p> <p>15 LCD diagnostic readout</p> |
|--|--|

# Controls

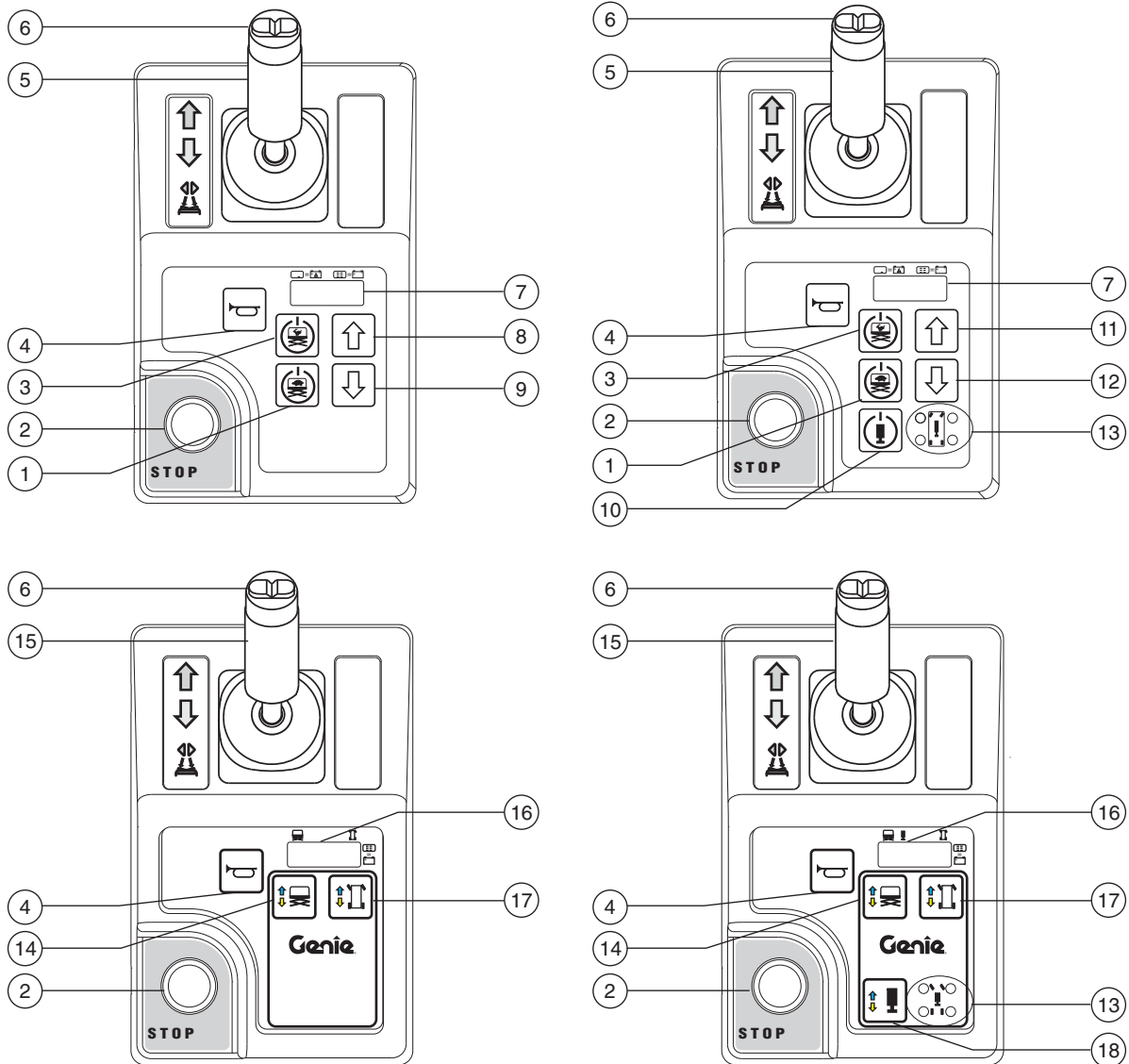

## Platform Control Panel

- 1 Low speed lift enable button

Press and hold this button to activate the low speed platform function.



- 2 Red Emergency Stop button

Push in the red Emergency Stop button to the off position to stop all functions. Pull out the red Emergency Stop button to the on position to operate the machine.

# Controls

3 High speed lift enable button

Press and hold this button to activate the high speed platform function.



4 Horn button

Press the horn button and the horn will sound. Release the horn button and the horn will not sound.



5 Proportional control handle and function enable switch for drive function

Drive function: Press and hold the function enable switch to enable the drive function on the platform control handle. Move the control handle in the direction indicated by the blue arrow on the control panel and the machine will move in the direction that the blue arrow points. Move the control handle in the direction indicated by the yellow arrow on the control panel and the machine will move in the direction that the yellow arrow points.

6 Thumb rocker switch for steer function

Press the left side of the thumb rocker and the machine will turn in the direction the blue triangle points on the platform control panel.



Press the right side of the thumb rocker and the machine will turn in the direction the yellow triangle points on the platform control panel.



7 LED diagnostic readout / battery charge indicator

8 Platform up button

Press and hold the platform up button and the platform will raise.



9 Platform down button

Press and hold the platform down button and the platform will lower.

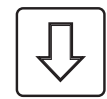

10 Outrigger enable button

Press and hold this button to activate the outrigger function.

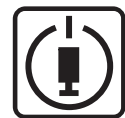

11 Platform up OR outrigger retract button

Press and hold this button and the platform will raise OR the outriggers will retract.



12 Platform down OR outrigger extend button

Press and hold this button and the platform will lower OR the outriggers will extend.



## Controls

### 13 Outrigger indicator lights

During outrigger extension, lights flash green. As each outrigger contacts the ground, lights turn solid green. Any time the outrigger extension procedure is interrupted, the lights will flash green indicating the outriggers are not contacting the ground or the outriggers are not fully deployed. During outrigger retraction lights turn solid green. As each outrigger fully retracts, lights turn off. Lights will turn solid red, indicating the corresponding outrigger is at end of stroke.

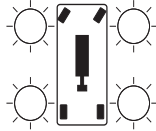

### 14 Lift function button

Push this button to activate the lift function.

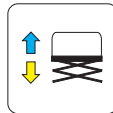

### 15 Proportional control handle and function enable switch for drive, steer, lift and outrigger functions

**Lift function:** Press and hold the function enable switch to enable the lift function on the platform control handle. Move the control handle in the direction indicated by the blue arrow and the platform will raise. Move the control handle in the direction indicated by the yellow arrow and the platform will lower. The descent alarm should sound while the platform is lowering.

**Drive function:** Press and hold the function enable switch to enable the drive function on the platform control handle. Move the control handle in the direction indicated by the blue arrow on the control panel and the machine will move in the direction that the blue arrow points. Move the control handle in the direction indicated by the yellow arrow on the control panel and the machine will move in the direction that the yellow arrow points.

**Outrigger function:** Press and hold the function enable switch to enable the outrigger function on the platform control handle. Move the control handle in the direction indicated by the blue arrow and the outriggers will retract. Move the control handle in the direction indicated by the yellow arrow and the outriggers will extend.

### 16 LED diagnostic readout, battery charge indicator and lift/drive mode indicator

### 17 Drive function button

Push this button to activate the drive function.

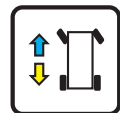

### 18 Outrigger function button

Press this button to activate the outrigger function.



# Inspections



---

## Do Not Operate Unless:

- You learn and practice the principles of safe machine operation contained in this operator's manual.
  - 1 Avoid hazardous situations.
  - 2 Always perform a pre-operation inspection.**
  - Know and understand the pre-operation inspection before going on to the next section.**
  - 3 Always perform function tests prior to use.
  - 4 Inspect the workplace.
  - 5 Only use the machine as it was intended.

## Pre-operation Inspection Fundamentals

It is the responsibility of the operator to perform a pre-operation inspection and routine maintenance.

The pre-operation inspection is a visual inspection performed by the operator prior to each work shift. The inspection is designed to discover if anything is apparently wrong with a machine before the operator performs the function tests.

The pre-operation inspection also serves to determine if routine maintenance procedures are required. Only routine maintenance items specified in this manual may be performed by the operator.

Refer to the list on the next page and check each of the items.

If damage or any unauthorized variation from factory delivered condition is discovered, the machine must be tagged and removed from service.

Repairs to the machine may only be made by a qualified service technician, according to the manufacturer's specifications. After repairs are completed, the operator must perform a pre-operation inspection again before going on to the function tests.

Scheduled maintenance inspections shall be performed by qualified service technicians, according to the manufacturer's specifications and the requirements listed in the responsibilities manual.

# Inspections

## Pre-operation Inspection

- Be sure that the operator's, safety and responsibilities manuals are complete, legible and in the storage container located in the platform.
- Be sure that all decals are legible and in place. See Inspections section.
- Check for hydraulic oil leaks and proper oil level. Add oil if needed. See Maintenance section.
- Check for battery fluid leaks and proper fluid level. Add distilled water if needed. See Maintenance section.

Check the following components or areas for damage, improperly installed or missing parts and unauthorized modifications:

- Electrical components, wiring and electrical cables
- Hydraulic hoses, fittings, cylinders and manifolds
- Drive motors
- Wear pads
- Tires and wheels
- Limit switches, alarms and horn
- Alarms and beacons (if equipped)
- Nuts, bolts and other fasteners
- Brake release components
- Safety arm
- Platform extension

- Scissor pins and retaining fasteners
- Lanyard anchorage points
- Platform control joystick
- Outrigger housing and footpads (if equipped)
- Battery pack and connections
- Ground strap
- Platform entry gate
- Inverter (if equipped)
- Outrigger housing and footpads (if equipped)

Check entire machine for:

- Cracks in welds or structural components
- Dents or damage to machine
- Excessive rust, corrosion or oxidation
- Be sure that all structural and other critical components are present and all associated fasteners and pins are in place and properly tightened.
- Be sure side rails are installed and bolts are fastened.

Note: If the platform must be raised to inspect the machine, make sure the safety arm is in place. See Operating Instructions section.



# Inspections



---

## Do Not Operate Unless:

- You learn and practice the principles of safe machine operation contained in this operator's manual.
  - 1 Avoid hazardous situations.
  - 2 Always perform a pre-operation inspection.
  - 3 Always perform function tests prior to use.**
- Know and understand the function tests before going on to the next section.**
  - 4 Inspect the workplace.
  - 5 Only use the machine as it was intended.

## Function Test Fundamentals

The function tests are designed to discover any malfunctions before the machine is put into service. The operator must follow the step-by-step instructions to test all machine functions.

A malfunctioning machine must never be used. If malfunctions are discovered, the machine must be tagged and removed from service. Repairs to the machine may only be made by a qualified service technician, according to the manufacturer's specifications.

After repairs are completed, the operator must perform a pre-operation inspection and function tests again before putting the machine into service.

# Inspections

## At the Ground Controls

- 1 Select a test area that is firm, level and free of obstruction.
  - 2 Be sure the batteries are connected.
  - 3 Pull out the platform and ground red Emergency Stop button to the on position.
  - 4 Turn the key switch to ground control.
  - 5 Observe the diagnostic LED readout on the platform controls.
- ⊙ Result: The LED should look like the picture below.



- 6 Observe the diagnostic LCD readout on the ground controls.
- ⊙ Result: The LCD should display the model and hour meter.

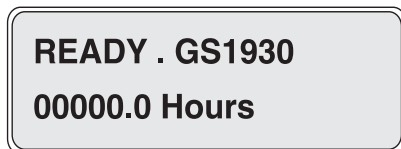

## Test Emergency Stop

- 7 Push in the ground red Emergency Stop button to the off position.
- ⊙ Result: No functions should operate.
- 8 Pull out the red Emergency Stop button to the on position.

## Test the Up/Down Functions

The audible warnings on this machine and the standard horn all come from the same central alarm. The horn is a constant tone. The descent alarm sounds at 60 beeps per minute. The alarm sounds at 180 beeps per minute when the machine is not level.

- 9 Do not press the lift function enable button.
  - 10 Press the platform up or platform down button.
- ⊙ Result: The lift function should not operate.
- 11 Do not press the platform up or platform down buttons.
  - 12 Press the lift function enable button.
- ⊙ Result: The lift function should not operate.
- 13 Press and hold the lift function enable button, and press the platform up button.
- ⊙ Result: The platform should raise.
- 14 Press and hold the lift function enable button, and press the platform down button.
- ⊙ Result: The platform should lower. The descent alarm should sound while the platform is lowering.

# Inspections

## Test Emergency Lowering

- 15 Activate the up function by pressing the lift enable button and platform up button, and raise the platform approximately 60 cm.
- 16 Push in the ground red Emergency Stop button to the off position.
- 17 Pull out the red Emergency Stop button to the on position.
- 18 Move and hold the emergency lowering function enable toggle switch.
- 19 Move and hold the emergency lowering toggle switch.
- ⊙ Result: The platform should lower. The descent alarm will not sound.
- 20 Turn the key switch to platform control.

## At the Platform Controls

### Test Emergency Stop

- 21 Push in the platform red Emergency Stop button to the off position.
- ⊙ Result: No functions should operate.

### Test the Horn

- 22 Pull out the red Emergency Stop button to the on position.
- 23 Press the horn button.
- ⊙ Result: The horn should sound.

## Use the button pattern on the platform controls to determine which of these next two function tests to perform.

Use this function test procedure if the decal on your platform controls has these buttons.



## Test the Function Enable Switch and the Up/Down Functions

- 24 Do not hold the function enable switch on the control handle.
- 25 Slowly move the control handle in the direction indicated by the blue arrow, then in the direction indicated by the yellow arrow.
- ⊙ Result: No functions should operate.
- 26 Do not press the high speed or low speed lift enable buttons.
- 27 Press the platform up or platform down button.
- ⊙ Result: The lift function should not operate.
- 28 Do not press the platform up or platform down buttons.
- 29 Press the high speed or low speed lift enable button.
- ⊙ Result: The lift function should not operate.
- 30 Press and hold the high speed lift enable button.
- 31 Press the platform up button.
- ⊙ Result: The platform should raise. The pothole guards should deploy.

## Inspections

- 32 Release the high speed lift enable button or the platform up button.
- ⦿ Result: The platform should stop raising.
- 33 Press and hold the high speed lift enable button.
- 34 Press the platform down button.
- ⦿ Result: The platform should lower. The descent alarm should sound while the platform is lowering.
- 35 Release the high speed lift enable button or the platform down button.
- ⦿ Result: The platform should stop lowering.
- 36 Press and hold the low speed lift enable button.
- 37 Press the platform up button.
- ⦿ Result: The platform should raise. The pothole guards should deploy.
- 38 Release the low speed lift enable button or the platform up button.
- ⦿ Result: The platform should stop raising.
- 39 Press and hold the low speed lift enable button.
- 40 Press the platform down button.
- ⦿ Result: The platform should lower at the same descent speed as high speed. The descent alarm should sound while the platform is lowering.
- 41 Release the low speed lift enable button or the platform down button.

Result: The platform should stop lowering.

Use this function test procedure if the decal on your platform controls has these buttons.



### Test the Function Enable Switch and the Up/Down Functions

- 42 Do not hold the function enable switch on the control handle.
- 43 Slowly move the control handle in the direction indicated by the blue arrow, then in the direction indicated by the yellow arrow.
- ⦿ Result: No functions should operate.
- 44 Press the lift function button.
- 45 Wait seven seconds for the lift function to time out.
- 46 Slowly move the control handle in the direction indicated by the blue arrow, then in the direction indicated by the yellow arrow.
- ⦿ Result: The lift function should not operate.
- 47 Press the lift function button.
- 48 Press and hold the function enable switch on the control handle. Slowly move the control handle in the direction indicated by the blue arrow.
- ⦿ Result: The platform should raise.
- 49 Release the control handle.
- ⦿ Result: The platform should stop raising.
- 50 Press and hold the function enable switch on the control handle. Slowly move the control handle in the direction indicated by the yellow arrow.
- ⦿ Result: The platform should lower. The descent alarm should sound while the platform is lowering.

# Inspections

## Test the Drive Function Button

Use this function test procedure if the decal on your platform controls has these buttons.



- 51 Press the drive function button (if equipped). 
  - 52 Wait seven seconds for the drive function to time out.
  - 53 Slowly move the control handle in the direction indicated by the blue arrow, then in the direction indicated by the yellow arrow.
- ⊙ Result: No functions should operate.

## Test the Steering

Note: When performing the steer and drive function tests, stand in the platform facing the steer end of the machine.

- 54 Press the drive function button (if equipped). 
  - 55 Press and hold the function enable switch on the control handle.
  - 56 Press the thumb rocker switch on top of the control handle in the direction indicated by the blue triangle on the control panel.
- ⊙ Result: The steer wheels should turn in the direction indicated by the blue triangle.
- 57 Press the thumb rocker switch on top of the control handle in the direction indicated by the yellow triangle, on the control panel.
- ⊙ Result: The steer wheels should turn in the direction indicated by the yellow triangle.

## Test Drive and Braking

- 58 Press the drive function button (if equipped). 
  - 59 Press and hold the function enable switch on the control handle.
  - 60 Slowly move the control handle in the direction indicated by the blue arrow on the control panel until the machine begins to move, then return the control handle to the center position.
- ⊙ Result: The machine should move in the direction that the blue arrow points on the control panel, then come to an abrupt stop when the control handle is returned to the center position.
- 61 Slowly move the control handle in the direction indicated by the yellow arrow on the control panel until the machine begins to move, then return the control handle to the center position.
- ⊙ Result: The machine should move in the direction that the yellow arrow points on the control panel, then come to an abrupt stop when the control handle is returned to the center position.

Note: The brakes must be able to hold the machine on any slope it is able to climb.

# Inspections

## Test the Tilt Sensor Operation

Note: Perform this test from the ground with the platform controller. Do not stand in the platform.

- 62 Fully lower the platform.
- 63 Place a 2x4 or similar piece of wood under both wheels on one side and drive the machine up onto them.
- 64 Raise the platform approximately 2.1 m from the ground.
- ⊙ Result: The platform should stop and the tilt alarm will sound at 180 beeps per minute. The platform controls LED readout should display LL and the ground controls LCD should display LL: Machine Tilted.

- 65 Press the drive function button (if equipped).



- 66 Press and hold the function enable switch on the control handle.
- 67 Move the control handle in the direction indicated by the blue arrow, then move the control handle in the direction indicated by the yellow arrow.
- ⊙ Result: The drive function should not work in either direction.
- 68 Lower the platform and remove both pieces of wood.

## Test Elevated Drive Speed

- 69 Raise the platform approximately 1.2 m from the ground.

- 70 Press the drive function button (if equipped).



- 71 Press and hold the function enable switch on the control handle. Slowly move the control handle to full drive position.

- ⊙ Result: The maximum achievable drive speed with the platform raised should not exceed 13 cm per second.

If the drive speed with the platform raised exceeds 13 cm per second, immediately tag and remove the machine from service.

# Inspections

## Test Stowed Drive Speed

- 72 Press and hold the lift function enable button, and press the platform down button.
- ⊙ Result: The platform should lower.
- 73 Press and hold the drive/steer function enable switch on the control handle. Slowly move the control handle to full drive position in the direction indicated by the blue arrow.
- ⊙ Result: The maximum achievable drive speed with the platform stowed should not exceed 2 m per second.
- 74 Press and hold the drive/steer function enable switch on the control handle. Slowly move the control handle to full drive position in the direction indicated by the yellow arrow.
- ⊙ Result: The maximum achievable drive speed with the platform stowed should not exceed 1.34 m per second.

If the drive speed in reverse with the platform stowed exceeds 1.34 m per second, immediately tag and remove the machine from service.

## Use the button pattern on the platform controls to determine which of these next two function tests to perform.

Use this function test procedure if the decal on your platform controls has these buttons.



## Test the Outrigger System (if equipped)

- 75 Press and hold the high speed lift enable button.
- 76 Press and hold the platform up button.
- ⊙ Result: The platform should raise. Raise the platform to approximately 2.4 m and stop.
- 77 Press and hold the outrigger enable button.
- ⊙ Result: The outriggers should not extend.
- 78 Press and hold the outrigger extend button.
- ⊙ Result: The outriggers should not extend.
- 79 Press and hold the outrigger enable button. Press the outrigger extend button.
- ⊙ Result: The outriggers should not extend.
- 80 Fully lower the platform.
- 81 Press and hold the outrigger enable button.
- ⊙ Result: The outriggers should not extend.

## Inspections

82 Press and hold the outrigger extend button.

- ⊙ Result: The outriggers should not extend.

83 Press and hold the outrigger enable button. Press the outrigger extend button.

- ⊙ Result: The outriggers should extend and level the machine. An alarm will sound when the machine is level. The outrigger indicator lights will be green.

Note: If an outrigger comes off the ground during leveling, the outrigger indicator light will turn red. The outriggers will have to be retracted until all outriggers are off the ground before leveling can be attempted again.

84 Press and hold the drive/steer function enable switch on the control handle.

85 Slowly move the control handle in the direction indicated by the blue arrow, then in the direction indicated by the yellow arrow.

- ⊙ Result: The machine should not move in the directions indicated by the blue and yellow arrows.

86 Press and hold the function enable switch on the control handle.

87 Press the thumb rocker switch on top of the control handle in the direction indicated by the blue and yellow triangles on the control panel.

- ⊙ Result: The steer wheels should not turn in the directions indicated by the blue and yellow triangles.

88 Press and hold the high speed lift enable button.

89 Press and hold the platform up button.

- ⊙ Result: The platform should raise. Raise the platform to approximately 2.4 m and stop.

90 Fully lower the platform.

91 Press and hold the outrigger enable button.

- ⊙ Result: The outriggers should not retract.

92 Press and hold the outrigger retract button.

- ⊙ Result: The outriggers should not retract.

93 Press and hold the outrigger enable button. Press the outrigger retract button.

- ⊙ Result: The outriggers should retract and return to the stowed position. The outrigger indicator lights will be off.



# Inspections

Use this function test procedure if the decal on your platform controls has these buttons.



## Test the Outrigger System (if equipped)

- 94 Press the outrigger function button. On the LCD screen, a circle below the outrigger function symbol will turn on.

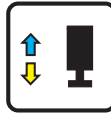

If the control handle is not moved within seven seconds of pushing the outrigger function button, the circle below the outrigger function symbol will turn off and outrigger function will not operate. Press the outrigger function button again.

- 95 Press and hold the function enable switch on the control handle.
- 96 Move the control handle in the direction indicated by the yellow arrow.
- ⊙ Result: The outriggers should extend. The individual outrigger indicator lights will flash green as the corresponding outrigger extends.
- 97 Continue holding the control handle in the direction indicated by the yellow arrow until all outrigger indicator lights turn solid green and a long beep is heard from the platform controls alarm. The machine is now level. At this point, the drive and steer functions are disabled.

Note: If the control handle is released too soon during extension, the outrigger indicator lights will continue to flash green, indicating the outriggers are not contacting the ground.

Note: If the control handle is released too soon after the outriggers have contacted the ground, a long beep will not be heard at the platform controls and the outrigger indicator lights will be solid green. If a long beep is not heard and the outrigger indicator lights are solid green, this condition may indicate the outriggers are not fully deployed or the machine is not level.

- 98 Press the drive function button.
- 99 Press and hold the function enable switch on the control handle.
- 100 Slowly move the control handle in the direction indicated by the blue arrow, then in the direction indicated by the yellow arrow.
- ⊙ Result: The machine should not move in the directions indicated by the blue and yellow arrows.
- 101 Press the drive function button.
- 102 Press and hold the function enable switch on the control handle.
- 103 Press the thumb rocker switch on top of the control handle in the direction indicated by the blue and yellow triangles on the control panel.
- ⊙ Result: The steer wheels should not turn in the directions indicated by the blue and yellow triangles.
- 104 Raise the platform.
- ⊙ Result: The platform should raise. Raise the platform to approximately 2.4 m and stop.

# Inspections

105 Fully lower the platform.

106 Press the outrigger function button.

107 Wait seven seconds for the outrigger function enable to time out.

108 Slowly move the control handle in the direction indicated by the blue arrow, then in the direction indicated by the yellow arrow.

⊙ Result: The outriggers should not retract.

109 Press the outrigger function button.

110 Move the control handle in the direction indicated by the blue arrow.

⊙ Result: The outriggers should retract. The individual outrigger indicator lights will turn solid green as the corresponding outrigger retracts.

111 Continue holding the control handle until the outriggers are completely retracted. Release the control handle when all outrigger indicator lights turn off. All functions are now restored.

Note: If the control handle is released too soon during retraction, the outrigger indicator lights will flash green, indicating the outriggers are not fully retracted.

## Test the Oscillate System

Note: Perform this test from the ground with the platform controller. Do not stand in the platform.

### Test the Oscillate System (stowed position)

112 Drive the left steer tire up onto a 10 cm high ramp.

⊙ Result: All four tires should maintain firm contact with the ground.

113 Drive the right steer tire up onto a 10 cm high ramp.

⊙ Result: All four tires should maintain firm contact with the ground.

Note: Verify that there are no fault codes shown on ground control display.

### Test the Oscillate System (elevated position)

114 Push and hold the lift function enable button and raise the platform approximately 213 cm to 274 cm.

115 Drive the left steer tire into a 10 cm deep hole.

⊙ Result: All four tires should maintain firm contact with the ground.

116 Drive the right steer tire into a 10 cm deep hole.

⊙ Result: All four tires should maintain firm contact with the ground.

Note: Verify that there are no fault codes shown on ground control display.

# Inspections



## Do Not Operate Unless:

- You learn and practice the principles of safe machine operation contained in this operator's manual.
  - 1 Avoid hazardous situations.
  - 2 Always perform a pre-operation inspection.
  - 3 Always perform function tests prior to use.
  - 4 Inspect the workplace.**

**Know and understand the workplace inspection before going on to the next section.**
  - 5 Only use the machine as it was intended.

## Workplace Inspection Fundamentals

The workplace inspection helps the operator determine if the workplace is suitable for safe machine operation. It should be performed by the operator prior to moving the machine to the workplace.

It is the operator's responsibility to read and remember the workplace hazards, then watch for and avoid them while moving, setting up and operating the machine.

## Workplace Inspection Checklist

Be aware of and avoid the following hazardous situations:

- drop-offs or holes
- bumps, floor obstructions or debris
- sloped surfaces
- unstable or slippery surfaces
- overhead obstructions and high voltage conductors
- hazardous locations
- inadequate surface support to withstand all load forces imposed by the machine
- wind and weather conditions
- the presence of unauthorized personnel
- other possible unsafe conditions

## Inspections

### Decals Inspection with Symbols

Determine whether the decals on your machine have words or symbols. Use the appropriate inspection to verify that all decals are legible and in place.

Below is a numerical list with quantities and descriptions.

Part No.	Decal Description	Qty
28174	Label – Power to Platform, 230V	3
28235	Label – Power to Platform, 115V	3
40434	Label – Lanyard Anchorage Point	6
43618	Label – Directional Arrows	1
43658	Label – Power to Charger, 230V	1
44980	Label – Power to Charger, 115V	1
44981	Label – Air Line to Platform	2
52475	Label – Transport Tie-down	4
72086	Label – Lifting Point	4
82473	Label – Compartment Access	2
82474	Label – Use Safety Chock	2
82475	Label – Crushing Hazard, Outriggers	4
82476	Label – Electrocution Hazard	2
82481	Label – Battery/Charger Safety	1
82487	Label – Read the Manual	2
82560	Label – Skin Injection Hazard	1
82562	Label – Crushing Hazard	4
82666	Label – Forklift Pocket	4
97719	Label – Safety Arm	1
114202	Label – Transport Diagram	2
114334	Label – Electrocution Hazard, Plug	2
114337	Label – Tip-over Hazard, Limit Switch	1
114338	Label – Tip-over Hazard, Tilt Alarm	1
114371	Label – Outrigger Safety	1
137605	Label – Emergency Stop, Platform Control	1

Part No.	Decal Description	Qty
137656	Label – Drive/Steer Direction, Platform Control	1
133537	Label – Crushing Hazard	1
229828	Warning – Hot Surface	2
230489	Label – Maximum Capacity, GS-2669RT	1
230490	Label – Maximum Capacity, GS-3369RT	1
230491	Label – Maximum Capacity, GS-4069RT	1
230805	Label – Manual Force, GS-2669RT	1
230806	Label – Manual Force, GS-3369RT	1
230807	Label – Manual Force, GS-4069RT	1
235163	Cosmetic – Genie GS-4069DC	2
236360	Overlay – Platform Control Panel (without outriggers)	1
236415	Overlay – Ground Control Panel	1
237122	Cosmetic – Genie GS-2669DC	2
237123	Cosmetic – Genie GS-3369DC	2
237124	Label – Wheel Load, GS-2669DC	4
237125	Label – Wheel Load, GS-3369DC	4
237126	Label – Wheel Load, GS-4069DC	4
237127	Overlay – Platform Control Panel (with outriggers)	1
237924	Label – Tip-over Hazard, Batteries, J305	1
237925	Label – Tip-over Hazard, Batteries, T105	1
237926	Label – Outrigger Load	4
1256708	Overlay – Platform Control Panel (without outriggers)	1
1256710	Overlay – Platform Control Panel (with outriggers)	1
1257923	Label – Smartlink	2

# Inspections

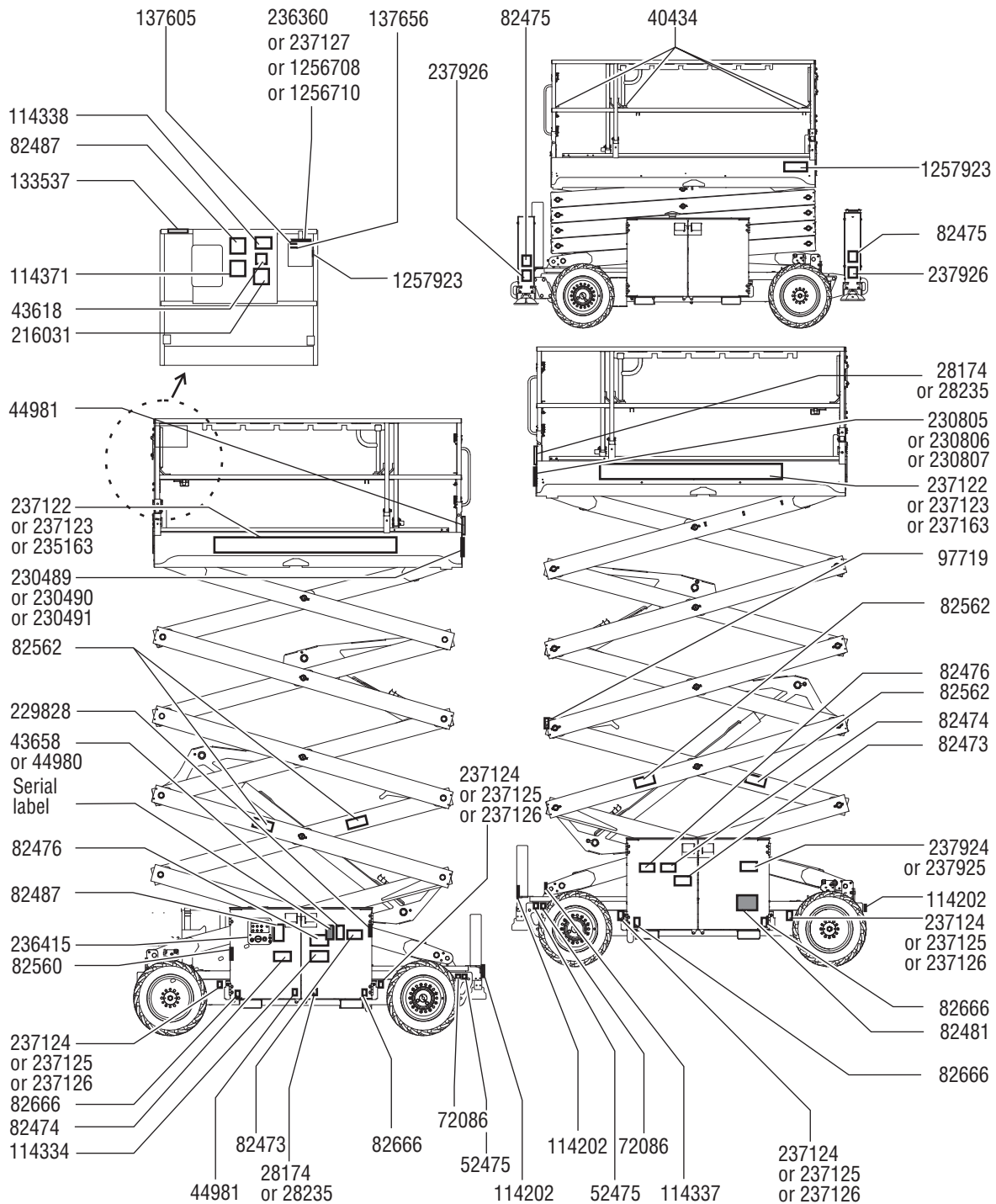

■ Shading indicates decal is hidden from view, i.e. under covers



---

# Operating Instructions



---

## Do Not Operate Unless:

- You learn and practice the principles of safe machine operation contained in this operator's manual.
  - 1 Avoid hazardous situations.
  - 2 Always perform a pre-operation inspection.
  - 3 Always perform function tests prior to use.
  - 4 Inspect the workplace.
  - 5 **Only use the machine as it was intended.**

## Fundamentals

The Operating Instructions section provides instructions for each aspect of machine operation. It is the operator's responsibility to follow all the safety rules and instructions in the operator's, safety and responsibilities manuals.

Using the machine for anything other than lifting personnel, along with their tools and materials, to an aerial work site is unsafe and dangerous.

Only trained and authorized personnel should be permitted to operate a machine. If more than one operator is expected to use a machine at different times in the same work shift, they must all be qualified operators and are all expected to follow all safety rules and instructions in the operator's, safety and responsibilities manuals. That means every new operator should perform a pre-operation inspection, function tests, and a workplace inspection before using the machine.

# Operating Instructions

## Emergency Stop

Push in the red Emergency Stop button to the off position at the ground controls or the platform controls to stop all functions.

Repair any function that operates when either red Emergency Stop button is pushed in.

## Emergency Lowering

- 1 Turn the key switch to ground control.
- 2 Pull out both ground and platform red Emergency Stop buttons to the on position.
- 3 Move and hold the emergency lowering function enable toggle switch.
- 4 Move and hold the emergency lowering toggle switch.

## Operation from Ground

- 1 Be sure the battery pack is connected before operating the machine.
- 2 Turn the key switch to ground control.
- 3 Pull out both ground and platform red Emergency Stop buttons to the on position.

### To Position Platform

- 1 At the control panel, press and hold the lift function enable button.
- 2 Press the platform up or down button.

Drive and steer functions are not available from the ground controls.

## Operation from Platform

- 1 Be sure the battery pack is connected before operating the machine.
- 2 Turn the key switch to platform control.
- 3 Pull out both ground and platform red Emergency Stop buttons to the on position.

### Controller Identification

These machines were produced with two different styles of platform controls. Use the button pattern on the platform controls to determine which instructions apply to your machine.

Use these instructions if the decal on your platform controls has these buttons.

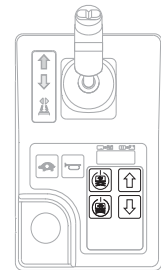

### To Position Platform

- 1 Press and hold the high or low speed lift enable button.
- 2 Press the platform up or platform down button.

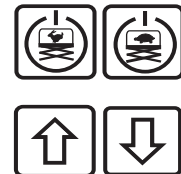

# Operating Instructions

## To Extend Outriggers

- 1 Press and hold the outrigger enable button.



- 2 Press and hold the outrigger extend button.

The outriggers will extend. Lower the outriggers until all outrigger indicator lights turn green and an alarm sounds. The machine is now level.

**Note:** If an outrigger comes off the ground during leveling, the outrigger indicator light will turn red. The outriggers will have to be retracted until all outriggers are off the ground before leveling can be attempted again.

**Note:** Drive function is disabled while the outriggers are extended.

## To Retract Outriggers

- 1 Press and hold the outrigger enable button.



- 2 Press and hold the outrigger retract button.

The outriggers will retract. The outrigger indicator lights will turn off as the corresponding outrigger retracts. Machine functions are restored once the outrigger are off the ground.

**Note:** Drive function is disabled while the outriggers are down.

## To Steer

- 1 Press and hold the drive/steer function enable switch on the control handle.

- 2 Turn the steer wheels with the thumb rocker switch located on the top of the control handle.



## To Drive

- 1 Press and hold the drive/steer function enable switch on the control handle.
- 2 Increase speed: Slowly move the control handle off center.

Decrease speed: Slowly move the control handle toward center.

Stop: Return the control handle to center or release the function enable switch.

Use the color-coded direction arrows on the platform controls and on the platform to identify the direction the machine will travel.

Machine travel speed is restricted when the platform is raised or in reverse.

Battery condition will affect machine performance. Machine drive speed and function speed will drop when the battery level indicator is flashing.



# Operating Instructions

## Controller Identification

Use these instructions if the decal on your platform controls has these buttons.

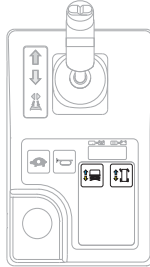

## To Position Platform

- 1 Press the lift function button. On the LCD screen, a circle below the lift function symbol will turn on.



If the control handle is not moved within seven seconds of pushing the lift function button, the circle below the lift function symbol will turn off and lift function will not operate. Press the lift function button again.

- 2 Press and hold the function enable switch on the control handle.
- 3 Move the control handle according to the markings on the control panel.

## To Extend Outriggers

To Extend Outriggers:

- 1 Press the outrigger function button. On the LCD screen, a circle below the outrigger function symbol will turn on.
- 2 Press and hold the function enable switch on the control handle.
- 3 Move the control handle in the direction indicated by the yellow arrow.

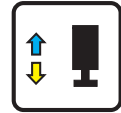

The outriggers will begin to extend. The individual outrigger indicator light will turn solid green as the corresponding outrigger makes contact with the ground. Continue moving the control handle until the lift enable indicator light turns green and a beep is heard. The machine is now level. When the lift error indicator light turns red, the up/down and drive functions are disabled. The lift error indicator light will turn red under the following conditions:

- Not all outriggers are in contact with the ground.
- All four outriggers are in contact with the ground but the machine is not level.
- Error code.

Note: If the outrigger enable and extend buttons are released too soon during extension, the outrigger indicator lights will continue to flash green, indicating the outriggers are not contacting the ground.

Note: If the outrigger lights are solid green, the machine may not be level or the outriggers may not be fully deployed if a long beep is not heard at the platform controls alarm.

# Operating Instructions

## To Retract Outriggers

To Retract Outriggers:

- 1 Press the outrigger function button.
- 2 Press and hold the function enable switch on the control handle.
- 3 Move the control handle in the direction indicated by the blue arrow.

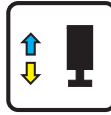

Release the control handle once the outriggers are off the ground. After approximately 5 seconds, the outrigger indicator lights will turn off. All functions are now restored.

**Note:** If the outrigger enable and retract buttons are released too soon during retraction, the outrigger indicator lights will flash green, indicating the outriggers are not fully retracted.

## To Steer

- 1 Press the drive function button. On the LCD screen, a circle below the drive function symbol will turn on.

If the control handle is not moved within seven seconds of pushing the drive function button, the circle below the drive function symbol will turn off and drive function will not operate. Press the drive function button again.

- 2 Turn the steer wheels with the thumb rocker switch located on the top of the control handle.



## To Drive

- 1 Press the drive function button. On the LCD screen, a circle below the drive function symbol will turn on.

If the control handle is not moved within seven seconds of pushing the drive function button, the circle below the drive function symbol will turn off and drive function will not operate. Press the drive function button again.

- 2 Press and hold the function enable switch on the control handle.

- 3 Increase speed: Slowly move the control handle off center.

Decrease speed: Slowly move the control handle toward center.

Stop: Return the control handle to center or release the function enable switch.

Use the color-coded direction arrows on the platform controls and on the platform to identify the direction the machine will travel.

Machine travel speed is restricted when the platform is raised.

Battery condition will affect machine performance. Machine drive speed and function speed will drop when the battery level indicator is flashing.

## Operating Instructions

### ▲ Driving on a slope

Determine the uphill, downhill and side slope ratings for the machine and determine the slope grade.



Maximum slope rating, extension deck uphill (gradeability): 35% (19°)



Maximum slope rating, extension deck downhill: 15% (9°)



Maximum side slope rating: 35% (19°)

Note: Slope rating is subject to ground conditions and adequate traction.

### To determine the slope grade:

Measure the slope with a digital inclinometer OR use the following procedure.

You will need:

- carpenter's level
- straight piece of wood, at least 1 m long
- tape measure

Lay the piece of wood on the slope.

At the downhill end, lay the level on the top edge of the piece of wood and lift the end until the piece of wood is level.

While holding the piece of wood level, measure the vertical distance from the bottom of the piece of wood to the ground.

Divide the tape measure distance (rise) by the length of the piece of wood (run) and multiply by 100.

Example:



Piece of wood = 3.6 m

Run = 3.6 m

Rise = 0.3 m

$0.3 \text{ m} \div 3.6 \text{ m} = 0.083 \times 100 = 8.3\% \text{ grade}$

If the slope exceeds the maximum uphill, downhill or side slope rating, then the machine must be winched or transported up or down the slope. See Transport and Lifting section.

# Operating Instructions

## Platform Overload

If the platform controls LED diagnostic readout displays a flashing OL and the ground controls LCD diagnostic readout displays OL: Platform Overloaded, the platform is overloaded and no functions will operate. An alarm will sound.

- 1 Push in the Red Emergency stop button to the off position.
- 2 Remove weight from the platform.
- 3 Pull out the Red Emergency Stop button to the on position.

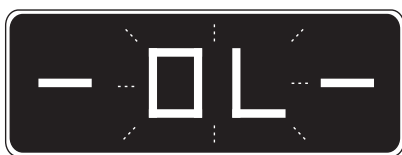

LED Readout



LCD Readout

## Overload Recovery

If the ground controls LCD diagnostic readout displays Overload Recovery, the emergency lowering system has been used while the platform was overloaded. For information on how to reset this message, please consult the appropriate Genie Service Manual.

## Operational indicator codes

If the platform controls LED or ground controls LCD diagnostic readout displays an operational indicator code such as LL, the fault condition must be repaired or removed before resuming machine operation. Push in and pull out the red Emergency Stop button to reset the system.



LED Readout

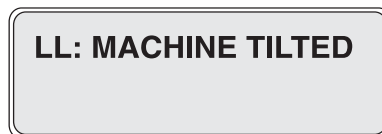

LCD Readout

### Operational Indicator Codes

Code	Condition
LL	Off-Level
OL	Platform Overloaded
CH	Chassis Mode Operation
Nd	No Drive (option)
Ld	Lifting Disabled
F053	DCON RR Thermal Protection
F054	DCON LR Thermal Protection
F055	Traction Motor RR Fault: Motor Temp
F056	Traction Motor LR Fault: Motor Temp

For further information, please consult the appropriate Genie Service Manual. A code and a description of a code can also be viewed at the ground controls LCD display.

## Operating Instructions

### To reset thermal limit cutout

If the platform controls LED readout displays fault codes F053, F054, F055 or F056, the machine has overheated. The fault condition must be repaired or removed before resuming machine operation.

- 1 Push in the red Emergency Stop button to the off position.
- 2 Allow the machine to cool for approximately 5 minutes before resuming machine operation.
- 3 Pull out the red Emergency Stop button to the on position.

### Operation from Ground with Controller

Maintain safe distances between the operator, machine and fixed objects.

Be aware of the direction the machine will travel when using the controller.

### Battery Level Indicator

Use the LED diagnostic readout to determine the battery level.

Note: When a blinking LO code appears on the platform controls LED display, the machine must be taken out of service and charged, otherwise all machine functions will be disabled.



Full Charge



Half Charge



Low Charge



LO Flashing

---

# Operating Instructions

## How to Use the Safety Arm

- 1 Raise the platform approximately 2.4 m from the ground.
- 2 Rotate the safety arm away from the machine and let it hang down.
- 3 Lower the platform until the safety arm rests securely on the link. Keep clear of the safety arm when lowering the platform.

## After Each Use

- 1 Select a safe parking location—firm level surface, clear of obstruction and traffic.
- 2 Lower the platform.
- 3 Turn the key switch to the off position and remove the key to secure from unauthorized use.
- 4 Charge the batteries.

## To Extend and Retract Platform

- 1 Lift the platform extension lock handles to the horizontal position.
- 2 Push the platform extension lock handles to extend the platform to the desired position.

Do not stand on the platform extension while trying to extend it.

- 3 Lower the platform extension lock handles and make sure the extension deck is locked.

# Operating Instructions



## Battery and Charger Instructions

### Observe and Obey:

- Do not use an external charger or booster battery.
- Charge the battery in a well-ventilated area.
- Use proper AC input voltage for charging as indicated on the charger.
- Use only a Genie authorized battery and charger.

### To Charge Battery

- 1 Be sure the batteries are connected before charging the batteries.
- 2 Open the battery compartment. The compartment should remain open for the entire charging cycle.

### Maintenance-free batteries

- 1 Connect the battery charger to a grounded AC circuit.
- 2 The charger will indicate when the battery is fully charged.

### Standard Batteries

- 1 Remove the battery vent caps and check the battery acid level. If necessary, add only enough distilled water to cover the plates. Do not overfill prior to the charge cycle.
- 2 Replace the battery vent caps.
- 3 Connect the battery charger to a grounded AC circuit.
- 4 The charger will indicate when the battery is fully charged.
- 5 Check the battery acid level when the charging cycle is complete. Replenish with distilled water to the bottom of the fill tube. Do not overfill.

---

# Operating Instructions

## Dry Battery Filling and Charging Instructions

- 1 Remove the battery vent caps and permanently remove the plastic seal from the battery vent openings.
- 2 Fill each cell with battery acid (electrolyte) until the level is sufficient to cover the plates.

Do not fill to maximum level until the battery charge cycle is complete. Overfilling can cause the battery acid to overflow during charging. Neutralize battery acid spills with baking soda and water.

- 3 Install the battery vent caps.
- 4 Charge the battery.
- 5 Check the battery acid level when the charging cycle is complete. Replenish with distilled water to the bottom of the fill tube. Do not overfill.



## Transport and Lifting Instructions



### Observe and Obey:

- ☑ Genie provides this securement information as a recommendation. Drivers are solely responsible for making sure machines are properly secured and the correct trailer is selected pursuant to US Department of Transportation regulations, other localized regulations, and their company policy.
- ☑ Genie customers needing to containerize any lift or Genie product should source a qualified freight forwarder with expertise in preparing, loading and securing construction and lifting equipment for international shipment.
- ☑ Only qualified aerial lift operators should move the machine on or off the truck.
- ☑ The transport vehicle must be parked on a level surface.
- ☑ The transport vehicle must be secured to prevent rolling while the machine is being loaded.
- ☑ Be sure the vehicle capacity, loading surfaces and chains or straps are sufficient to withstand the machine weight. Genie lifts are very heavy relative to their size. See the serial label for the machine weight.
- ☑ The machine must be on a level surface or secured before releasing the brakes.

- ☑ Do not drive the machine on a slope that exceeds the uphill, downhill or side slope rating. See Driving on a Slope in the Operating Instructions section.
- ☑ If the slope of the transport vehicle bed exceeds the maximum slope rating, the machine must be loaded and unloaded using a winch as described in the brake release operation.

### Free-wheel Configuration for Winching

Chock the wheels to prevent the machine from rolling.

All models: Release the wheel brakes by turning over the two rear torque hub disconnect caps.

Be sure the winch line is properly secured to the drive chassis tie points and the path is clear of all obstructions.

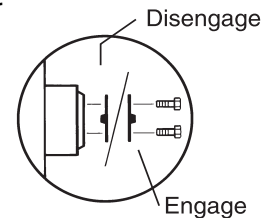

Reverse the procedures described to re-engage the brakes.

Chock the wheels to prevent the machine from rolling.

## Transport and Lifting Instructions

### Securing to Truck or Trailer for Transit

Always chock the machine wheels in preparation for transport.

Retract and secure the extension deck.

Use the tie-down points on the chassis for anchoring down to the transport surface.

Use a minimum of 2 chains or straps.

Use chains or straps of ample load capacity.

Turn the key switch to the off position and remove the key before transporting.

Inspect the entire machine for loose or unsecured items.

If the railings have been folded down, secure them with straps before transporting.

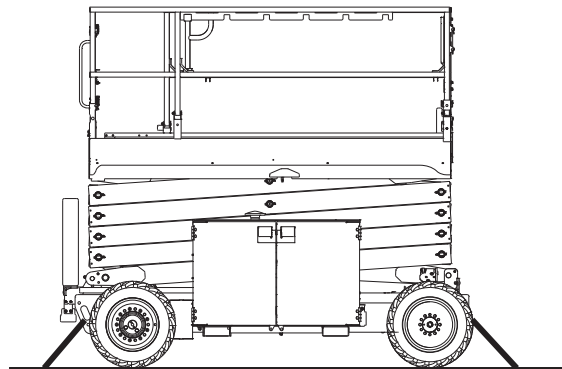
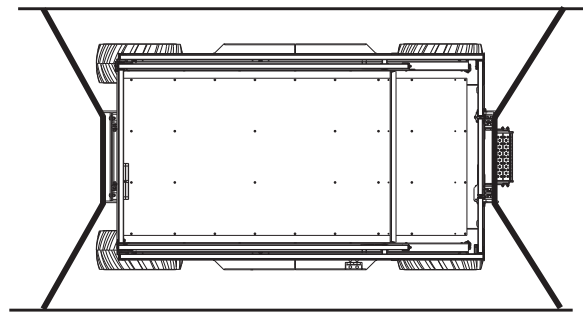

# Transport and Lifting Instructions



## Observe and Obey:

- ☑ Only qualified riggers should rig and lift the machine.
- ☑ Be sure the crane capacity, loading surfaces and straps or lines are sufficient to withstand the machine weight. See the serial label for the machine weight.

## Lifting Instructions

Fully lower the platform. Be sure the extension deck, controls and component trays are secure. Remove all loose items on the machine.

Determine the center of gravity of your machine using the table and the picture on this page.

Attach the rigging only to the designated lifting points on the machine.

Adjust the rigging to prevent damage to the machine and to keep the machine level.

Center of gravity	X Axis	Y Axis
GS-2669DC	97.3 cm	76 cm
GS-3369DC	106.9 cm	80 cm
GS-4069DC	99.6 cm	78 cm

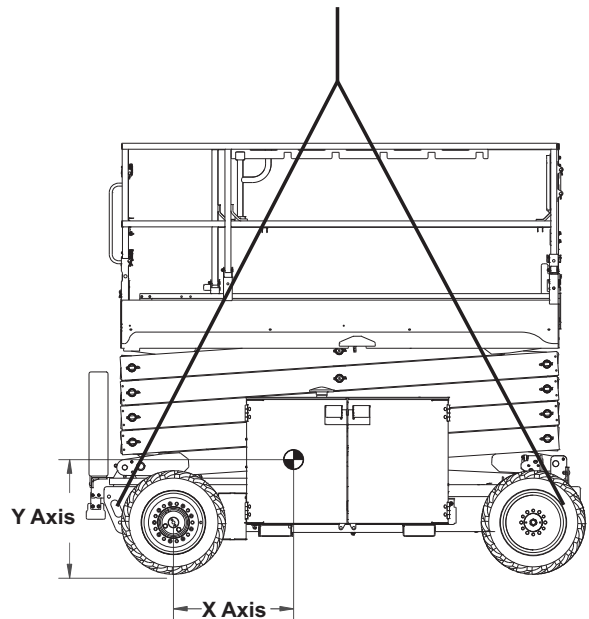

# Maintenance



## Observe and Obey:

- ☑ Only routine maintenance items specified in this manual shall be performed by the operator.
- ☑ Scheduled maintenance inspections shall be completed by qualified service technicians, according to the manufacturer's specifications and the requirements specified in the responsibilities manual.
- ☑ Dispose of material in accordance with governmental regulations.
- ☑ Use only Genie approved replacement parts.

## Maintenance Symbols Legend

The following symbols have been used in this manual to help communicate the intent of the instructions. When one or more of the symbols appear at the beginning of a maintenance procedure, it conveys the meaning below.



Indicates that tools will be required to perform this procedure.



Indicates that new parts will be required to perform this procedure.

## Check the Hydraulic Oil Level



Maintaining the hydraulic oil at the proper level is essential to machine operation. Improper hydraulic oil levels can damage hydraulic components. Daily checks allow the inspector to identify changes in oil level that might indicate the presence of hydraulic system problems.

- 1 Be sure that the platform is in the stowed position.
- 2 Visually inspect the sight gauge located on the side of the hydraulic oil tank.
- ⊙ Result: The hydraulic oil level should be within the top 5 cm of the sight gauge.
- 3 Add oil as needed. Do not overfill.

---

### Hydraulic oil specifications

---

Hydraulic oil type	Chevron Rando HD equivalent
--------------------	-----------------------------

---

# Maintenance

## Check the Batteries



Proper battery condition is essential to good machine performance and operational safety. Improper fluid levels or damaged cables and connections can result in component damage and hazardous conditions.

Note: This procedure does not need to be performed on machines with sealed or maintenance-free batteries.

- ▲ **Electrocution hazard.** Contact with hot or live circuits may result in death or serious injury. Remove all rings, watches and other jewelry.
- ▲ **Bodily injury hazard.** Batteries contain acid. Avoid spilling or contacting battery acid. Neutralize battery acid spills with baking soda and water.

Note: Perform this test after fully charging the batteries.

- 1 Put on protective clothing and eye wear.
- 2 Be sure that the battery cable connections are tight and free of corrosion.
- 3 Be sure that the battery hold-down brackets are in place and secure.

Note: Adding terminal protectors and a corrosion preventative sealant will help eliminate the corrosion on the battery terminals and cables.

## Scheduled Maintenance

Maintenance performed quarterly, annually and every two years must be completed by a person trained and qualified to perform maintenance on this machine according to the procedures found in the service manual for this machine.

Machines that have been out of service for more than three months must receive the quarterly inspection before they are put back into service.

# Specifications

<b>GS-2669DC</b>	
Height, working maximum	9.8 m
Height, platform maximum	8 m
Height, stowed maximum, rails up	2.59 m
Height, stowed maximum, rails lowered	1.92 m
Height, guard rails	1.47 m
Width	1.75 m
Length, platform retracted	3.12 m
Length, platform retracted, models with outriggers	3.76 m
Length, platform extended	4.51 m
Length, platform extended, models with outriggers	4.81 m
Length, outside platform extended	4.32 m
Maximum load capacity	680 kg
Maximum wind speed	Indoor 0 m/s Outdoor 12.5 m/s
Wheelbase	2.29 m
Turning radius (outside)	4.6 m
Turning radius (inside)	2.11 m
Ground clearance	24 cm
Power source, T105	8 batteries, 6V 225AH
Power source, J305	8 batteries, 6V 315AH
System voltage	48V
<b>Weight</b>	3,597 kg
(Machine weights vary with option configurations. See serial label for specific machine weight.)	
AC outlet in platform	Standard
<b>Platform dimensions</b>	
Platform length x width	2.79 x 1.6 m
Platform extension length	4.32 m
<b>Drive speeds</b>	
Stowed maximum, forward	7.2 km/h 12 m/6 sec
Stowed maximum, reverse	4.8 km/h 12 m/9 sec
Platform raised, maximum	0.5 km/h 12.2 m/90 sec
Maximum hydraulic pressure (functions)	241 bar
Tire size	26 x 12 x 380

## Airborne noise emissions

Sound pressure level at ground workstation <70 dBA

Sound pressure level at platform workstation <70 dBA

Total vibration value to which the hand/arm system is subjected does not exceed 2.5 m/s<sup>2</sup>.

Highest root mean square value of weighted acceleration to which the whole body is subjected does not exceed 0.5 m/s<sup>2</sup>.

## Maximum slope rating, stowed position

Extension deck uphill 35% (19°)

Extension deck downhill 15% (9°)

Side slope 35% (19°)

Note: Slope rating is subject to ground conditions and adequate traction.

## Floor loading information

Tire load maximum 1538 kg

Outrigger load, maximum 1465 kg

Tire contact pressure 5.97 kg/cm<sup>2</sup>  
584 kPa

Outrigger contact pressure 2.89 kg/cm<sup>2</sup>  
284 kPa

Occupied floor pressure 916 kg/m<sup>2</sup>  
8.98 kPa

Note: Floor loading information is approximate and does not incorporate different option configurations. It should be used only with adequate safety factors.

## Operating temperature

For ambient temperatures consistently **below** -17°C - use Chevron Aviation A Arctic hydraulic fluid or equivalent.

For ambient temperatures consistently **above** -17°C - use Chevron Rando HD MV hydraulic fluid or equivalent.

For operating temperatures consistently above 96°C - use Shell Tellus S2 V 46.

Continuous improvement of our products is a Genie policy. Product specifications are subject to change without notice or obligation.

# Specifications

## GS-3369DC

Height, working maximum	11.9 m
Height, platform maximum	10 m
Height, stowed maximum, rails up	2.59 m
Height, stowed maximum, rails lowered	1.92 m
Height, guard rails	1.47 m
Width	1.75 m
Length, platform retracted	3.12 m
Length, platform retracted, models with outriggers	3.76 m
Length, platform extended	4.51 m
Length, platform extended, models with outriggers	4.81 m
Length, outside platform extended	4.32 m
Maximum load capacity	454 kg
Maximum wind speed	Indoor 0 m/s Outdoor 12.5 m/s
Wheelbase	2.29 m
Turning radius (outside)	4.6 m
Turning radius (inside)	2.11 m
Ground clearance	24 cm
Power source, T105	8 batteries, 6V 225AH
Power source, J305	8 batteries, 6V 315AH
System voltage	48V
<b>Weight</b>	3,475 kg
(Machine weights vary with option configurations. See serial label for specific machine weight.)	
AC outlet in platform	Standard
<b>Platform dimensions</b>	
Platform length x width	2.79 x 1.6 m
Platform extension length	4.32 m
<b>Drive speeds</b>	
Stowed maximum, forward	7.2 km/h 12 m/6 sec
Stowed maximum, reverse	4.8 km/h 12 m/9 sec
Platform raised, maximum	0.5 km/h 12.2 m/90 sec
Maximum hydraulic pressure (functions)	241 bar
Tire size	26 x 12 x 380

## Airborne noise emissions

Sound pressure level at ground workstation	<70 dBA
Sound pressure level at platform workstation	<70 dBA
Total vibration value to which the hand/arm system is subjected does not exceed 2.5 m/s <sup>2</sup> .	

Highest root mean square value of weighted acceleration to which the whole body is subjected does not exceed 0.5 m/s<sup>2</sup>.

## Maximum slope rating, stowed position

Extension deck uphill	35% (19°)
Extension deck downhill	15% (9°)
Side slope	35% (19°)

Note: Slope rating is subject to ground conditions and adequate traction.

## Floor loading information

Tire load maximum	1478 kg
Outrigger load, maximum	1581 kg
Tire contact pressure	5.73 kg/cm <sup>2</sup> 562 kPa
Outrigger contact pressure	2.89 kg/cm <sup>2</sup> 284 kPa
Occupied floor pressure	684 kg/m <sup>2</sup> 6.71 kPa

Note: Floor loading information is approximate and does not incorporate different option configurations. It should be used only with adequate safety factors.

## Operating temperature

For ambient temperatures consistently **below** -17°C - use Chevron Aviation A Arctic hydraulic fluid or equivalent.

For ambient temperatures consistently **above** -17°C - use Chevron Rando HD MV hydraulic fluid or equivalent.

For operating temperatures consistently above 96°C - use Shell Tellus S2 V 46.

Continuous improvement of our products is a Genie policy. Product specifications are subject to change without notice or obligation.

# Specifications

## GS-4069DC

Height, working maximum	14 m
Height, platform maximum	12.3 m
Height, stowed maximum, rails up	2.74 m
Height, stowed maximum, rails lowered	2.08 m
Height, guard rails	1.65 m
Width	1.75 m
Length, platform retracted	3.12 m
Length, platform retracted, models with outriggers	3.76 m
Length, platform extended	4.51 m
Length, platform extended, models with outriggers	4.81 m
Length, outside platform extended	4.32 m
Maximum load capacity	363 kg
Maximum wind speed	Indoor 0 m/s Outdoor 12.5 m/s
Wheelbase	2.29 m
Turning radius (outside)	4.6 m
Turning radius (inside)	2.11 m
Ground clearance	24 cm
Power source, J305	8 batteries, 6V 315AH
System voltage	48V
<b>Weight</b>	4,958 kg
(Machine weights vary with option configurations. See serial label for specific machine weight.)	
AC outlet in platform	Standard
<b>Platform dimensions</b>	
Platform length x width	2.79 x 1.6 m
Platform extension length	4.32 m
<b>Drive speeds</b>	
Stowed maximum, forward	7.2 km/h 12 m/6 sec
Stowed maximum, reverse	4.8 km/h 12 m/9 sec
Platform raised, maximum	0.5 km/h 12.2 m/90 sec
Maximum hydraulic pressure (functions)	241 bar
Tire size	26 x 12 x 380

## Airborne noise emissions

Sound pressure level at ground workstation	<70 dBA
Sound pressure level at platform workstation	<70 dBA
Total vibration value to which the hand/arm system is subjected does not exceed 2.5 m/s <sup>2</sup> .	
Highest root mean square value of weighted acceleration to which the whole body is subjected does not exceed 0.5 m/s <sup>2</sup> .	

## Maximum slope rating, stowed position

Extension deck uphill	35% (19°)
Extension deck downhill	15% (9°)
Side slope	35% (19°)

Note: Slope rating is subject to ground conditions and adequate traction.

## Floor loading information

Tire load maximum	1749 kg
Outrigger load, maximum	1724 kg
Tire contact pressure	6.60 kg/cm <sup>2</sup> 647 kPa
Outrigger contact pressure	3.41 kg/cm <sup>2</sup> 334 kPa
Occupied floor pressure	1111 kg/m <sup>2</sup> 10.90 kPa

Note: Floor loading information is approximate and does not incorporate different option configurations. It should be used only with adequate safety factors.

## Operating temperature

For ambient temperatures consistently **below** -17°C - use Chevron Aviation A Arctic hydraulic fluid or equivalent.

For ambient temperatures consistently **above** -17°C - use Chevron Rando HD MV hydraulic fluid or equivalent.

For operating temperatures consistently above 96°C - use Shell Tellus S2 V 46.

Continuous improvement of our products is a Genie policy. Product specifications are subject to change without notice or obligation.



[www.genielift.com](http://www.genielift.com)

Distributed By: