



OM-2226

189783AL

2010-04

Processes



TIG (GTAW) Welding



Stick (SMAW) Welding

Description



115/230/400/460 Volt Models W/Autoline®
Arc Welding Power Source

Maxstar[®] 200 SD, DX, And LX (Including Optional Cart And Cooler) CE And Non-CE Models

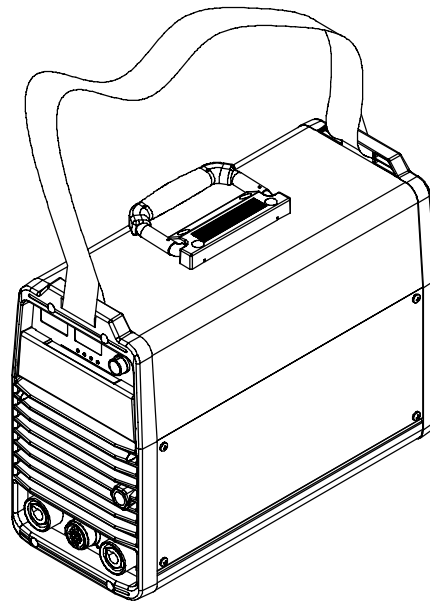

Visit our website at
www.MillerWelds.com

OWNER'S MANUAL

From Miller to You

Thank you and congratulations on choosing Miller. Now you can get the job done and get it done right. We know you don't have time to do it any other way.

That's why when Niels Miller first started building arc welders in 1929, he made sure his products offered long-lasting value and superior quality. Like you, his customers couldn't afford anything less. Miller products had to be more than the best they could be. They had to be the best you could buy.

Today, the people that build and sell Miller products continue the tradition. They're just as committed to providing equipment and service that meets the high standards of quality and value established in 1929.

This Owner's Manual is designed to help you get the most out of your Miller products. Please take time to read the Safety precautions. They will help you protect yourself against potential hazards on the worksite.

We've made installation and operation quick and easy. With Miller you can count on years of reliable service with proper maintenance. And if for some reason the unit needs repair, there's a Troubleshooting section that will help you figure out what the problem is. The parts list will then help you to decide the exact part you may need to fix the problem. Warranty and service information for your particular model are also provided.



Miller is the first welding equipment manufacturer in the U.S.A. to be registered to the ISO 9001:2000 Quality System Standard.

Miller Electric manufactures a full line of welders and welding related equipment. For information on other quality Miller products, contact your local Miller distributor to receive the latest full line catalog or individual specification sheets. **To locate your nearest distributor or service agency call 1-800-4-A-Miller, or visit us at www.MillerWelds.com on the web.**



Working as hard as you do – every power source from Miller is backed by the most hassle-free warranty in the business.



TABLE OF CONTENTS

SECTION 1 – SAFETY PRECAUTIONS - READ BEFORE USING	1
1-1. Symbol Usage	1
1-2. Arc Welding Hazards	1
1-3. Additional Symbols For Installation, Operation, And Maintenance	3
1-4. California Proposition 65 Warnings	4
1-5. Principal Safety Standards	4
1-6. EMF Information	4
SECTION 2 – CONSIGNES DE SÉCURITÉ – LIRE AVANT UTILISATION	5
2-1. Symboles utilisés	5
2-2. Dangers relatifs au soudage à l'arc	5
2-3. Dangers supplémentaires en relation avec l'installation, le fonctionnement et la maintenance	7
2-4. Proposition californienne 65 Avertissements	8
2-5. Principales normes de sécurité	9
2-6. Informations relatives aux CEM	9
SECTION 3 – DEFINITIONS (CE Models)	11
3-1. Warning Label Definitions	11
3-2. WEEE Label (For Products Sold Within The EU)	12
3-3. Symbols And Definitions	13
SECTION 4 – INSTALLATION	14
4-1. Important Information Regarding CE Products (Sold Within The EU)	14
4-2. Serial Number And Rating Label Location	14
4-3. Specifications	15
4-4. Volt-Ampere Curves	16
4-5. Duty Cycle And Overheating	17
4-6. Selecting A Location	18
4-7. Weld Output Terminals And Selecting Cable Sizes*	19
4-8. Remote 14 Receptacle Information	20
4-9. Automation 10-Pin Connection (LX Models)	21
4-10. Typical Automation Application	21
4-11. Gas Connections	22
4-12. TIG HF Impulse/ Lift-Arc DCEN (Direct Current Electrode Negative) Connections	22
4-13. Stick DCEP (Direct Current Electrode Positive) Connections	23
4-14. TIGRunner Connections	24
4-15. Electrical Service Guide	25
4-16. Connecting Input Power	26
SECTION 5 – OPERATION	28
5-1. Controls	28
5-2. Encoder Control	29
5-3. Amperage Control	29
5-4. Ammeter And Parameter Display	29
5-5. Voltmeter	30
5-6. Process Control	30
5-7. Lift-ArcE And HF TIG Start Procedures	31
5-8. Output Control	32
5-9. Pulser Control (DX And LX Models)	33
5-10. Sequencer Controls (DX Models Only)	34
5-11. Adjust Controls (Prewflow/Post Flow/DIG/Purge)	35
5-12. Spot Time Control (Reconfigured RMT 2T HOLD Output Selection)	36
5-13. Factory Parameter Defaults And Range And Resolution	36
5-14. Resetting Unit To Factory Default Settings (All Models)	37
5-15. Arc Timer/Counter Display	38

TABLE OF CONTENTS

SECTION 6 – ADVANCED FUNCTIONS	39
6-1. Accessing Advanced Functions	39
6-2. Programmable TIG Start Parameters	40
6-3. Output Control And Trigger Functions	44
6-4. Setting Preflow Time	50
6-5. Stick Open-Circuit Voltage (OCV) Selection	50
6-6. Stick Stuck Check Selection	50
6-7. Lockout Functions	51
6-8. Setting Unit To Display PPP While Pulse Welding (DX Models Only)	53
6-9. External Pulse Control	53
SECTION 7 – MAINTENANCE AND TROUBLESHOOTING	54
7-1. Routine Maintenance	54
7-2. Blowing Out Inside Of Unit	55
7-3. Voltmeter/Ammeter Help Displays	56
7-4. Troubleshooting	57
SECTION 8 – ELECTRICAL DIAGRAMS	59
SECTION 9 – HIGH FREQUENCY (HF)	60
9-1. Welding Processes Requiring High Frequency	60
9-2. Correct Installation	60
SECTION 10 – SETUP GUIDES FOR (GTAW) TIG WELDING	61
10-1. DC - GTAW 16 Gauge Stainless Steel Set-Up	61
SECTION 11 – SELECTING AND PREPARING A TUNGSTEN FOR DC OR AC WELDING WITH INVERTER MACHINES	62
11-1. Selecting Tungsten Electrode (Wear Clean gloves To Prevent Contamination Of Tungsten)	62
11-2. Preparing Tungsten Electrode For DC Electrode Negative (DCEN) Welding Or AC Welding With Inverter Machines	62
SECTION 12 – GUIDELINES FOR TIG WELDING (GTAW)	63
12-1. Positioning The Torch	63
12-2. Torch Movement During Welding	64
12-3. Positioning Torch Tungsten For Various Weld Joints	64
SECTION 13 – SETUP GUIDE FOR (SMAW) STICK WELDING	65
13-1. Front Panel Display For Stick DCEP (Direct Current Electrode Positive)	65
SECTION 14 – STICK WELDING (SMAW) GUIDELINES	66
SECTION 15 – PARTS LIST	74
SECTION 16 – COOLER PARTS LIST	84
SECTION 17 – CART PARTS LIST	86
OPTIONS AND ACCESSORIES	
WARRANTY	



DECLARATION OF CONFORMITY

for European Community (CE marked) products.

MILLER Electric Mfg. Co., 1635 Spencer Street, Appleton, WI 54914 U.S.A. declares that the product(s) identified in this declaration conform to the essential requirements and provisions of the stated Council Directive(s) and Standard(s).

Product/Apparatus Identification:

Product	Stock Number
Maxstar 200 DX	907354
MAXSTAR 200 DX W/CROWBAR, CE (NSPR)	907354001

Council Directives:

- 2006/95/EC Low Voltage
- 2004/108/EC Electromagnetic Compatibility

Standards:

- IEC 60974-1:2005 Arc welding equipment – Part 1: Welding power sources
- IEC 60974-3:2007 Arc welding equipment – Part 3: Arc striking and stabilizing devices
- IEC 60974-10:2007 Arc Welding Equipment – Part 10: Electromagnetic compatibility (EMC) requirements
- EN 50445:2008 Product family standard to demonstrate compliance of equipment for resistance welding, arc welding and allied processes with the basic restrictions related to human exposure to electromagnetic fields (0 Hz – 300Hz)

US Signatory:

August 22, 2009

David A. Werba

Date of Declaration

MANAGER, PRODUCT DESIGN COMPLIANCE

241515-B

SECTION 1 – SAFETY PRECAUTIONS - READ BEFORE USING

som_2010-03

 Protect yourself and others from injury — read and follow these precautions.

1-1. Symbol Usage



DANGER! – Indicates a hazardous situation which, if not avoided, will result in death or serious injury. The possible hazards are shown in the adjoining symbols or explained in the text.



Indicates a hazardous situation which, if not avoided, could result in death or serious injury. The possible hazards are shown in the adjoining symbols or explained in the text.

NOTICE – Indicates statements not related to personal injury.

 Indicates special instructions.



This group of symbols means Warning! Watch Out! ELECTRIC SHOCK, MOVING PARTS, and HOT PARTS hazards. Consult symbols and related instructions below for necessary actions to avoid the hazards.

1-2. Arc Welding Hazards



The symbols shown below are used throughout this manual to call attention to and identify possible hazards. When you see the symbol, watch out, and follow the related instructions to avoid the hazard. The safety information given below is only a summary of the more complete safety information found in the Safety Standards listed in Section 1-5. Read and follow all Safety Standards.



Only qualified persons should install, operate, maintain, and repair this unit.



During operation, keep everybody, especially children, away.



ELECTRIC SHOCK can kill.

Touching live electrical parts can cause fatal shocks or severe burns. The electrode and work circuit is electrically live whenever the output is on. The input power circuit and machine internal circuits are also live when power is on. In semiautomatic or automatic wire welding, the wire, wire reel, drive roll housing, and all metal parts touching the welding wire are electrically live. Incorrectly installed or improperly grounded equipment is a hazard.

- Do not touch live electrical parts.
- Wear dry, hole-free insulating gloves and body protection.
- Insulate yourself from work and ground using dry insulating mats or covers big enough to prevent any physical contact with the work or ground.
- Do not use AC output in damp areas, if movement is confined, or if there is a danger of falling.
- Use AC output ONLY if required for the welding process.
- If AC output is required, use remote output control if present on unit.
- Additional safety precautions are required when any of the following electrically hazardous conditions are present: in damp locations or while wearing wet clothing; on metal structures such as floors, gratings, or scaffolds; when in cramped positions such as sitting, kneeling, or lying; or when there is a high risk of unavoidable or accidental contact with the workpiece or ground. For these conditions, use the following equipment in order presented: 1) a semiautomatic DC constant voltage (wire) welder, 2) a DC manual (stick) welder, or 3) an AC welder with reduced open-circuit voltage. In most situations, use of a DC, constant voltage wire welder is recommended. And, do not work alone!
- Disconnect input power or stop engine before installing or servicing this equipment. Lockout/tagout input power according to OSHA 29 CFR 1910.147 (see Safety Standards).

- Properly install and ground this equipment according to its Owner's Manual and national, state, and local codes.
- Always verify the supply ground – check and be sure that input power cord ground wire is properly connected to ground terminal in disconnect box or that cord plug is connected to a properly grounded receptacle outlet.
- When making input connections, attach proper grounding conductor first – double-check connections.
- Keep cords dry, free of oil and grease, and protected from hot metal and sparks.
- Frequently inspect input power cord for damage or bare wiring – replace cord immediately if damaged – bare wiring can kill.
- Turn off all equipment when not in use.
- Do not use worn, damaged, undersized, or poorly spliced cables.
- Do not drape cables over your body.
- If earth grounding of the workpiece is required, ground it directly with a separate cable.
- Do not touch electrode if you are in contact with the work, ground, or another electrode from a different machine.
- Do not touch electrode holders connected to two welding machines at the same time since double open-circuit voltage will be present.
- Use only well-maintained equipment. Repair or replace damaged parts at once. Maintain unit according to manual.
- Wear a safety harness if working above floor level.
- Keep all panels and covers securely in place.
- Clamp work cable with good metal-to-metal contact to workpiece or worktable as near the weld as practical.
- Insulate work clamp when not connected to workpiece to prevent contact with any metal object.
- Do not connect more than one electrode or work cable to any single weld output terminal.

SIGNIFICANT DC VOLTAGE exists in inverter welding power sources AFTER removal of input power.

- Turn Off inverter, disconnect input power, and discharge input capacitors according to instructions in Maintenance Section before touching any parts.



HOT PARTS can burn.

- Do not touch hot parts bare handed.
- Allow cooling period before working on equipment.
- To handle hot parts, use proper tools and/or wear heavy, insulated welding gloves and clothing to prevent burns.



FUMES AND GASES can be hazardous.

Welding produces fumes and gases. Breathing these fumes and gases can be hazardous to your health.

- Keep your head out of the fumes. Do not breathe the fumes.
- If inside, ventilate the area and/or use local forced ventilation at the arc to remove welding fumes and gases.
- If ventilation is poor, wear an approved air-supplied respirator.
- Read and understand the Material Safety Data Sheets (MSDSs) and the manufacturer's instructions for metals, consumables, coatings, cleaners, and degreasers.
- Work in a confined space only if it is well ventilated, or while wearing an air-supplied respirator. Always have a trained watch-person nearby. Welding fumes and gases can displace air and lower the oxygen level causing injury or death. Be sure the breathing air is safe.
- Do not weld in locations near degreasing, cleaning, or spraying operations. The heat and rays of the arc can react with vapors to form highly toxic and irritating gases.
- Do not weld on coated metals, such as galvanized, lead, or cadmium plated steel, unless the coating is removed from the weld area, the area is well ventilated, and while wearing an air-supplied respirator. The coatings and any metals containing these elements can give off toxic fumes if welded.



ARC RAYS can burn eyes and skin.

Arc rays from the welding process produce intense visible and invisible (ultraviolet and infrared) rays that can burn eyes and skin. Sparks fly off from the weld.

- Wear an approved welding helmet fitted with a proper shade of filter lenses to protect your face and eyes from arc rays and sparks when welding or watching (see ANSI Z49.1 and Z87.1 listed in Safety Standards).
- Wear approved safety glasses with side shields under your helmet.
- Use protective screens or barriers to protect others from flash, glare and sparks; warn others not to watch the arc.
- Wear protective clothing made from durable, flame-resistant material (leather, heavy cotton, or wool) and foot protection.



WELDING can cause fire or explosion.

Welding on closed containers, such as tanks, drums, or pipes, can cause them to blow up. Sparks can fly off from the welding arc. The flying sparks, hot workpiece, and hot equipment can cause fires and burns. Accidental contact of electrode to metal objects can cause sparks, explosion, overheating, or fire. Check and be sure the area is safe before doing any welding.

- Remove all flammables within 35 ft (10.7 m) of the welding arc. If this is not possible, tightly cover them with approved covers.
- Do not weld where flying sparks can strike flammable material.
- Protect yourself and others from flying sparks and hot metal.
- Be alert that welding sparks and hot materials from welding can easily go through small cracks and openings to adjacent areas.
- Watch for fire, and keep a fire extinguisher nearby.
- Be aware that welding on a ceiling, floor, bulkhead, or partition can cause fire on the hidden side.
- Do not weld on closed containers such as tanks, drums, or pipes, unless they are properly prepared according to AWS F4.1 (see Safety Standards).
- Do not weld where the atmosphere may contain flammable dust, gas, or liquid vapors (such as gasoline).
- Connect work cable to the work as close to the welding area as practical to prevent welding current from traveling long, possibly unknown paths and causing electric shock, sparks, and fire hazards.
- Do not use welder to thaw frozen pipes.

- Remove stick electrode from holder or cut off welding wire at contact tip when not in use.
- Wear oil-free protective garments such as leather gloves, heavy shirt, cuffless trousers, high shoes, and a cap.
- Remove any combustibles, such as a butane lighter or matches, from your person before doing any welding.
- After completion of work, inspect area to ensure it is free of sparks, glowing embers, and flames.
- Use only correct fuses or circuit breakers. Do not oversize or bypass them.
- Follow requirements in OSHA 1910.252 (a) (2) (iv) and NFPA 51B for hot work and have a fire watcher and extinguisher nearby.

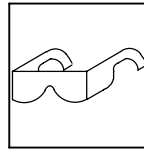

FLYING METAL or DIRT can injure eyes.

- Welding, chipping, wire brushing, and grinding cause sparks and flying metal. As welds cool, they can throw off slag.
- Wear approved safety glasses with side shields even under your welding helmet.



BUILDUP OF GAS can injure or kill.

- Shut off shielding gas supply when not in use.
- Always ventilate confined spaces or use approved air-supplied respirator.

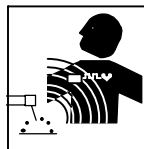

ELECTRIC AND MAGNETIC FIELDS (EMF) can affect Implanted Medical Devices.

- Wearers of Pacemakers and other Implanted Medical Devices should keep away.
- Implanted Medical Device wearers should consult their doctor and the device manufacturer before going near arc welding, spot welding, gouging, plasma arc cutting, or induction heating operations.

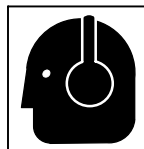

NOISE can damage hearing.

Noise from some processes or equipment can damage hearing.

- Wear approved ear protection if noise level is high.

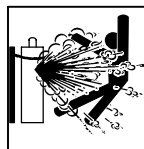

CYLINDERS can explode if damaged.

Shielding gas cylinders contain gas under high pressure. If damaged, a cylinder can explode. Since gas cylinders are normally part of the welding process, be sure to treat them carefully.

- Protect compressed gas cylinders from excessive heat, mechanical shocks, physical damage, slag, open flames, sparks, and arcs.
- Install cylinders in an upright position by securing to a stationary support or cylinder rack to prevent falling or tipping.
- Keep cylinders away from any welding or other electrical circuits.
- Never drape a welding torch over a gas cylinder.
- Never allow a welding electrode to touch any cylinder.
- Never weld on a pressurized cylinder – explosion will result.
- Use only correct shielding gas cylinders, regulators, hoses, and fittings designed for the specific application; maintain them and associated parts in good condition.
- Turn face away from valve outlet when opening cylinder valve.
- Keep protective cap in place over valve except when cylinder is in use or connected for use.
- Use the right equipment, correct procedures, and sufficient number of persons to lift and move cylinders.
- Read and follow instructions on compressed gas cylinders, associated equipment, and Compressed Gas Association (CGA) publication P-1 listed in Safety Standards.

1-3. Additional Symbols For Installation, Operation, And Maintenance



FIRE OR EXPLOSION hazard.

- Do not install or place unit on, over, or near combustible surfaces.
- Do not install unit near flammables.
- Do not overload building wiring – be sure power supply system is properly sized, rated, and protected to handle this unit.



FALLING EQUIPMENT can injure.

- Use lifting eye to lift unit only, NOT running gear, gas cylinders, or any other accessories.
- Use equipment of adequate capacity to lift and support unit.
- If using lift forks to move unit, be sure forks are long enough to extend beyond opposite side of unit.
- Keep equipment (cables and cords) away from moving vehicles when working from an aerial location.
- Follow the guidelines in the Applications Manual for the Revised NIOSH Lifting Equation (Publication No. 94-110) when manually lifting heavy parts or equipment.

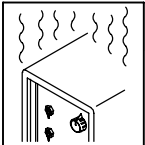

OVERUSE can cause OVERHEATING

- Allow cooling period; follow rated duty cycle.
- Reduce current or reduce duty cycle before starting to weld again.
- Do not block or filter airflow to unit.

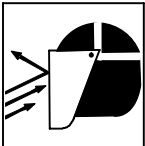

FLYING SPARKS can injure.

- Wear a face shield to protect eyes and face.
- Shape tungsten electrode only on grinder with proper guards in a safe location wearing proper face, hand, and body protection.
- Sparks can cause fires — keep flammables away.

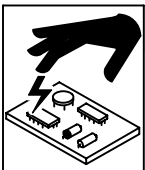

STATIC (ESD) can damage PC boards.

- Put on grounded wrist strap BEFORE handling boards or parts.
- Use proper static-proof bags and boxes to store, move, or ship PC boards.



MOVING PARTS can injure.

- Keep away from moving parts.
- Keep away from pinch points such as drive rolls.



WELDING WIRE can injure.

- Do not press gun trigger until instructed to do so.
- Do not point gun toward any part of the body, other people, or any metal when threading welding wire.



MOVING PARTS can injure.

- Keep away from moving parts such as fans.
- Keep all doors, panels, covers, and guards closed and securely in place.
- Have only qualified persons remove doors, panels, covers, or guards for maintenance and troubleshooting as necessary.
- Reinstall doors, panels, covers, or guards when maintenance is finished and before reconnecting input power.

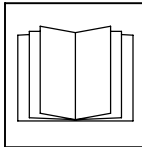

READ INSTRUCTIONS.

- Read and follow all labels and the Owner's Manual carefully before installing, operating, or servicing unit. Read the safety information at the beginning of the manual and in each section.
- Use only genuine replacement parts from the manufacturer.
- Perform maintenance and service according to the Owner's Manuals, industry standards, and national, state, and local codes.

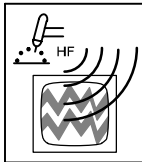

H.F. RADIATION can cause interference.

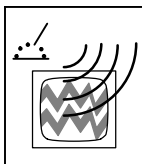

- High-frequency (H.F.) can interfere with radio navigation, safety services, computers, and communications equipment.
- Have only qualified persons familiar with electronic equipment perform this installation.
- The user is responsible for having a qualified electrician promptly correct any interference problem resulting from the installation.
- If notified by the FCC about interference, stop using the equipment at once.
- Have the installation regularly checked and maintained.
- Keep high-frequency source doors and panels tightly shut, keep spark gaps at correct setting, and use grounding and shielding to minimize the possibility of interference.



ARC WELDING can cause interference.

- Electromagnetic energy can interfere with sensitive electronic equipment such as computers and computer-driven equipment such as robots.
- Be sure all equipment in the welding area is electromagnetically compatible.
- To reduce possible interference, keep weld cables as short as possible, close together, and down low, such as on the floor.
- Locate welding operation 100 meters from any sensitive electronic equipment.
- Be sure this welding machine is installed and grounded according to this manual.
- If interference still occurs, the user must take extra measures such as moving the welding machine, using shielded cables, using line filters, or shielding the work area.

1-4. California Proposition 65 Warnings

-  **Welding or cutting equipment produces fumes or gases which contain chemicals known to the State of California to cause birth defects and, in some cases, cancer. (California Health & Safety Code Section 25249.5 et seq.)**
-  **Battery posts, terminals and related accessories contain lead and lead compounds, chemicals known to the State of California to cause cancer and birth defects or other reproductive harm. *Wash hands after handling.***
-  **This product contains chemicals, including lead, known to the state of California to cause cancer, birth defects, or other reproductive harm. *Wash hands after use.***

For Gasoline Engines:

-  **Engine exhaust contains chemicals known to the State of California to cause cancer, birth defects, or other reproductive harm.**

For Diesel Engines:

-  **Diesel engine exhaust and some of its constituents are known to the State of California to cause cancer, birth defects, and other reproductive harm.**

1-5. Principal Safety Standards

Safety in Welding, Cutting, and Allied Processes, ANSI Standard Z49.1, from Global Engineering Documents (phone: 1-877-413-5184, website: www.global.ihs.com).

Safe Practices for the Preparation of Containers and Piping for Welding and Cutting, American Welding Society Standard AWS F4.1, from Global Engineering Documents (phone: 1-877-413-5184, website: www.global.ihs.com).

National Electrical Code, NFPA Standard 70, from National Fire Protection Association, Quincy, MA 02269 (phone: 1-800-344-3555, website: www.nfpa.org and www.sparky.org).

Safe Handling of Compressed Gases in Cylinders, CGA Pamphlet P-1, from Compressed Gas Association, 4221 Walney Road, 5th Floor, Chantilly, VA 20151 (phone: 703-788-2700, website: www.cganet.com).

Safety in Welding, Cutting, and Allied Processes, CSA Standard W117.2, from Canadian Standards Association, Standards Sales, 5060 Spectrum Way, Suite 100, Ontario, Canada L4W 5N5 (phone: 800-463-6727, website: www.csa-international.org).

Safe Practice For Occupational And Educational Eye And Face Protection, ANSI Standard Z87.1, from American National Standards Institute,

25 West 43rd Street, New York, NY 10036 (phone: 212-642-4900, website: www.ansi.org).

Standard for Fire Prevention During Welding, Cutting, and Other Hot Work, NFPA Standard 51B, from National Fire Protection Association, Quincy, MA 02269 (phone: 1-800-344-3555, website: www.nfpa.org).

OSHA, Occupational Safety and Health Standards for General Industry, Title 29, Code of Federal Regulations (CFR), Part 1910, Subpart Q, and Part 1926, Subpart J, from U.S. Government Printing Office, Superintendent of Documents, P.O. Box 371954, Pittsburgh, PA 15250-7954 (phone: 1-866-512-1800) (there are 10 OSHA Regional Offices—phone for Region 5, Chicago, is 312-353-2220, website: www.osha.gov).

U.S. Consumer Product Safety Commission (CPSC), 4330 East West Highway, Bethesda, MD 20814 (phone: 301-504-7923, website: www.cpsc.gov).

Applications Manual for the Revised NIOSH Lifting Equation, The National Institute for Occupational Safety and Health (NIOSH), 1600 Clifton Rd, Atlanta, GA 30333 (phone: 1-800-232-4636, website: www.cdc.gov/NIOSH).

1-6. EMF Information

Electric current flowing through any conductor causes localized electric and magnetic fields (EMF). Welding current creates an EMF field around the welding circuit and welding equipment. EMF fields may interfere with some medical implants, e.g. pacemakers. Protective measures for persons wearing medical implants have to be taken. For example, access restrictions for passers-by or individual risk assessment for welders. All welders should use the following procedures in order to minimize exposure to EMF fields from the welding circuit:

1. Keep cables close together by twisting or taping them, or using a cable cover.
2. Do not place your body between welding cables. Arrange cables to one side and away from the operator.
3. Do not coil or drape cables around your body.

4. Keep head and trunk as far away from the equipment in the welding circuit as possible.
5. Connect work clamp to workpiece as close to the weld as possible.
6. Do not work next to, sit or lean on the welding power source.
7. Do not weld whilst carrying the welding power source or wire feeder.

About Implanted Medical Devices:

Implanted Medical Device wearers should consult their doctor and the device manufacturer before performing or going near arc welding, spot welding, gouging, plasma arc cutting, or induction heating operations. If cleared by your doctor, then following the above procedures is recommended.

SECTION 2 – CONSIGNES DE SÉCURITÉ – LIRE AVANT UTILISATION

fre_som_2010-03

! Se protéger et protéger les autres contre le risque de blessure — lire et respecter ces consignes.

2-1. Symboles utilisés



DANGER! – Indique une situation dangereuse qui si on l'évite pas peut donner la mort ou des blessures graves. Les dangers possibles sont montrés par les symboles joints ou sont expliqués dans le texte.



Indique une situation dangereuse qui si on l'évite pas peut donner la mort ou des blessures graves. Les dangers possibles sont montrés par les symboles joints ou sont expliqués dans le texte.

NOTE – Indique des déclarations pas en relation avec des blessures personnelles.

 Indique des instructions spécifiques.



Ce groupe de symboles veut dire Avertissement! Attention! DANGER DE CHOC ELECTRIQUE, PIECES EN MOUVEMENT, et PIECES CHAUDES. Consulter les symboles et les instructions ci-dessous y afférant pour les actions nécessaires afin d'éviter le danger.

2-2. Dangers relatifs au soudage à l'arc



Les symboles représentés ci-dessous sont utilisés dans ce manuel pour attirer l'attention et identifier les dangers possibles. En présence de l'un de ces symboles, prendre garde et suivre les instructions afférentes pour éviter tout risque. Les instructions en matière de sécurité indiquées ci-dessous ne constituent qu'un sommaire des instructions de sécurité plus complètes fournies dans les normes de sécurité énumérées dans la Section 2-5. Lire et observer toutes les normes de sécurité.



Seul un personnel qualifié est autorisé à installer, faire fonctionner, entretenir et réparer cet appareil.



Pendant le fonctionnement, maintenir à distance toutes les personnes, notamment les enfants de l'appareil.



UNE DÉCHARGE ÉLECTRIQUE peut entraîner la mort.

Le contact d'organes électriques sous tension peut provoquer des accidents mortels ou des brûlures graves. Le circuit de l'électrode et de la pièce est sous tension lorsque le courant est délivré à la sortie. Le circuit d'alimentation et les circuits internes de la machine sont également sous tension lorsque l'alimentation est sur Marche. Dans le mode de soudage avec du fil, le fil, le dérouleur, le bloc de commande du rouleau et toutes les parties métalliques en contact avec le fil sont sous tension électrique. Un équipement installé ou mis à la terre de manière incorrecte ou impropre constitue un danger.

- Ne pas toucher aux pièces électriques sous tension.
 - Porter des gants isolants et des vêtements de protection secs et sans trous.
 - S'isoler de la pièce à couper et du sol en utilisant des housses ou des tapis assez grands afin d'éviter tout contact physique avec la pièce à couper ou le sol.
 - Ne pas se servir de source électrique à courant électrique dans les zones humides, dans les endroits confinés ou là où on risque de tomber.
 - Se servir d'une source électrique à courant électrique UNIQUEMENT si le procédé de soudage le demande.
 - Si l'utilisation d'une source électrique à courant électrique s'avère nécessaire, se servir de la fonction de télécommande si l'appareil en est équipé.
 - D'autres consignes de sécurité sont nécessaires dans les conditions suivantes : risques électriques dans un environnement humide ou si l'on porte des vêtements mouillés ; sur des structures métalliques telles que sols, grilles ou échafaudages ; en position coincée comme assise, à genoux ou couchée ; ou s'il y a un risque élevé de contact inévitable ou accidentel avec la pièce à souder ou le sol. Dans ces conditions, utiliser les équipements suivants,
- dans l'ordre indiqué : 1) un poste à souder DC à tension constante (à fil), 2) un poste à souder DC manuel (électrode) ou 3) un poste à souder AC à tension à vide réduite. Dans la plupart des situations, l'utilisation d'un poste à souder DC à fil à tension constante est recommandée. En outre, ne pas travailler seul !
 - Couper l'alimentation ou arrêter le moteur avant de procéder à l'installation, à la réparation ou à l'entretien de l'appareil. Déverrouiller l'alimentation selon la norme OSHA 29 CFR 1910.147 (voir normes de sécurité).
 - Installer le poste correctement et le mettre à la terre convenablement selon les consignes du manuel de l'opérateur et les normes nationales, provinciales et locales.
 - Toujours vérifier la terre du cordon d'alimentation. Vérifier et s'assurer que le fil de terre du cordon d'alimentation est bien raccordé à la borne de terre du sectionneur ou que la fiche du cordon est raccordée à une prise correctement mise à la terre.
 - En effectuant les raccordements d'entrée, fixer d'abord le conducteur de mise à la terre approprié et contre-vérifier les connexions.
 - Les câbles doivent être exempts d'humidité, d'huile et de graisse; protégez-les contre les étincelles et les pièces métalliques chaudes.
 - Vérifier fréquemment le cordon d'alimentation afin de s'assurer qu'il n'est pas altéré ou à nu, le remplacer immédiatement s'il l'est. Un fil à nu peut entraîner la mort.
 - L'équipement doit être hors tension lorsqu'il n'est pas utilisé.
 - Ne pas utiliser des câbles usés, endommagés, de grosseur insuffisante ou mal épissés.
 - Ne pas enrouler les câbles autour du corps.
 - Si la pièce soudée doit être mise à la terre, le faire directement avec un câble distinct.
 - Ne pas toucher l'électrode quand on est en contact avec la pièce, la terre ou une électrode provenant d'une autre machine.
 - Ne pas toucher des porte électrodes connectés à deux machines en même temps à cause de la présence d'une tension à vide doublée.
 - N'utiliser qu'un matériel en bon état. Réparer ou remplacer sur-le-champ les pièces endommagées. Entretenir l'appareil conformément à ce manuel.
 - Porter un harnais de sécurité si l'on doit travailler au-dessus du sol.
 - S'assurer que tous les panneaux et couvercles sont correctement en place.
 - Fixer le câble de retour de façon à obtenir un bon contact métal-métal avec la pièce à souder ou la table de travail, le plus près possible de la soudure.
 - Isoler la pince de masse quand pas mis à la pièce pour éviter le contact avec tout objet métallique.
 - Ne pas raccorder plus d'une électrode ou plus d'un câble de masse à une même borne de sortie de soudage.

Il reste une TENSION DC NON NÉGLIGEABLE dans les sources de soudage onduleur UNE FOIS l'alimentation coupée.

- Arrêter les convertisseurs, débrancher le courant électrique et décharger les condensateurs d'alimentation selon les instructions indiquées dans la partie Entretien avant de toucher les pièces.



LES PIÈCES CHAUDES peuvent provoquer des brûlures.

- Ne pas toucher à mains nues les parties chaudes.
- Prévoir une période de refroidissement avant de travailler à l'équipement.
- Ne pas toucher aux pièces chaudes, utiliser les outils recommandés et porter des gants de soudage et des vêtements épais pour éviter les brûlures.



LES FUMÉES ET LES GAZ peuvent être dangereux.

Le soudage génère des fumées et des gaz. Leur inhalation peut être dangereux pour votre santé.

- Eloigner votre tête des fumées. Ne pas respirer les fumées.
- À l'intérieur, ventiler la zone et/ou utiliser une ventilation forcée au niveau de l'arc pour l'évacuation des fumées et des gaz de soudage.
- Si la ventilation est médiocre, porter un respirateur anti-vapeurs approuvé.
- Lire et comprendre les spécifications de sécurité des matériaux (MSDS) et les instructions du fabricant concernant les métaux, les consommables, les revêtements, les nettoyants et les dégraissants.
- Travailler dans un espace fermé seulement s'il est bien ventilé ou en portant un respirateur à alimentation d'air. Demander toujours à un surveillant dûment formé de se tenir à proximité. Des fumées et des gaz de soudage peuvent déplacer l'air et abaisser le niveau d'oxygène provoquant des blessures ou des accidents mortels. S'assurer que l'air de respiration ne présente aucun danger.
- Ne pas souder dans des endroits situés à proximité d'opérations de dégraissage, de nettoyage ou de pulvérisation. La chaleur et les rayons de l'arc peuvent réagir en présence de vapeurs et former des gaz hautement toxiques et irritants.
- Ne pas souder des métaux munis d'un revêtement, tels que l'acier galvanisé, plaqué en plomb ou au cadmium à moins que le revêtement n'ait été enlevé dans la zone de soudure, que l'endroit soit bien ventilé, et en portant un respirateur à alimentation d'air. Les revêtements et tous les métaux renfermant ces éléments peuvent dégager des fumées toxiques en cas de soudage.



LES RAYONS DE L'ARC peuvent provoquer des brûlures dans les yeux et sur la peau.

Le rayonnement de l'arc du procédé de soudage génère des rayons visibles et invisibles intense (ultraviolets et infrarouges) susceptibles de provoquer des brûlures dans les yeux et sur la peau. Des étincelles sont projetées pendant le soudage.

- Porter un casque de soudage approuvé muni de verres filtrants appropriés pour protéger visage et yeux pour protéger votre visage et vos yeux pendant le soudage ou pour regarder (voir ANSI Z49.1 et Z87.1 énuméré dans les normes de sécurité).
- Porter des lunettes de sécurité avec écrans latéraux même sous votre casque.
- Avoir recours à des écrans protecteurs ou à des rideaux pour protéger les autres contre les rayonnements les éblouissements et les étincelles ; prévenir toute personne sur les lieux de ne pas regarder l'arc.
- Porter des vêtements confectionnés avec des matières résistantes et ignifuges (cuir, coton lourd ou laine) et des bottes de protection.

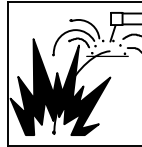

LE SOUDAGE peut provoquer un incendie ou une explosion.

Le soudage effectué sur des conteneurs fermés tels que des réservoirs, tambours ou des conduites peut provoquer leur éclatement. Des étincelles peuvent être projetées de l'arc de soudure. La projection d'étincelles, des pièces chaudes et des équipements chauds peut provoquer des incendies et des brûlures. Le contact accidentel de l'électrode avec des objets métalliques peut provoquer des étincelles, une explosion, un surchauffement ou un incendie. Avant de commencer le soudage, vérifier et s'assurer que l'endroit ne présente pas de danger.

- Déplacer toutes les substances inflammables à une distance de 10,7 m de l'arc de soudage. En cas d'impossibilité les recouvrir soigneusement avec des protections homologués.
- Ne pas souder dans un endroit où des étincelles peuvent tomber sur des substances inflammables.
- Se protéger et d'autres personnes de la projection d'étincelles et de métal chaud.
- Des étincelles et des matériaux chauds du soudage peuvent facilement passer dans d'autres zones en traversant de petites fissures et des ouvertures.
- Surveiller tout déclenchement d'incendie et tenir un extincteur à proximité.
- Le soudage effectué sur un plafond, plancher, paroi ou séparation peut déclencher un incendie de l'autre côté.
- Ne pas effectuer le soudage sur des conteneurs fermés tels que des réservoirs, tambours, ou conduites, à moins qu'ils n'aient été préparés correctement conformément à AWS F4.1 (voir les normes de sécurité).
- Ne soudez pas si l'air ambiant est chargé de particules, gaz, ou vapeurs inflammables (vapeur d'essence, par exemple).
- Brancher le câble de masse sur la pièce la plus près possible de la zone de soudage pour éviter le transport du courant sur une longue distance par des chemins inconnus éventuels en provoquant des risques d'électrocution, d'étincelles et d'incendie.
- Ne pas utiliser le poste de soudage pour dégeler des conduites gelées.
- En cas de non utilisation, enlever la baguette d'électrode du porte-électrode ou couper le fil à la pointe de contact.
- Porter des vêtements de protection dépourvus d'huile tels que des gants en cuir, une chemise en matériau lourd, des pantalons sans revers, des chaussures hautes et un couvre chef.
- Avant de souder, retirer toute substance combustible de vos poches telles qu'un allumeur au butane ou des allumettes.
- Une fois le travail achevé, assurez-vous qu'il ne reste aucune trace d'étincelles incandescentes ni de flammes.
- Utiliser exclusivement des fusibles ou coupe-circuits appropriés. Ne pas augmenter leur puissance; ne pas les ponter.
- Une fois le travail achevé, assurez-vous qu'il ne reste aucune trace d'étincelles incandescentes ni de flammes.
- Utiliser exclusivement des fusibles ou coupe-circuits appropriés. Ne pas augmenter leur puissance; ne pas les ponter.
- Suivre les recommandations dans OSHA 1910.252(a)(2)(iv) et NFPA 51B pour les travaux à chaud et avoir de la surveillance et un extincteur à proximité.

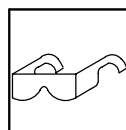

DES PIÈCES DE METAL ou DES SALETES peuvent provoquer des blessures dans les yeux.

- Le soudage, l'écaillage, le passage de la pièce à la brosse en fil de fer, et le meulage génèrent des étincelles et des particules métalliques volantes. Pendant la période de refroidissement des soudures, elles risquent de projeter du laitier.
- Porter des lunettes de sécurité avec écrans latéraux ou un écran facial.



LES ACCUMULATIONS DE GAZ risquent de provoquer des blessures ou même la mort.

- Fermer l'alimentation du gaz protecteur en cas de non-utilisation.
- Veiller toujours à bien aérer les espaces confinés ou se servir d'un respirateur d'adduction d'air homologué.



Les CHAMPS ÉLECTROMAGNÉTIQUES (CEM) peuvent affecter les implants médicaux.

- Les porteurs de stimulateurs cardiaques et autres implants médicaux doivent rester à distance.
- Les porteurs d'implants médicaux doivent consulter leur médecin et le fabricant du dispositif avant de s'approcher de la zone où se déroule du soudage à l'arc, du soudage par points, du gougeage, de la découpe plasma ou une opération de chauffage par induction.



LE BRUIT peut endommager l'ouïe.

Le bruit des processus et des équipements peut affecter l'ouïe.

- Porter des protections approuvées pour les oreilles si le niveau sonore est trop élevé.

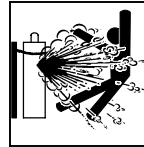

LES BOUTEILLES peuvent exploser si elles sont endommagées.

Des bouteilles de gaz protecteur contiennent du gaz sous haute pression. Si une bouteille est endommagée, elle peut exploser. Du fait que les bouteilles de gaz font normalement partie du procédé de soudage, les manipuler avec précaution.

- Protéger les bouteilles de gaz comprimé d'une chaleur excessive, des chocs mécaniques, des dommages physiques, du laitier, des flammes ouvertes, des étincelles et des arcs.
- Placer les bouteilles debout en les fixant dans un support stationnaire ou dans un porte-bouteilles pour les empêcher de tomber ou de se renverser.
- Tenir les bouteilles éloignées des circuits de soudage ou autres circuits électriques.
- Ne jamais placer une torche de soudage sur une bouteille à gaz.
- Une électrode de soudage ne doit jamais entrer en contact avec une bouteille.
- Ne jamais souder une bouteille pressurisée – risque d'explosion.
- Utiliser seulement des bouteilles de gaz protecteur, régulateurs, tuyaux et raccords convenables pour cette application spécifique ; les maintenir ainsi que les éléments associés en bon état.
- Détourner votre visage du détendeur-régulateur lorsque vous ouvrez la soupape de la bouteille.
- Le couvercle du détendeur doit toujours être en place, sauf lorsque la bouteille est utilisée ou qu'elle est reliée pour usage ultérieur.
- Utiliser les équipements corrects, les bonnes procédures et suffisamment de personnes pour soulever et déplacer les bouteilles.
- Lire et suivre les instructions sur les bouteilles de gaz comprimé, l'équipement connexe et le dépliant P-1 de la CGA (Compressed Gas Association) mentionné dans les principales normes de sécurité.

2-3. Dangers supplémentaires en relation avec l'installation, le fonctionnement et la maintenance



Risque D'INCENDIE OU D'EXPLOSION.

- Ne pas placer l'appareil sur, au-dessus ou à proximité de surfaces inflammables.
- Ne pas installer l'appareil à proximité de produits inflammables.
- Ne pas surcharger l'installation électrique – s'assurer que l'alimentation est correctement dimensionnée et protégée avant de mettre l'appareil en service.

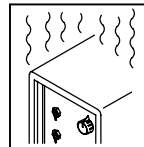

L'EMPLOI EXCESSIF peut SURCHAUFFER L'ÉQUIPEMENT.

- Prévoir une période de refroidissement ; respecter le cycle opératoire nominal.
- Réduire le courant ou le facteur de marche avant de poursuivre le soudage.
- Ne pas obstruer les passages d'air du poste.



LA CHUTE DE L'ÉQUIPEMENT peut provoquer des blessures.

- Utiliser l'anneau de levage uniquement pour soulever l'appareil, NON PAS les chariots, les bouteilles de gaz ou tout autre accessoire.
- Utiliser un équipement de levage de capacité suffisante pour lever l'appareil.
- En utilisant des fourches de levage pour déplacer l'unité, s'assurer que les fourches sont suffisamment longues pour dépasser du côté opposé de l'appareil.
- Tenir l'équipement (câbles et cordons) à distance des véhicules mobiles lors de toute opération en hauteur.
- Suivre les consignes du Manuel des applications pour l'équation de levage NIOSH révisée (Publication N°94-110) lors du levage manuel de pièces ou équipements lourds.

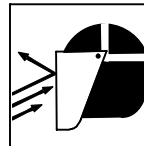

LES ÉTINCELLES PROJÉTÉES peuvent provoquer des blessures.

- Porter un écran facial pour protéger le visage et les yeux.
- Affûter l'électrode au tungstène uniquement à la meuleuse dotée de protecteurs. Cette manœuvre est à exécuter dans un endroit sûr lorsque l'on porte l'équipement homologué de protection du visage, des mains et du corps.
- Les étincelles risquent de causer un incendie – éloigner toute substance inflammable.

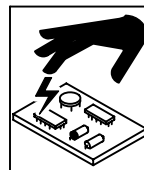

LES CHARGES ÉLECTROSTATIQUES peuvent endommager les circuits imprimés.

- Établir la connexion avec la barrette de terre avant de manipuler des cartes ou des pièces.
- Utiliser des pochettes et des boîtes antistatiques pour stocker, déplacer ou expédier des cartes de circuits imprimés.



Les PIÈCES MOBILES peuvent causer des blessures.

- Ne pas s'approcher des organes mobiles.
- Ne pas s'approcher des points de coincement tels que des rouleaux de commande.



LES FILS DE SOUDAGE peuvent provoquer des blessures.

- Ne pas appuyer sur la gâchette avant d'en avoir reçu l'instruction.
- Ne pas diriger le pistolet vers soi, d'autres personnes ou toute pièce mécanique en engageant le fil de soudage.



Les PIÈCES MOBILES peuvent causer des blessures.

- S'abstenir de toucher des organes mobiles tels que des ventilateurs.
- Maintenir fermés et verrouillés les portes, panneaux, recouvrements et dispositifs de protection.
- Lorsque cela est nécessaire pour des travaux d'entretien et de dépannage, faire retirer les portes, panneaux, recouvrements ou dispositifs de protection uniquement par du personnel qualifié.
- Remettre les portes, panneaux, recouvrements ou dispositifs de protection quand l'entretien est terminé et avant de rebrancher l'alimentation électrique.

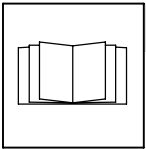

LIRE LES INSTRUCTIONS.

- Lire et appliquer les instructions sur les étiquettes et le Mode d'emploi avant l'installation, l'utilisation ou l'entretien de l'appareil. Lire les informations de sécurité au début du manuel et dans chaque section.
- N'utiliser que les pièces de rechange recommandées par le constructeur.
- Effectuer l'entretien en respectant les manuels d'utilisation, les normes industrielles et les codes nationaux, d'état et locaux.

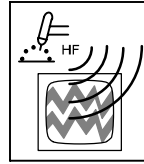

LE RAYONNEMENT HAUTE FRÉQUENCE (H.F.) risque de provoquer des interférences.

- Le rayonnement haute fréquence (H.F.) peut provoquer des interférences avec les équipements de radio-navigation et de communication, les services de sécurité et les ordinateurs.

- Demander seulement à des personnes qualifiées familiarisées avec des équipements électroniques de faire fonctionner l'installation.
- L'utilisateur est tenu de faire corriger rapidement par un électricien qualifié les interférences résultant de l'installation.
- Si le FCC signale des interférences, arrêter immédiatement l'appareil.
- Effectuer régulièrement le contrôle et l'entretien de l'installation.
- Maintenir soigneusement fermés les portes et les panneaux des sources de haute fréquence, maintenir les éclateurs à une distance correcte et utiliser une terre et un blindage pour réduire les interférences éventuelles.

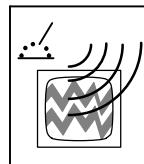

LE SOUDAGE À L'ARC risque de provoquer des interférences.

- L'énergie électromagnétique risque de provoquer des interférences pour l'équipement électronique sensible tel que les ordinateurs et l'équipement commandé par ordinateur tel que les robots.

- Veiller à ce que tout l'équipement de la zone de soudage soit compatible électromagnétiquement.
- Pour réduire la possibilité d'interférence, maintenir les câbles de soudage aussi courts que possible, les grouper, et les poser aussi bas que possible (ex. par terre).
- Veiller à souder à une distance de 100 mètres de tout équipement électronique sensible.
- Veiller à ce que ce poste de soudage soit posé et mis à la terre conformément à ce mode d'emploi.
- En cas d'interférences après avoir pris les mesures précédentes, il incombe à l'utilisateur de prendre des mesures supplémentaires telles que le déplacement du poste, l'utilisation de câbles blindés, l'utilisation de filtres de ligne ou la pose de protecteurs dans la zone de travail.

2-4. Proposition californienne 65 Avertissements

⚠ Les équipements de soudage et de coupage produisent des fumées et des gaz qui contiennent des produits chimiques dont l'État de Californie reconnaît qu'ils provoquent des malformations congénitales et, dans certains cas, des cancers. (Code de santé et de sécurité de Californie, chapitre 25249.5 et suivants)

⚠ Les batteries, les bornes et autres accessoires contiennent du plomb et des composés à base de plomb, produits chimiques dont l'État de Californie reconnaît qu'ils provoquent des cancers et des malformations congénitales ou autres problèmes de procréation. Se laver les mains après manipulation.

⚠ Ce produit contient des produits chimiques, notamment du plomb, dont l'État de Californie reconnaît qu'ils provoquent

des cancers, des malformations congénitales ou d'autres problèmes de procréation. Se laver les mains après utilisation.

Pour les moteurs à essence :

⚠ Les gaz d'échappement des moteurs contiennent des produits chimiques dont l'État de Californie reconnaît qu'ils provoquent des cancers et des malformations congénitales ou autres problèmes de procréation.

Pour les moteurs diesel :

⚠ Les gaz d'échappement des moteurs diesel et certains de leurs composants sont reconnus par l'État de Californie comme provoquant des cancers et des malformations congénitales ou autres problèmes de procréation.

2-5. Principales normes de sécurité

Safety in Welding, Cutting, and Allied Processes, ANSI Standard Z49.1, de Global Engineering Documents (téléphone : 1-877-413-5184, site Internet : www.global.ihc.com).

Safe Practices for the Preparation of Containers and Piping for Welding and Cutting, American Welding Society Standard AWS F4.1, de Global Engineering Documents (téléphone : 1-877-413-5184, site internet : www.global.ihc.com).

National Electrical Code, NFPA Standard 70, de National Fire Protection Association, Quincy, MA 02269 (téléphone : 800-344-3555, site Internet : www.nfpa.org et www.sparky.org).

Safe Handling of Compressed Gases in Cylinders, CGA Pamphlet P-1, de Compressed Gas Association, 4221 Walney Road, 5th Floor, Chantilly, VA 20151 (téléphone : 703-788-2700, site Internet : www.cganet.com).

Safety in Welding, Cutting, and Allied Processes, CSA Standard W117.2, de Canadian Standards Association, Standards Sales, 5060 Spectrum Way, Suite 100, Ontario, Canada L4W 5N5 (téléphone : 800-463-6727, site internet : www.csa-international.org).

Safe Practice For Occupational And Educational Eye And Face Protection, ANSI Standard Z87.1, de American National Standards Institute,

25 West 43rd Street, New York, NY 10036 (téléphone : 212-642-4900, site Internet : www.ansi.org).

Standard for Fire Prevention During Welding, Cutting, and Other Hot Work, NFPA Standard 51B, de National Fire Protection Association, P.O. Box 9101, Quincy, MA 02269-9101 (téléphone : 617-770-3000, site Internet : www.nfpa.org).

OSHA, Occupational Safety and Health Standards for General Industry, Title 29, Code of Federal Regulations (CFR), Part 1910, Subpart Q, and Part 1926, Subpart J, de U.S. Government Printing Office, Superintendent of Documents, P.O. Box 371954, Pittsburgh, PA 15250-7954 (téléphone : 1-866-512-1800) (il y a 10 bureaux régionaux—le téléphone de la région 5, Chicago, est 312-353-2220, site Internet : www.osha.gov).

U.S. Consumer Product Safety Commission (CPSC), 4330 East West Highway, Bethesda, MD 20814 (téléphone : 301-504-7923, site internet : www.cpsc.gov).

Applications Manual for the Revised NIOSH Lifting Equation, The National Institute for Occupational Safety and Health (NIOSH), 1600 Clifton Rd, Atlanta, GA 30333 (téléphone : 1-800-232-4636, site internet : www.cdc.gov/NIOSH).

2-6. Informations relatives aux CEM

Le courant électrique qui traverse tout conducteur génère des champs électromagnétiques (CEM) à certains endroits. Le courant de soudage crée un CEM autour du circuit et du matériel de soudage. Les CEM peuvent créer des interférences avec certains implants médicaux comme des stimulateurs cardiaques. Des mesures de protection pour les porteurs d'implants médicaux doivent être prises: par exemple, des restrictions d'accès pour les passants ou une évaluation individuelle des risques pour les soudeurs. Tous les soudeurs doivent appliquer les procédures suivantes pour minimiser l'exposition aux CEM provenant du circuit de soudage:

1. Rassembler les câbles en les torsadant ou en les attachant avec du ruban adhésif ou avec une housse.
2. Ne pas se tenir au milieu des câbles de soudage. Disposer les câbles d'un côté et à distance de l'opérateur.
3. Ne pas courber et ne pas entourer les câbles autour de votre corps.

4. Maintenir la tête et le torse aussi loin que possible du matériel du circuit de soudage.
5. Connecter la pince sur la pièce aussi près que possible de la soudure.
6. Ne pas travailler à proximité d'une source de soudage, ni s'asseoir ou se pencher dessus.
7. Ne pas souder tout en portant la source de soudage ou le dévidoir.

En ce qui concerne les implants médicaux :

Les porteurs d'implants doivent d'abord consulter leur médecin avant de s'approcher des opérations de soudage à l'arc, de soudage par points, de gougeage, du coupage plasma ou de chauffage par induction. Si le médecin approuve, il est recommandé de suivre les procédures précédentes.

SECTION 3 – DEFINITIONS (CE Models)

3-1. Warning Label Definitions

Warning! Watch Out! There are possible hazards as shown by the symbols.

1 Electric shock from welding electrode or wiring can kill.

1.1 Wear dry insulating gloves. Do not touch electrode with bare hand. Do not wear wet or damaged gloves.

1.2 Protect yourself from electric shock by insulating yourself from work and ground.

1.3 Disconnect input plug or power before working on machine.

2 Breathing welding fumes can be hazardous to your health.

2.1 Keep your head out of the fumes.

2.2 Use forced ventilation or local exhaust to remove the fumes.

2.3 Use ventilating fan to remove fumes.

3 Welding sparks can cause explosion or fire.

3.1 Keep flammables away from welding. Do not weld near flammables.

3.2 Welding sparks can cause fires. Have a fire extinguisher nearby, and have a watchperson ready to use it.

3.3 Do not weld on drums or any closed containers.

4 Arc rays can burn eyes and injure skin.

4.1 Wear hat and safety glasses. Use ear protection and button shirt collar. Use welding helmet with correct shade of filter. Wear complete body protection.

5 Become trained and read the instructions before working on the machine or welding.

6 Do not remove or paint over (cover) the label.

1	1.1	1.2	1.3	4
2	2.1	2.2	2.3	4.1
3	3.1	3.2	3.3	5
6				

S-179 310-A

Warning! Watch Out! There are possible hazards as shown by the symbols.

- 1 Electric shock from wiring can kill.
- 2 Disconnect input plug or power before working on machine.
- 3 Hazardous voltage remains on input capacitors after power is turned off. Do not touch fully charged capacitors.
- 4 Always wait 60 seconds after power is turned off before working on unit, OR
- 5 Check input capacitor voltage, and be sure it is near 0 before touching any parts.
- 6 When power is applied failed parts can explode or cause other parts to explode.
- 7 Flying pieces of parts can cause injury. Always wear a face shield when servicing unit.
- 8 Always wear long sleeves and button your collar when servicing unit.
- 9 After taking proper precautions as shown, connect power to unit.

Warning! Watch Out! There are possible hazards as shown by the symbols.

- 1 Warning! Watch Out! There are possible hazards as shown by the symbols.
- 2 Falling equipment can cause injury and damage to unit.
- 3 Always lift and support unit using both handles. Keep angle of lifting device less than 60 degrees.
- 4 Use a proper cart to move unit.
- 5 Do not use one handle to lift or support unit.































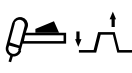
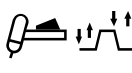
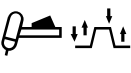



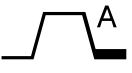

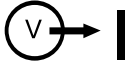
3-2. WEEE Label (For Products Sold Within The EU)

Do not discard product (where applicable) with general waste.

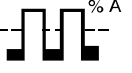
Reuse or recycle Waste Electrical and Electronic Equipment (WEEE) by disposing at a designated collection facility.

Contact your local recycling office or your local distributor for further information.

3-3. Symbols And Definitions

A Amperes	 Panel-Local	 Gas Tungsten Arc Welding (GTAW)	 Shielded Metal Arc Welding (SMAW)
V Volts	 Voltage Input	 3 Phase Static Frequency Converter-Transformer-Rectifier	
 Voltage Output	 Circuit Breaker	 Remote	 Lift-Arc Start (GTAW)
 Protective Earth (Ground)	 Postflow Timer	 Preflow Timer	S Seconds
I On	O Off	+ Positive	- Negative
 Alternating Current	 Gas Input	 Gas Output	I₂ Rated Welding Current
X Duty Cycle	 Direct Current	 Line Connection	U₂ Conventional Load Voltage
U₁ Primary Voltage	IP Degree Of Protection	I_{1max} Rated Maximum Supply Current	I_{1eff} Maximum Effective Supply Current
U₀ Rated No Load Voltage (Average)	 Pulse Background Amperage	 Initial Amperage	 Increase/Decrease Of Quantity
 Normal Trigger Operation (GTAW)	 Two-Step Trigger Operation (GTAW)	 Four-Step Trigger Operation (GTAW)	% Percent
Hz Hertz	 Recall From Memory	 Arc Force (DIG)	 HF Impulse Starting (GTAW)
 Final Slope	 Final Amperage	 Pulse Percent On Time	 Initial Slope
 Contactor Control (Stick)	 Pulser On-Off	 TIG Weld Amps And Peak Amps While Pulsing	 Pulse Frequency
 Background Amps	 Process	 Pulser	 Sequence
 Output	 Adjust	S Suitable For Areas Of Increased Shock Hazard	

SECTION 4 – INSTALLATION

4-1. Important Information Regarding CE Products (Sold Within The EU)

 **This equipment shall not be used by the general public as the EMF limits for the general public might be exceeded during welding.**

This equipment is built in accordance with EN 60974-1 and is intended to be used only in an occupational environment (where the general public access is prohibited or regulated in such a way as to be similar to occupational use) by an expert or an instructed person.

Wire feeders and ancillary equipment (such as torches, liquid cooling systems and arc striking and stabilizing devices) as part of the welding circuit may not be a major contributor to the EMF. See the Owner's Manuals for all components of the welding circuit for additional EMF exposure information.

- The EMF assessment on this equipment was conducted at 0.5 meter.
- At a distance of 1 meter the EMF exposure values were less than 20% of the permissible values.

4-2. Serial Number And Rating Label Location

The serial number and rating information for the power source is located on the rear of the machine. Use the rating labels to determine input power requirements and/or rated output. For future reference, write serial number in space provided on back cover of this manual.

4-3. Specifications

Input Power	Rated Output	Welding Amperage Range	Max. Open-Circuit Voltage (U ₀)	Rated Peak Striking Voltage (Up)	Amperes Input At Rated Output, 50/60Hz				KVA	KW
					115	230	400	460		
Three-Phase Stick Process	150 A @ 26 VDC, 60% Duty Cycle	1 – 200	80V 9-14◆	15 KV**	--	13.1 0.16*	7.4 0.24*	6.4 0.25*	5.2 0.06*	5.0 0.03*
Three-Phase TIG Process	175 A @ 17 VDC, 60% Duty Cycle	1 – 200	80 9-14◆	15 KV**	--	10.5 0.16*	6.0 0.24*	5.2 0.25*	4.2 0.06*	4.0 0.03*
Three-Phase Stick Process	200 A @ 28 VDC, 30% Duty Cycle	1 – 200	80V 9-14◆	15 KV**		18.4 0.16*	10.3 0.24*	8.9 0.25*	7.3 0.06*	7.0 0.03*
Three-Phase TIG Process	200 A @ 18 VDC, 40% Duty Cycle	1 – 200	80 9-14◆	15 KV**		12.7 0.16*	7.2 0.24*	6.2 0.25*	5.1 0.06*	4.9 0.03*
Single-Phase Stick Process	150 A @ 26 VDC, 60% Duty Cycle	1 – 200	80V 9-14◆	15 KV**	--	21.7 0.23*	--	10.6 .25*	5.0 0.05*	5.0 0.02*
Single-Phase TIG Process	175 A @ 17 VDC, 60% Duty Cycle	1 – 200	80 9-14◆	15 KV**	--	17.4 0.23*	--	8.5 .25*	4.0 0.05*	4.0 0.02*
Single-Phase Stick Process	125 A @ 25 VDC, 50% Duty Cycle	1 – 200	80V 9-14◆	15 KV**	34.1 0.42*	--	--	--	4.0 0.05*	3.8 0.03*
Single-Phase TIG Process	150 A @ 16 VDC, 70% Duty Cycle	1 – 200	80 9-14◆	15 KV**	29.7 0.42*	--	--	--	3.4 0.05*	3.4 0.03*
Single-Phase Stick Process	100 A @ 24 VDC, 80% Duty Cycle	1 – 200	80V 9-14◆	15 KV**	28.1 0.42*	--	--	--	3.2 0.05*	3.2 0.03*
Single-Phase TIG Process	125 A @ 15 VDC, 100% Duty Cycle	1 – 200	80 9-14◆	15 KV**	23.0 0.42*	--	--	--	2.6 0.05*	2.6 0.03*

*While idling

** Arc starting device is designed for manual guided operations.

◆ Low open-circuit voltage while in TIG Lift Arc™, or while in Stick with low open-circuit voltage selected.

▽ Normal open-circuit voltage (80 volts) is present while in Stick with normal open-circuit voltage selected.

☞ Duty cycle limitations on units with 115 volt input power are due to the input power cord supplied with the unit.

☞ This unit is equipped with Auto-Line™. The Auto-Line circuitry automatically connects to 120–460 VAC, single- or three-phase power without removing the cover to relink the power source.

4-4. Volt-Ampere Curves

Volt-ampere curves show minimum and maximum voltage and amperage output capabilities of welding power source. Curves of other settings fall between curves shown.

115VAC Input

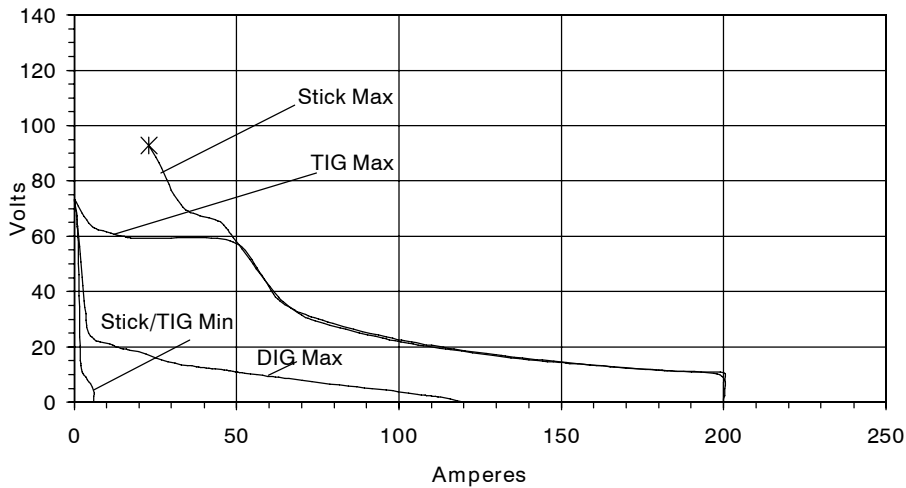

Other Input Voltages

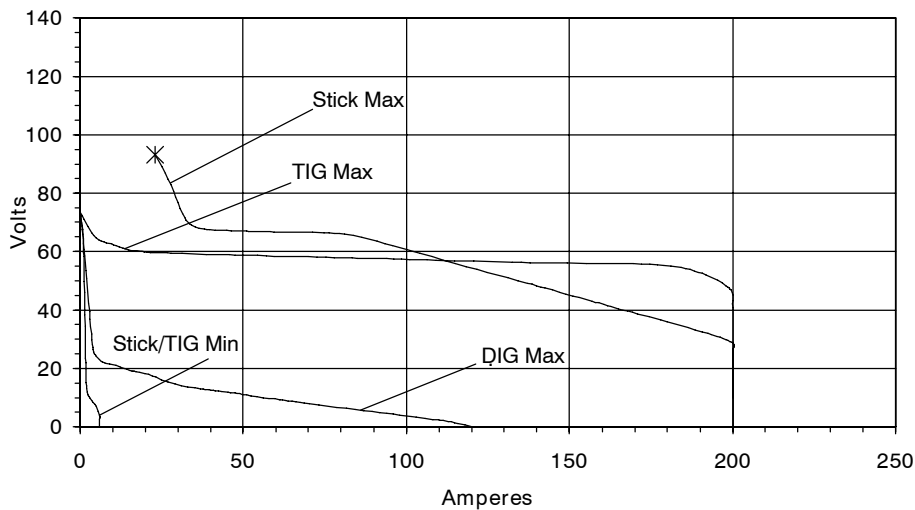

***Amperage setting must be reduced to obtain currents less than highlighted data* point.**

ST- 189 767-A

4-5. Duty Cycle And Overheating



MAXSTAR 200 DUTY CYCLE CHART

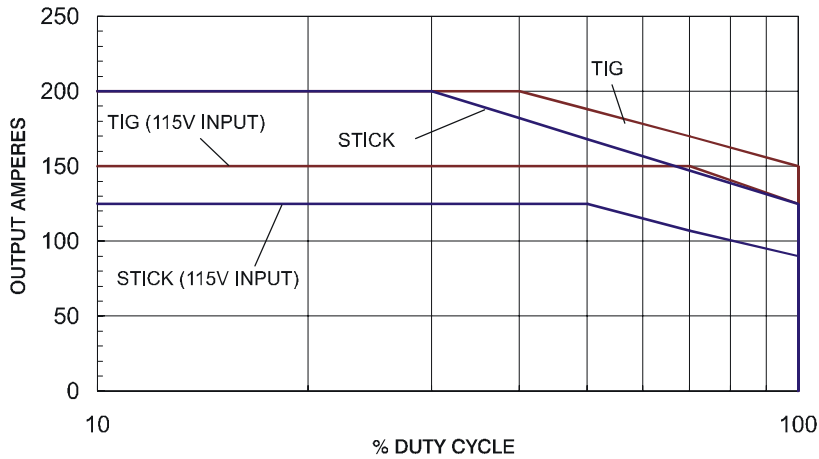

Duty Cycle is percentage of 10 minutes that unit can weld at rated load without overheating.

If unit overheats, output stops, a Help message is displayed (see Section 7-3), and cooling fan runs. Wait fifteen minutes for unit to cool. Reduce amperage or voltage, or duty cycle before welding.

NOTICE – Exceeding duty cycle can damage unit and void warranty.

90 A @ 100% Duty Cycle For 115 Volt Single-Phase Stick Process

125 A @ 100% Duty Cycle For 115 Volt Single-Phase TIG Process

150 A @ 60% Duty Cycle For Stick Process (Other Voltages)

175 A @ 60% Duty Cycle For TIG Process (Other Voltages)

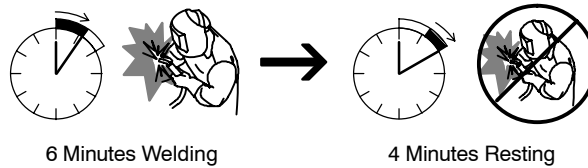

Overheating

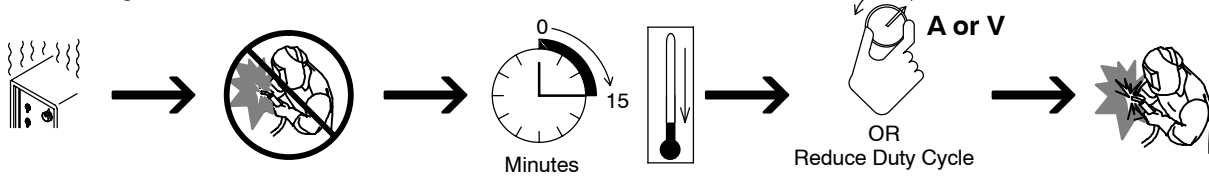

ST-189 770-A

4-6. Selecting A Location

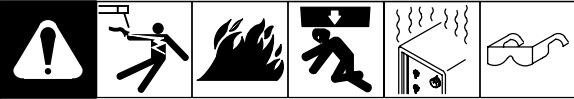

Dimensions And Weight

34.7 lb (15.7 kg) - without power cord

37.3 lb (16.9 kg) - with power cord

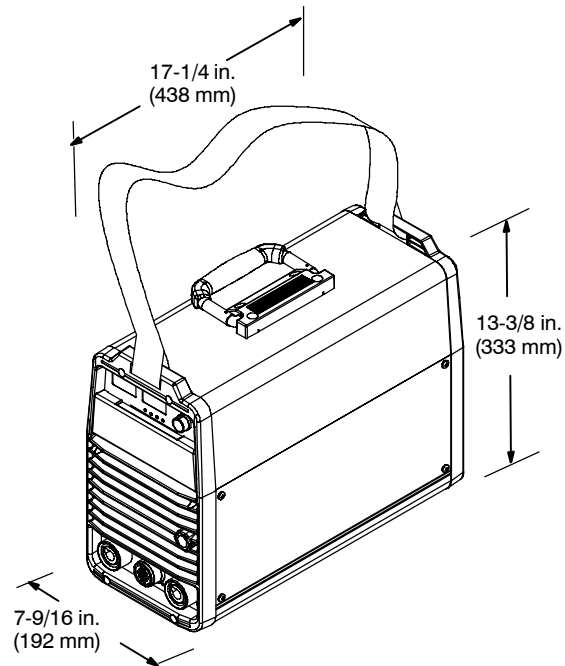

1 Line Disconnect Device

Locate unit near correct input power supply.

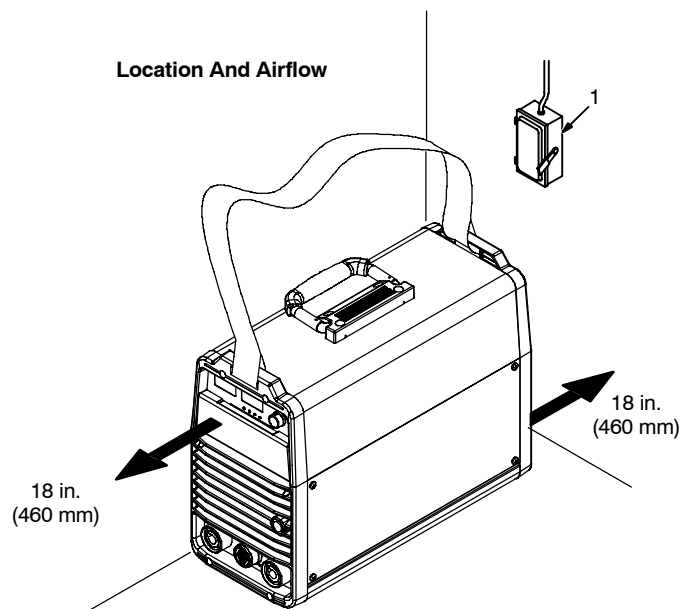

⚠ Special installation may be required where gasoline or volatile liquids are present – see NEC Article 511 or CEC Section 20.

Location And Airflow



4-7. Weld Output Terminals And Selecting Cable Sizes*

NOTICE – The Total Cable Length in Weld Circuit (see table below) is the combined length of both weld cables. For example, if the power source is 100 ft (30 m) from the workpiece, the total cable length in the weld circuit is 200 ft (2 cables x 100 ft). Use the 200 ft (60 m) column to determine cable size.

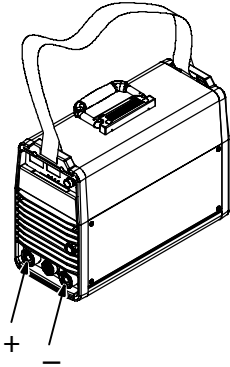
 Turn off power before connecting to weld output terminals.  Do not use worn, damaged, undersized, or poorly spliced cables.	Weld Cable Size** and Total Cable (Copper) Length in Weld Circuit Not Exceeding				
	100 ft (30 m) Or Less		150 ft (45 m)	200 ft (60 m)	
	Welding Amperes***	10 – 60% Duty Cycle	60 – 100% Duty Cycle	10 – 100% Duty Cycle	
 Output Receptacles	100	4 (20)	4 (20)	4 (20)	3 (30)
	150	3 (30)	3 (30)	2 (35)	1 (50)
	200	3 (30)	2 (35)	1 (50)	1/0 (60)

* This chart is a general guideline and may not suit all applications. If cable overheats, use next size larger cable.

**Weld cable size (AWG) is based on either a 4 volts or less drop or a current density of at least 300 circular mils per ampere.
 () = mm² for metric use

***Select weld cable size for pulsing application at peak amperage value.

For distances longer than those shown in this guide, call a factory applications rep. at 920-735-4505 (Miller) or 1-800-332-3281 (Hobart)

4-8. Remote 14 Receptacle Information

<p style="text-align: right;">ST-802 541</p>	REMOTE 14	Socket*	Socket Information
	15 VOLTS DC OUTPUT CONTACTOR	A	Contactactor control +15 volts DC.
	REMOTE OUTPUT CONTROL	B	Contact closure to A completes 15 volts DC contactor control circuit and enables output.
		C	Output to remote control; 0 to +10 volts DC output to remote control.
		D	Remote control circuit common.
	A/V AMPERAGE VOLTAGE	E	0 to +10 volts DC input command signal from remote control.
		F	Current feedback; +1 volt DC per 100 amperes.
GND	H	Voltage feedback; +1 volt DC per 10 volts output.	
	G	+15 volts DC GND	
CHASSIS	K	Chassis common.	
<p>* The remaining sockets are not used.</p> <p> If a remote hand control, like the RHC-14, is connected to the Remote 14 receptacle, some current value above min. must be set on the remote control before the Panel or Remote contactor is turned on. Failure to do so will cause current to be controlled by the panel control, and the remote hand control will not function.</p>			

4-9. Automation 10-Pin Connection (LX Models)

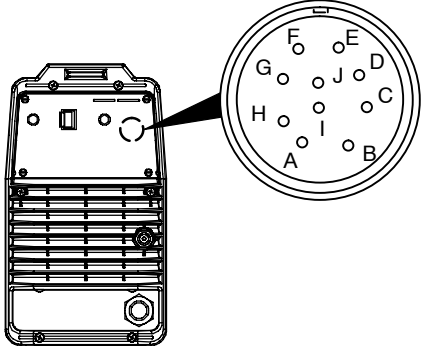
 Ref. ST-802 458	Socket	Socket Information For 10-Pin Receptacle RC2
	A	Start/Stop
	B	Gas
	C	Output enable
	D	Chassis ground
	E	Final slope – collector
	F	Final slope – emitter
	G	Pulse lockout – collector
	H	Pulse lockout – emitter
	I	Valid arc – collector
J	Valid arc – emitter	

Definitions Of Inputs And Outputs

Inputs

A - Closure to D starts the weld cycle. Opening closure stops weld cycle. During 2T operation, a momentary closure (greater than 100ms, but less than 3/4 seconds) starts and stops weld output.

B - Closure to D turns on gas. If a preflow time is entered, the preflow cycle will time out before arc initiation. If a post flow time is entered, the post flow cycle will time out at the end of the weld, even if B to D closure is opened.

C - Closure to D must be maintained at all times. If the closure between pins C and D is broken, an output disable occurs, Postflow begins to time out, and *HELP 13* will be displayed on the meters.

Outputs

Outputs are isolated open-collector transistor which are able to conduct at least 60 mA of current and 27 VDC peak.

Final Slope - output is on when in Final Slope.

Pulse Lockout - output is on when in Initial Amperage, Initial Slope, Final Slope, Final Amperage, during background time, and when the pulse frequency is less than 10 Hz.

Arc On - output is on when the contactor is on and amperage is greater than 5 amps, or output voltage is greater than 5 volts but less than 50 volts.

4-10. Typical Automation Application

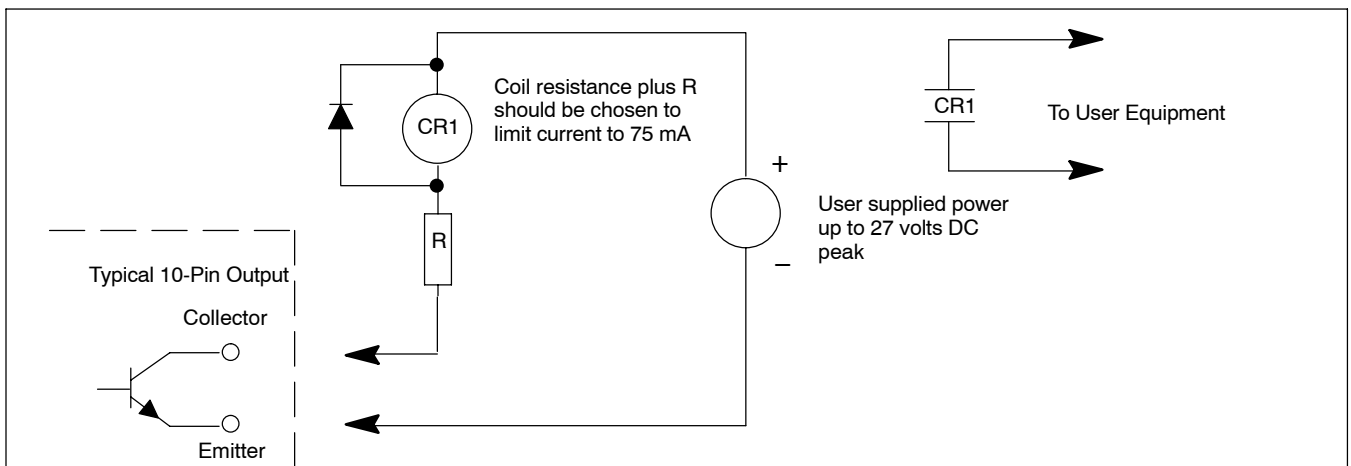

4-11. Gas Connections

1 Gas Fitting
Fittings have 5/8-18 right-hand threads (3/8-19 BSPP on CE units).

2 Cylinder Valve
Open valve slightly so gas flow blows dirt from valve. Close valve.

3 Regulator/Flowmeter

4 Flow Adjust
Typical flow rate is 15 cubic feet per hour (7.1 liters per minute).
Connect customer supplied gas hose between regulator/flowmeter and gas fitting on rear of unit.

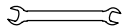
Tools Needed:

11/16, 1-1/8 in., (21 mm)

ST-802 452

4-12. TIG HF Impulse/ Lift-Arc DCEN (Direct Current Electrode Negative) Connections

⚠ Turn off power before making connections.

1 Negative (-) Weld Output Terminal
Connect TIG torch to negative weld output terminal.

2 Gas Out Connection
Connect torch gas hose to gas out fitting.

3 Positive (+) Weld Output Terminal
Connect work lead to positive weld output terminal.

4 Remote 14 Receptacle
Connect desired remote control to Remote 14 receptacle.

5 Gas In Connection
Connect gas hose from gas supply to gas in fitting.

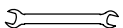
Tools Needed:

11/16 in., (21 mm)

Ref. ST-802 471

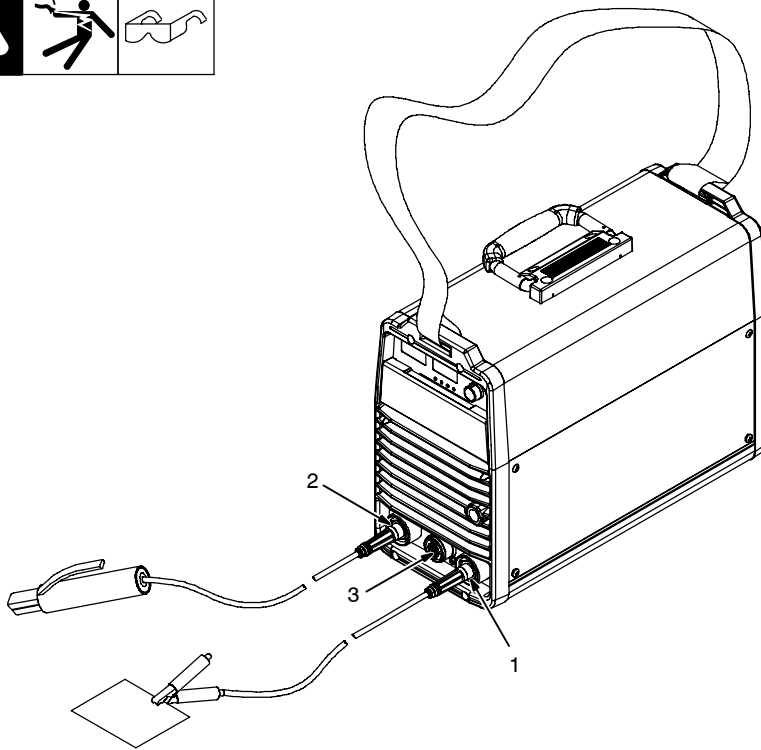
4-13. Stick DCEP (Direct Current Electrode Positive) Connections



⚠ Turn off power before making connections.

1 Negative (-) Weld Output Terminal

Connect work lead to negative weld output terminal.

2 Positive (+) Weld Output Terminal

Connect electrode holder to positive weld output terminal.

3 Remote 14 Receptacle

If desired, connect remote control to Remote 14 receptacle (see Section 4-8).

Ref. ST-802 471

4-14. TIGRunner Connections

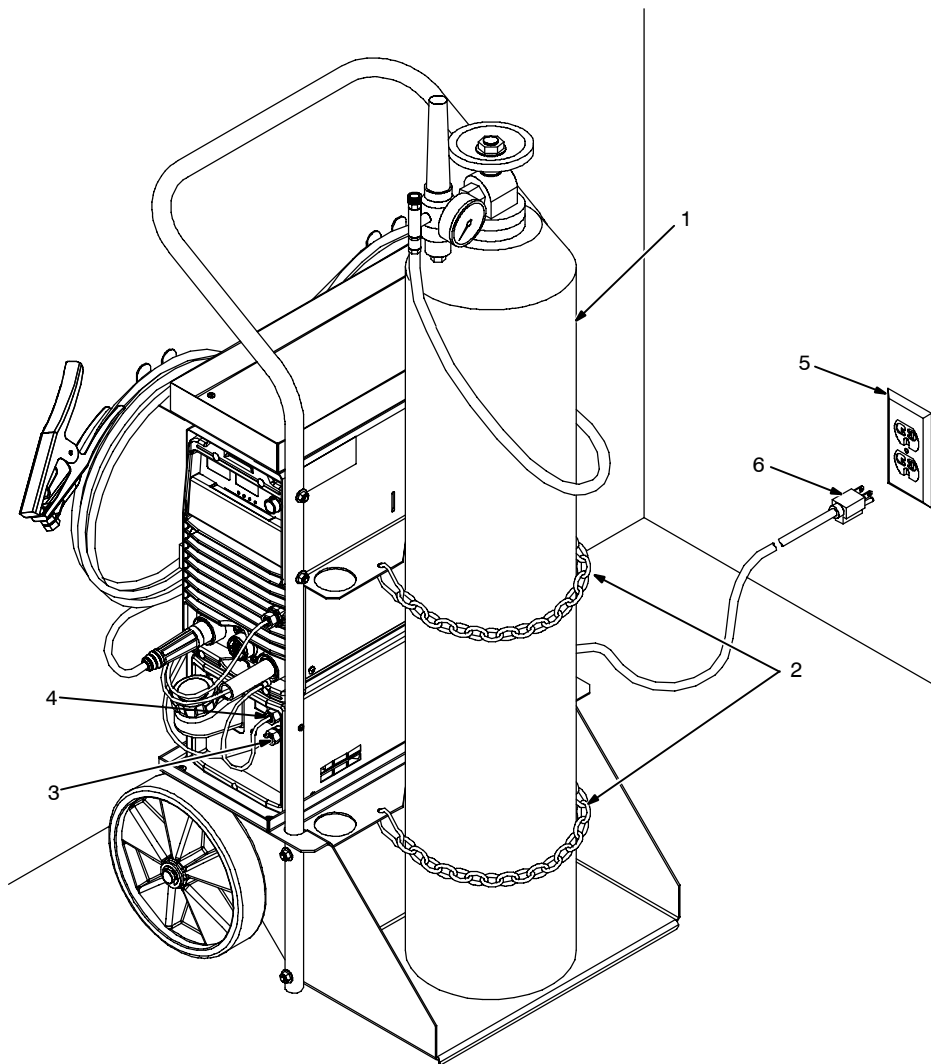

Cart and cooler are optional equipment.

- 1 Gas Cylinder
- 2 Chains

Secure gas cylinder to cart with chains.

Connect gas hose to welding power source (see Section 4-11).

Connect work lead and torch to welding power source (see Section 4-12).

- 3 Water-Out (To Torch) Connection

Connect torch water-in (blue) hose to welding power source water-out connection.

- 4 Water-In (From Torch) Connection

Connect torch water-out (red) hose to welding power source water-in connection.

- 5 115 Or 230 Volt AC Grounded Receptacle (Depending On Model)

For 115 volt models, an individual branch circuit capable of carrying 15 amperes and protected by fuses or circuit breakers is recommended. Recommended fuse or circuit breaker size is 15 amperes. For 230 volt models, an individual branch circuit capable of carrying 10 amperes and protected by fuses or circuit breakers is recommended. Recommended fuse or circuit breaker size is 10 amperes.

- 6 Power Cord

NOTICE – Do not cut plug from 115 volt cord and attempt to rewire for 230 volts, or do not cut plug from 230 volt cord and attempt to rewire for 115 volts.

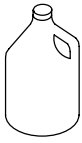
Application	GTAW Or Where HF* Is Used
 Coolant	Low Conductivity Coolant No. 043 810**; Distilled Or Deionized Water OK Above 32°F (0°C)

*HF: High Frequency Current

**Coolant 043 810, a 50/50 solution, protect to -37°F (-38°C) and resist algae growth.

NOTICE – Use of any coolant other than those listed in the table voids the warranty on any parts that come in contact with the coolant (pump, radiator, etc.).

Tools Needed:

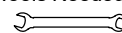

11/16 in., (21 mm for CE units)

4-15. Electrical Service Guide

 Actual input voltage should not fall below 103 volts AC or rise above 506 volts AC. If actual input voltage is outside this range, unit may not operate according to specifications.

 Failure to follow these electrical service guide recommendations could create an electric shock or fire hazard. These recommendations are for a dedicated branch circuit sized for the rated output and duty cycle of the welding power source.

Input Voltage (V)	Single-Phase, 100% Duty Cycle	Single-Phase, 60% Duty Cycle	Three-Phase, 60% Duty Cycle		
	115	230	230	400	460
Input Amperes (A) At Rated Output	25	22	13.1	7.4	6.4
Max Recommended Standard Fuse Rating In Amperes ¹					
Time Delay Fuses ²	25	25	15	8	8
Normal Operating Fuses ³	35	30	20	10	10
Min Input Conductor Size In AWG ⁴	10	12	14	14	14
Max Recommended Input Conductor Length In Feet (Meters)	57 (17)	79 (24)	102 (31)	308 (94)	407 (124)
Min Grounding Conductor Size In AWG ⁴	10	12	14	14	14

Reference: 2008 National Electrical Code (NEC) (including article 630)

1 If a circuit breaker is used in place of a fuse, choose a circuit breaker with time-current curves comparable to the recommended fuse.

2 "Time-Delay" fuses are UL class "RK5" . See UL 248.

3 "Normal Operating" (general purpose - no intentional delay) fuses are UL class "K5" (up to and including 60 amps), and UL class "H" (65 amps and above).

4 Conductor data in this section specifies conductor size (excluding flexible cord or cable) between the panelboard and the equipment per NEC Table 310.16. If a flexible cord or cable is used, minimum conductor size may increase. See NEC Table 400.5(A) for flexible cord and cable requirements.

4-16. Connecting Input Power



A. Connecting Three-Phase Input Power

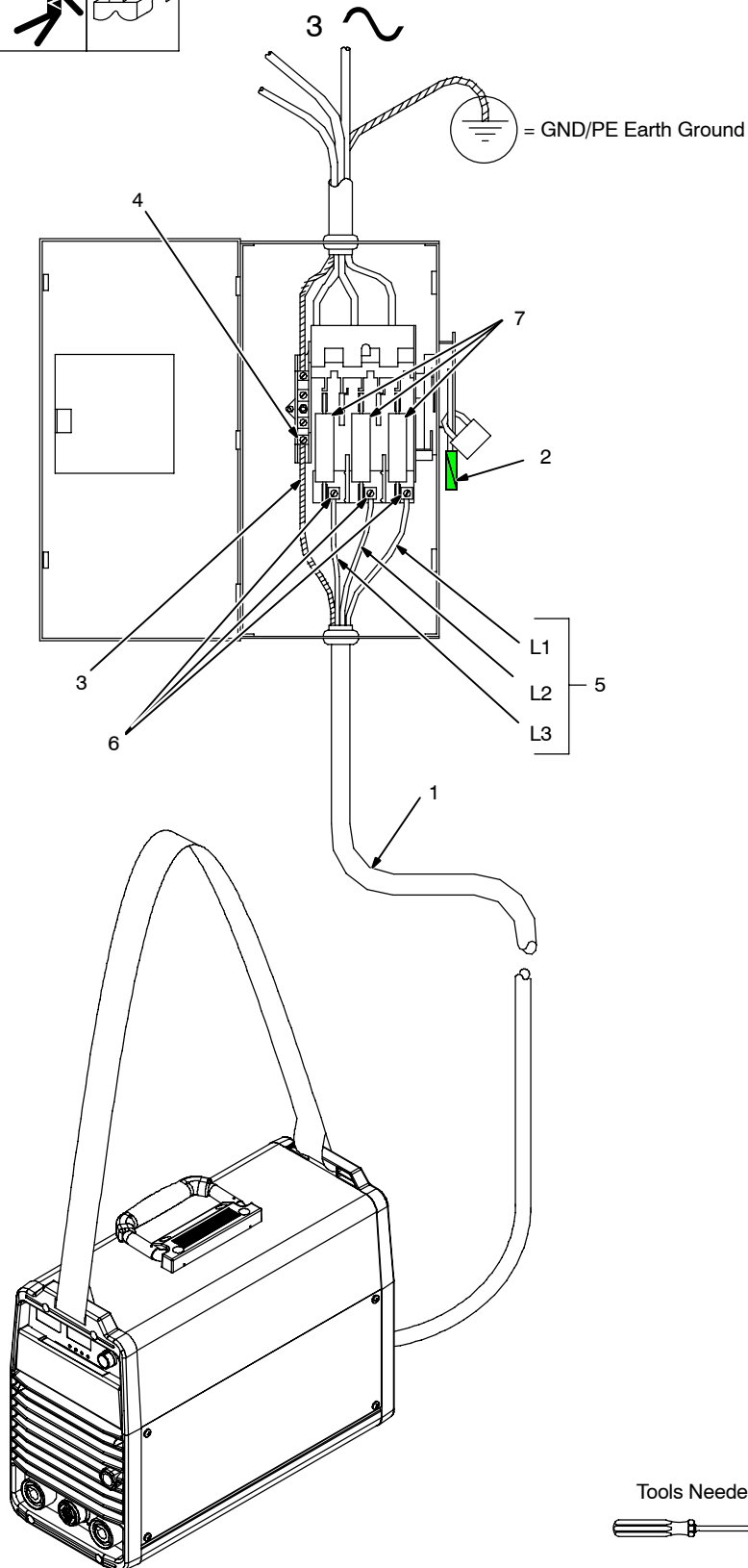

⚠ Installation must meet all National and Local Codes – have only qualified persons make this installation.

⚠ Disconnect and lockout/tagout input power before connecting input conductors from unit.

⚠ Always connect green or green/yellow conductor to supply grounding terminal first, and never to a line terminal.

☞ The Auto-Line circuitry in this unit automatically adapts the power source to the primary voltage being applied. Check input voltage available at site. This unit can be connected to any input power between 120 and 460 VAC without removing cover to relink the power source.

For Three-Phase Operation

- 1 Input Power Cord.
- 2 Disconnect Device (switch shown in the OFF position)
- 3 Green Or Green/Yellow Grounding Conductor
- 4 Disconnect Device Grounding Terminal
- 5 Input Conductors (L1, L2 And L3)
- 6 Disconnect Device Line Terminals

Connect green or green/yellow grounding conductor to disconnect device grounding terminal first.

Connect input conductors L1, L2, and L3 to disconnect device line terminals.

7 Over-Current Protection

Select type and size of over-current protection using Section 4-15 (fused disconnect switch shown).

Close and secure door on disconnect device. Remove lockout/tagout device, and place switch in the On position.

Tools Needed:



2/04 - Ref. 802 136-A

B. Connecting Single-Phase Input Power

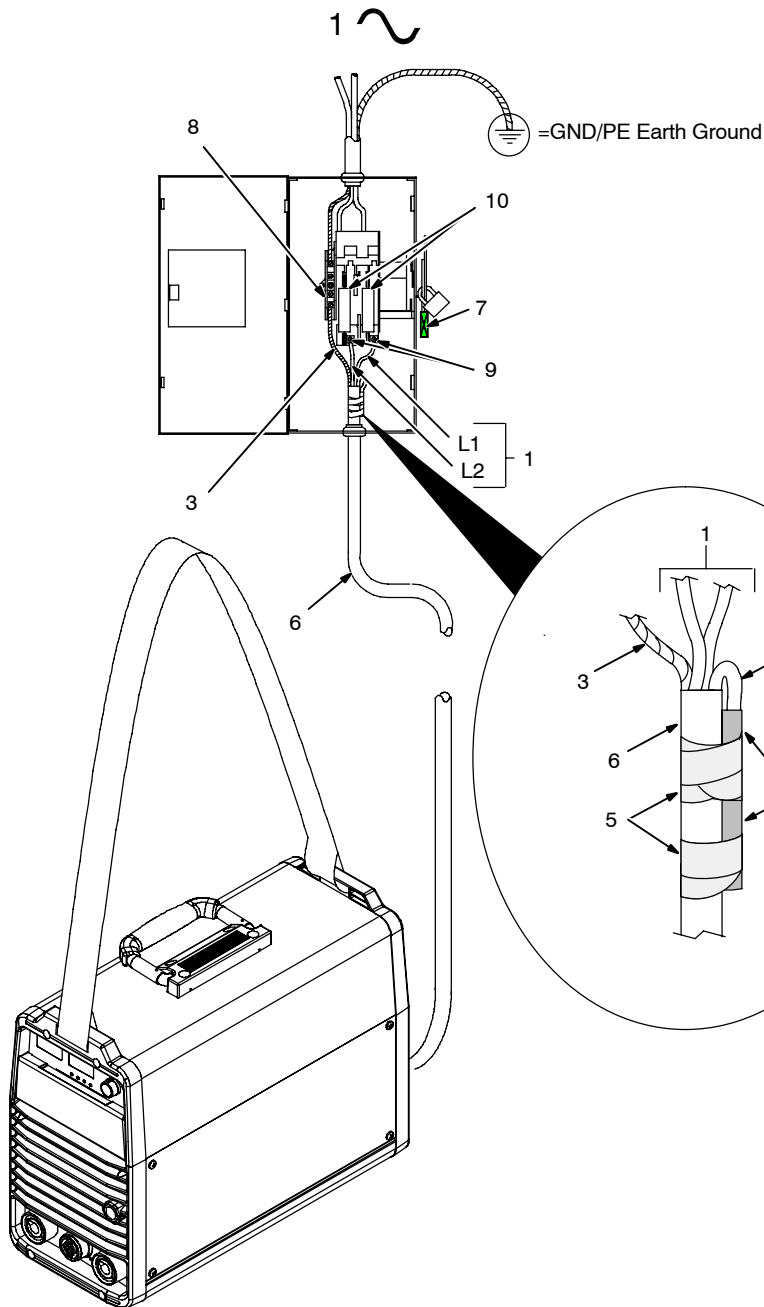

⚠ Installation must meet all National and Local Codes – have only qualified persons make this installation.

⚠ Disconnect and lockout/tagout input power before connecting input conductors from unit.

⚠ Always connect green or green/yellow conductor to supply grounding terminal first, and never to a line terminal.

ℹ The Auto-Line circuitry in this unit automatically adapts the power source to the primary voltage being applied. Check input voltage available at site. This unit can be connected to any input power between 120 and 460 VAC without removing cover to relink the power source.

- 1 Black And White Input Conductor (L1 And L2)
- 2 Red Input Conductor
- 3 Green Or Green/Yellow Grounding Conductor
- 4 Insulation Sleeve
- 5 Electrical Tape

Insulate and isolate red conductor as shown.

- 6 Input Power Cord.
- 7 Disconnect Device (switch shown in the OFF position)
- 8 Disconnect Device Grounding Terminal
- 9 Disconnect Device Line Terminals

Connect green or green/yellow grounding conductor to disconnect device grounding terminal first.

Connect input conductors L1 and L2 to disconnect device line terminals.

- 10 Over-Current Protection

Select type and size of over-current protection using Section 4-15 (fused disconnect switch shown).

Close and secure door on disconnect device. Remove lockout/tagout device, and place switch in the On position.

Tools Needed:



2/04 - Ref. 802 136-A

SECTION 5 – OPERATION

5-1. Controls

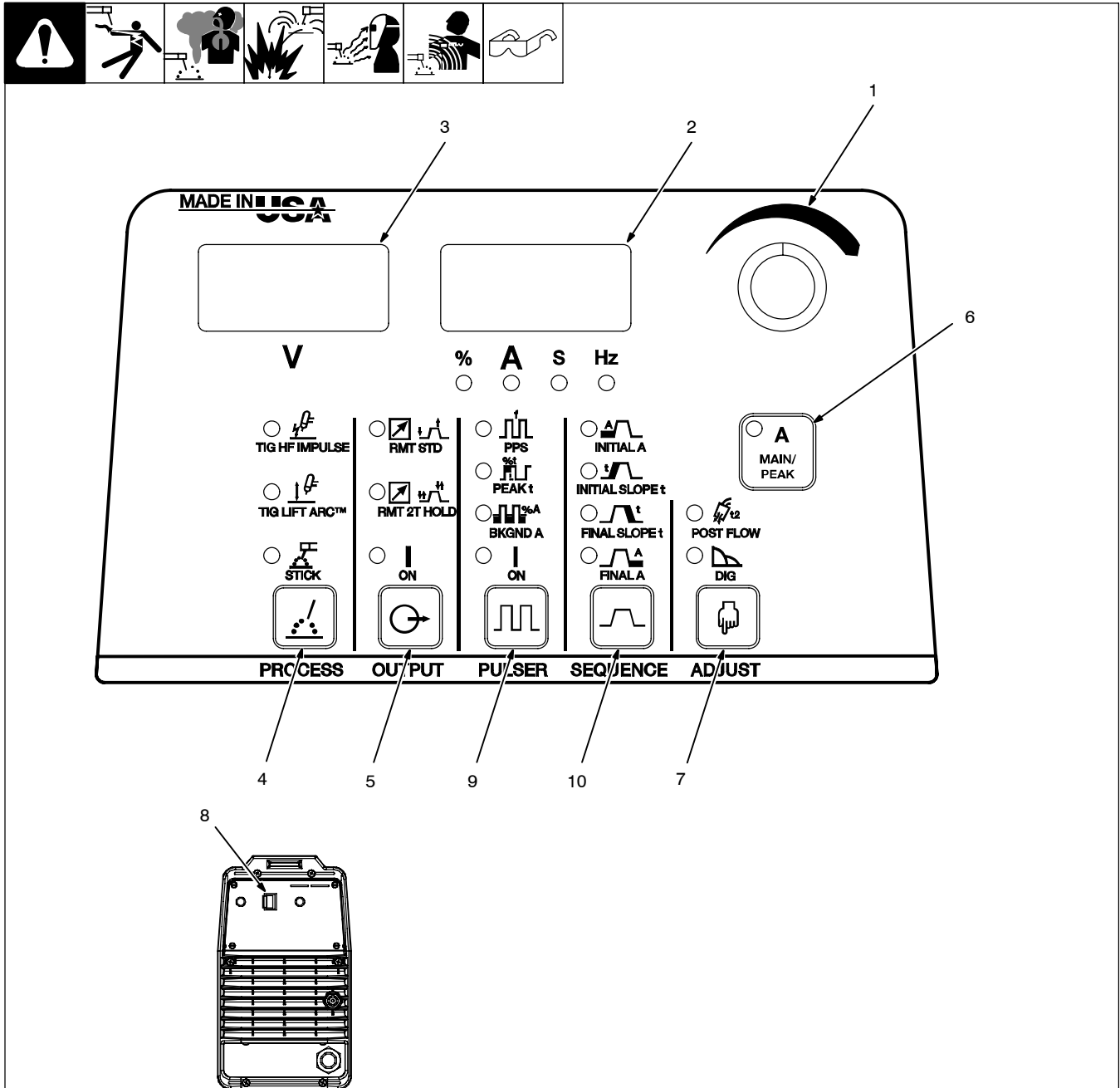

☞ For all front panel switch pad controls: press switch pad to turn on light and enable function.

☞ Green on nameplate indicates a TIG function, Gray indicates a Stick function.

1 Encoder Control

Use encoder control in conjunction with applicable front panel function switch pads to change values for that function. See Section 5-2.

2 Ammeter And Parameter Display

See Section 5-4.

3 Voltmeter

See Section 5-5.

4 Process Controls

See Section 5-6.

5 Output Controls

See Section 5-8.

6 Amperage And Spot Time Control

For Amperage control, see Section 5-3.

For Spot Time control, see Section 5-12.

7 Adjust Controls

See Section 5-11.

8 Power Switch

Use switch to turn unit On/Off.

9 Pulsar Controls (DX And LX Models)

See Section 5-9.

10 Sequencer Controls (DX, LX And All CE Models)

See Section 5-10.

5-2. Encoder Control

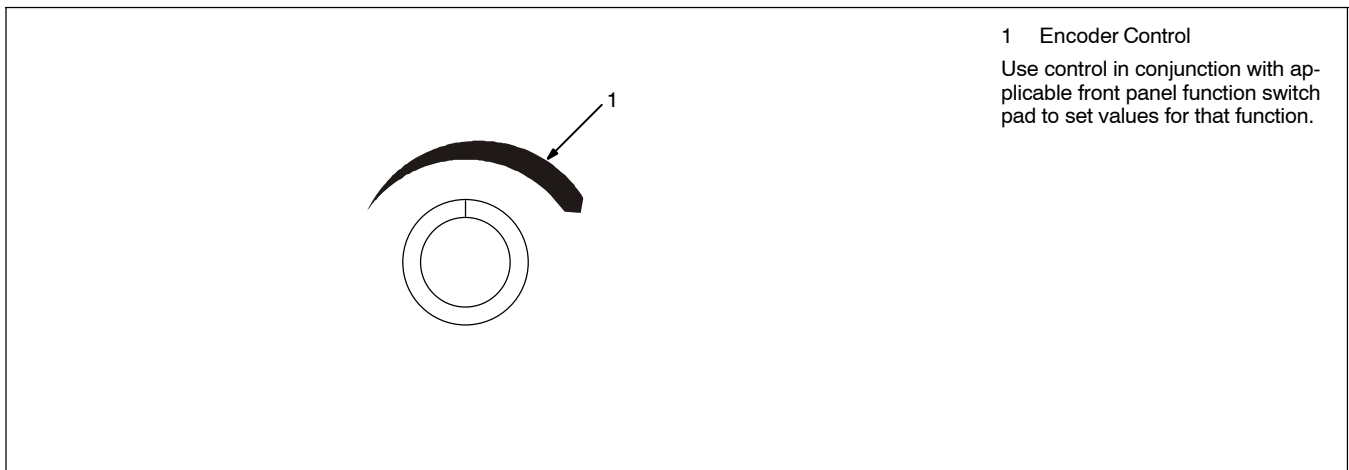

5-3. Amperage Control

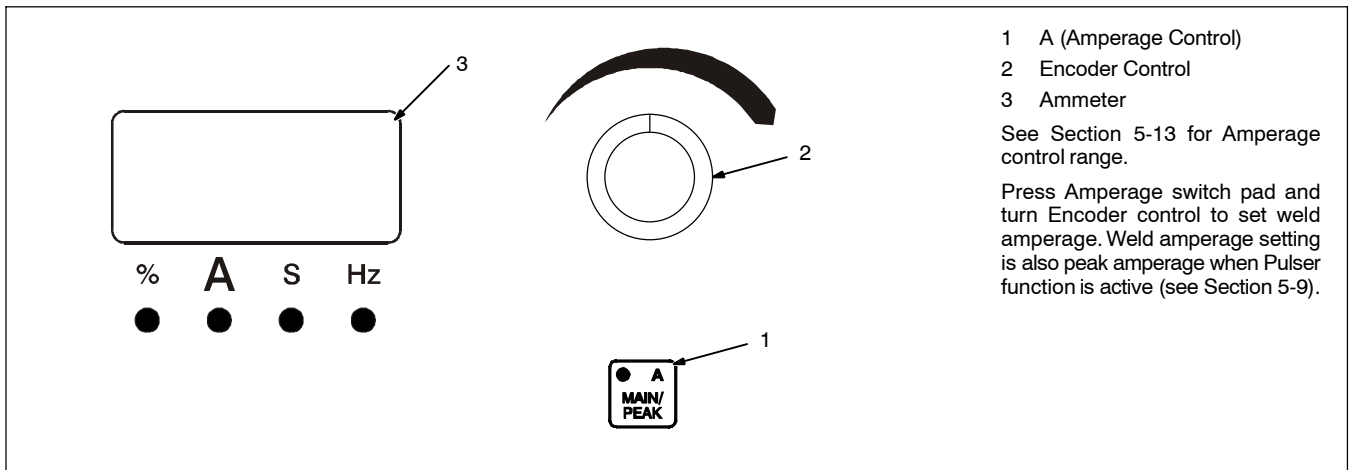

5-4. Ammeter And Parameter Display

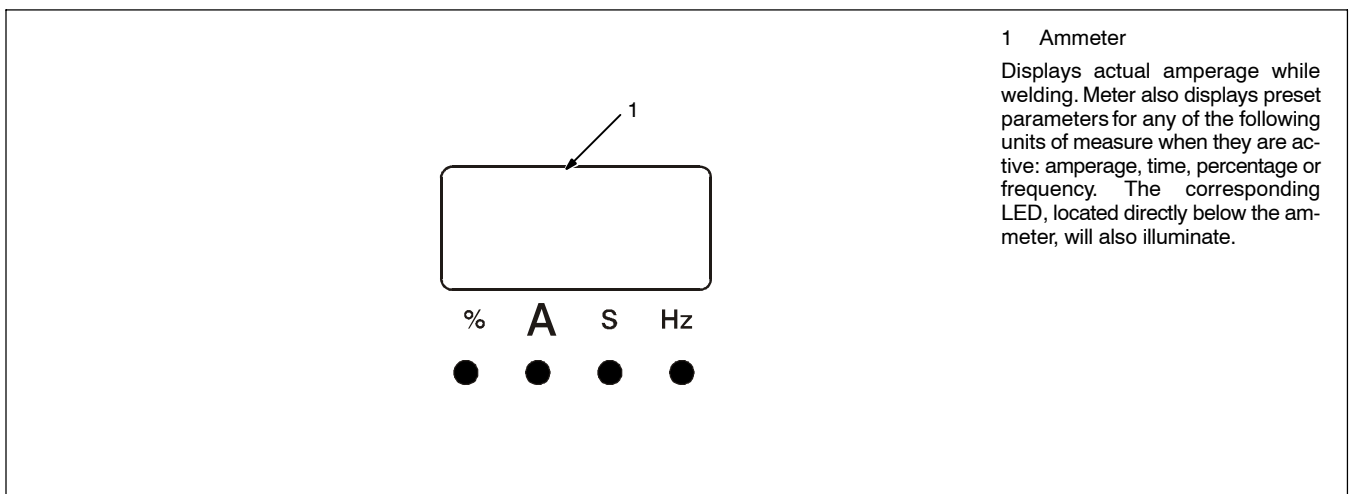

5-5. Voltmeter

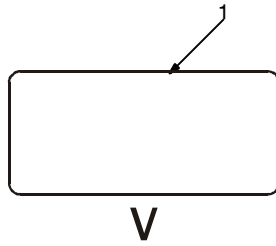

1 Volt Meter

Displays output or open circuit voltage. If output is off, the voltmeter will display a series of three dashes (---). Open circuit voltage is displayed if power is on and output is available.

5-6. Process Control

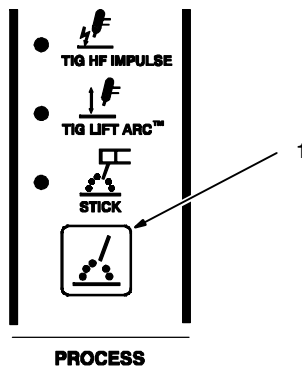

1 Process Control

Press switch pad until desired process LED is illuminated:

TIG HF Impulse - When selected, a pulsed HF (non-contact) (see Section 5-7) arc starting method is activated. This method can be used with either AC or DC TIG welding. Make connections according to Section 4-12.

TIG Lift-Arc™ - When selected, is an arc starting method in which the electrode must come in contact with the workpiece to initiate an arc (see Section 5-7). This method can be used with either AC or DC TIG welding. Make connections according to Section 4-12.

Stick (SMAW) - This method can be used with either AC or DC Stick welding. Make connections according to Section 4-13.

5-7. Lift-Arc™ And HF TIG Start Procedures

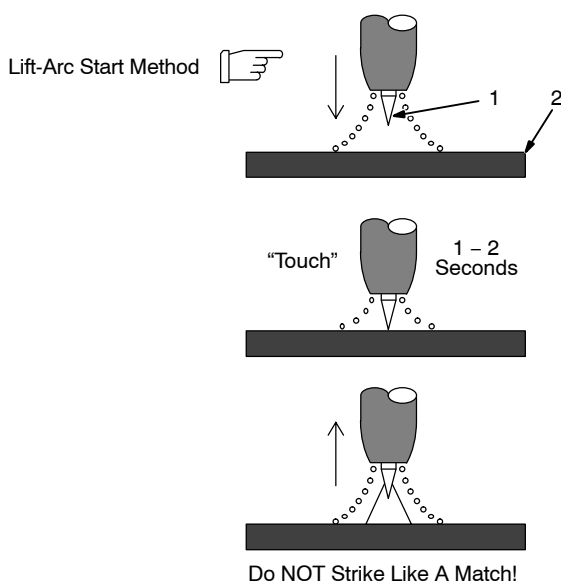

Lift-Arc Start

When Lift-Arc™ button light is On, start arc as follows:

- 1 TIG Electrode
- 2 Workpiece

Touch tungsten electrode to workpiece at weld start point, enable output and shielding gas with torch trigger, foot control, or hand control. **Hold electrode to workpiece for 1-2 seconds**, and slowly lift electrode. Arc is formed when electrode is lifted.

Normal open-circuit voltage is not present before tungsten electrode touches workpiece; only a low sensing voltage is present between electrode and workpiece. The solid-state output contactor does not energize until after electrode is touching workpiece. This allows electrode to touch workpiece without overheating, sticking, or getting contaminated.

Application:

Lift-Arc is used for the DCEN or AC GTAW process when HF Start method is not permitted, or to replace the scratch method.

HF Start

When HF Start button light is On, start arc as follows:

High frequency turns on to help start arc when output is enabled. High frequency turns off when arc is started, and turns on whenever arc is broken to help restart arc.

Application:

HF start is used for the DCEN GTAW process when a non-contact arc starting method is required.

5-8. Output Control

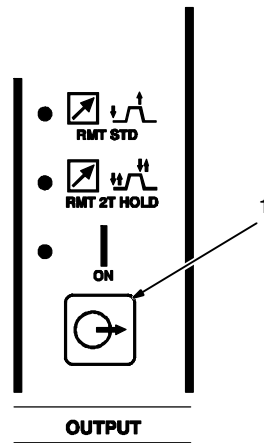

1 Output Control

Press switch pad until desired parameter LED is illuminated.

RMT STD (Remote Standard)

Application: Use Remote Trigger (Standard) when the operator desires to use a foot pedal or finger amperage control (see Section 6-3A).

When a foot or finger remote current control is connected to the welding power source, initial amps, initial slope, final slope, and final amps are

controlled at the remote control, not at the welding power source.

If On/Off only type trigger is used, it must be a maintained switch. All Sequencer functions become active, and must be set by the operator.

RMT 2T HOLD

Application: Use Remote Trigger Hold (2T) when long extended welds are made. Remote Trigger Hold (2T) can help to reduce operator fatigue.

If a foot or finger current control is connected to the welding power source, only

trigger input is functional (see Section 6-3B).

This switch function can be reconfigured for 4T, 4T Momentary, Mini Logic, or Spot control See Section 6-3)

ON

Output will energize two seconds after being selected.

Application: Use Output On for Stick (SMAW) welding, or for Lift-Arc without the use of a remote control (see Section 6-3H).

5-9. Pulsar Control (DX And LX Models)

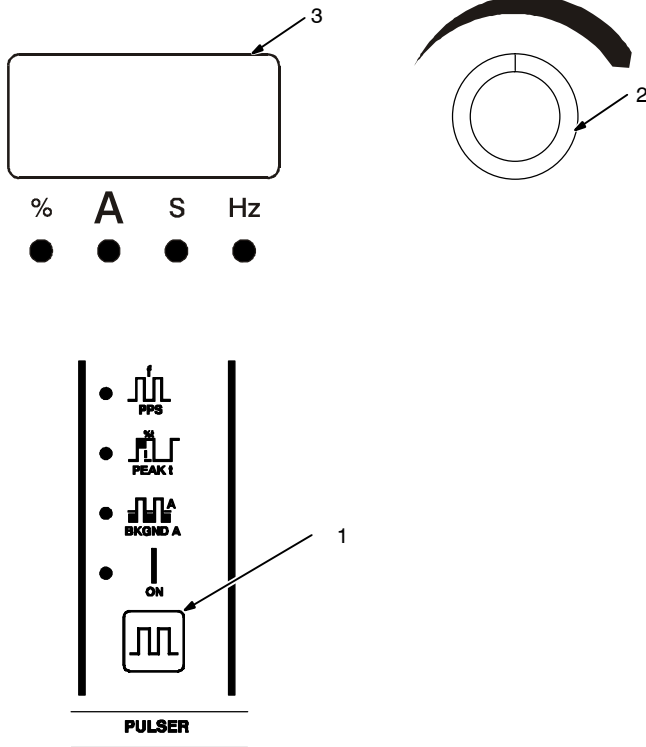

Percent (%) Peak Time Control Setting	Pulsed Output Waveforms
Balanced (50%)	
More Time At Peak Amperage (80%)	
More Time At Background Amperage (20%)	

1 Pulsar Control

Pulsing is available only while using the TIG process, it cannot be selected if the Stick process (see Section 5-6) is active. Controls can be adjusted while welding.

Press switch pad to enable pulser.

ON - When illuminated, this LED indicates the pulser is on.

Press switch pad until desired parameter LED is illuminated.

To turn Pulsar off, press and release switch pad until the On LED turns off.

2 Encoder Control

3 Ammeter

Turn encoder (see Section 5-2) to select appropriate value for active pulse parameter. Value selected is shown on the ammeter (see Section 5-4). Also, the ammeter LED for the corresponding unit of measure (% , A , s , Hz) of the active parameter will be illuminated.

See Section 5-13 for all Pulsar parameter ranges.

PPS (Pulses Per Second or Pulse Frequency) - Control is used to determine appearance of weld bead.

PEAK t - The percentage of each pulse cycle that can be spent at the peak amperage level.

BKGND A (Background Amps) - Use Background Amps control to set the low pulse of the weld amperage, which cools the weld puddle and affects overall heat input. Background Amps is set as a percentage of peak amperage.

4 Pulsed Output Waveforms

Example shows affect changing the Peak Time control has on the pulsed output waveform.

 *Peak amperage is set using the Amperage control (see Section 5-3). Peak amperage is the highest welding amperage allowed to occur in the pulse cycle. Weld penetration varies directly with peak amperage.*

Application:

Pulsing refers to the alternating raising and lowering of the weld output at a specific rate. The raised portions of the weld output are controlled in width, height, and frequency, forming pulses of weld output. These pulses and the lower amperage level between them (called the background amperage) alternately heat and cool the molten weld puddle. The combined effect gives the operator better control of penetration, bead width, crowning, undercutting, and heat input. Controls can be adjusted while welding.

Pulsing can also be used for filler material addition technique training.

5-10. Sequencer Controls (DX Models Only)

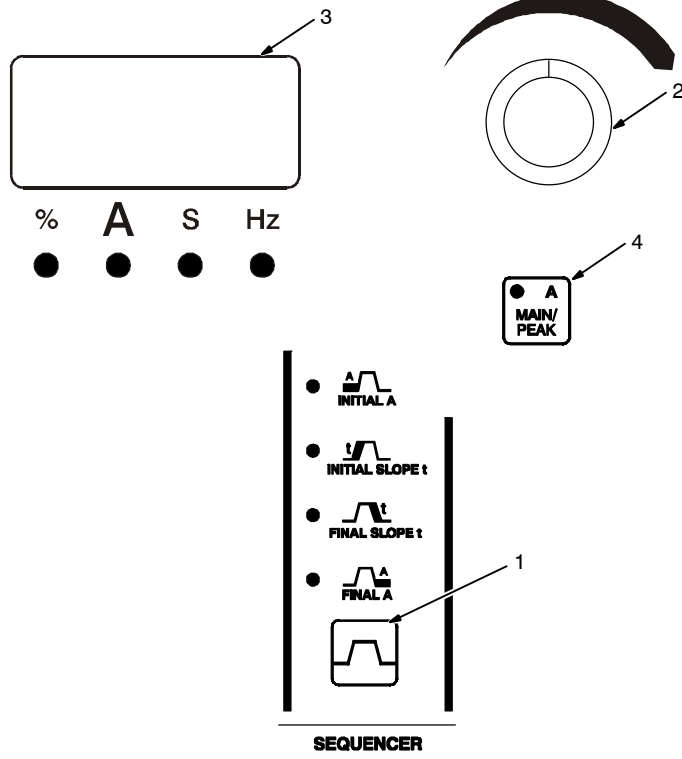

1 Sequencer Control

Sequencing is available only while using the TIG process, but is disabled if a remote foot or finger current control is connected to the Remote receptacle while in the RMT STD mode. Sequencer parameters cannot be selected if the Stick process (see Section 5-6) is active.

Press switch pad until desired parameter LED is illuminated.

2 Encoder Control

3 Ammeter

Turn encoder (see Section 5-2) to set appropriate value for active sequence parameter. Value selected is shown on the ammeter (see Section 5-4). Also, the ammeter LED for the corresponding unit of measure (A, S) of the active parameter will be illuminated.

See Section 5-13 for all Sequencer parameter ranges.

INITIAL A (Initial Amperage) - Use control to select a starting amperage that is different from the weld amperage.

Application:

Initial Amperage can be used while GTAW welding to assist in preheating cold material prior to depositing filler material, or to ensure a soft start.

INITIAL t (Initial Time)(LX Models Only) - Press control again and turn Encoder to select amount of time that is needed at the beginning of the weld.

INITIAL SLOPE t (Initial Slope Time) Use control to select amount of time that it takes to slope up/down from initial amperage to weld amperage. To disable, set to 0.

4 Amperage Switch Pad

Weld Time (LX Models Only) - Press Amperage switch pad twice. Set desired length of weld time.

FINAL SLOPE t (Final Slope Time) - Use control to select amount of time that it takes to slope up/down from weld amperage to final amperage. To disable, set to 0.

Application:

Final Slope should be used while GTAW welding materials that are crack sensitive, and/or the operator wants to eliminate the crater at the end of the weld.

FINAL A (Final Amperage) - Use control to select amperage to which weld amperage has sloped up/down to.

FINAL t (Final Time)(LX Models Only) - Press control again and turn Encoder to select amount of time that is needed at the end of the weld.

5-11. Adjust Controls (Preflow/Post Flow/DIG/Purge)

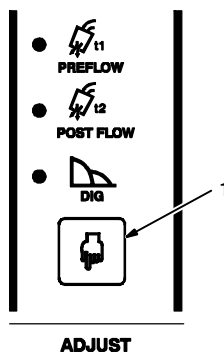
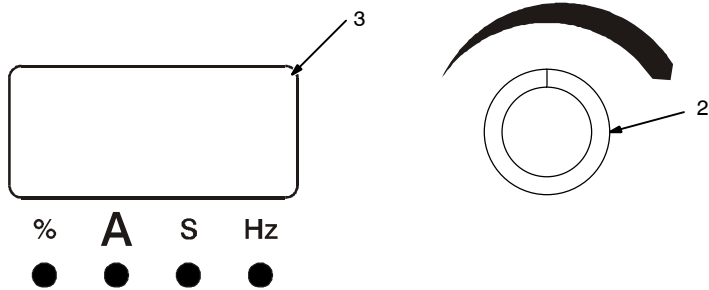

1 Adjust

Press switch pad until desired function LED is illuminated.

2 Encoder Control

3 Ammeter

Turn encoder (see Section 5-2) to set appropriate value for active Adjust parameter. Value selected is shown on the ammeter (see Section 5-4). Also, the ammeter LED for the corresponding unit of measure (S, %) of the active parameter will be illuminated.

See Section 5-13 for all Adjust parameter ranges.

PREFLOW - If the TIG HF process is active (see Section 5-6) and Preflow is shown on the control panel, use control to set length of time gas flows before arc initiation. To set Preflow time for models that do not have Preflow Time control on the front panel, see Section 6-1.

Application: Preflow is used to purge the immediate weld area of atmosphere. Preflow also aids in consistent arc starts.

POST FLOW - If the TIG process is active (see Section 5-6), use control to set length of time gas flows after welding stops.

Application:

Postflow is required to cool tungsten and weld, and to prevent contamination of tungsten and weld. Increase postflow time if tungsten or weld are dark in appearance.

DIG - If the Stick process is active (see Section 5-6), use control to set amount of DIG. When set at 0, short-circuit amperage at low arc voltage is the same as normal welding amperage.

When setting is increased, short-circuit amperage at low arc voltage increases.

Application:

Control helps arc starting or making vertical or overhead welds by increasing amperage at low arc voltage, and reduces electrode sticking while welding.

PURGE - While in the TIG process (see Section 5-6), to activate the gas valve and start the purge function, push and hold the Adjust switch pad for the desired amount of purge time. To set from 0 to 50 seconds of additional purge time, continue to hold the Adjust switch pad while turning the encoder control. Factory default setting is 0.

While Purge is active, [PUR] is shown in the left display, and purge time is shown in the right display.

Pressing any front panel switch pad will end the purge time display, but gas will continue to flow until the preset time has timed out.

Application: Purge is used to clear the shielding gas lines of contaminants.

5-12. Spot Time Control (Reconfigured RMT 2T HOLD Output Selection)

1 Spot Time Meter Display
Select Spot function according to Section 6-3G.

2 Amperage Switch Pad

3 Encoder Control

Set spot parameters as follows: Press Amperage switch pad once (meter A LED turns on) and turn Encoder to set spot amperage. Press Amperage switch pad again, (meter S LED lights) and turn Encoder to set spot time (.1–25 seconds). Factory default setting is 1 second.

Application: To provide a timed weld. Used for tacking, and thin sheet joining.

5-13. Factory Parameter Defaults And Range And Resolution

Parameter	Default	Range And Resolution
PROCESS	TIG HF Impulse	TIG HF Impulse / TIG Lift / Stick
* Stick OCV	Low OCV	Low OCV / Normal OCV
*Stick Stuck Check	Sc1 (On)	Sc1 (On) / Sc0 (Off)
OUTPUT	RMT STD	RMT STD / RMT 2T / ON
RMT 2T ¹	2T	RMT 2T can be reconfigured for: 2T / 4T / Mini Logic / 4T Momentary / Spot (see Section 6-3)
A MAIN / PEAK		
DC TIG	150 A	1 – 200 Amps
DC STICK	110 A	1 – 200 Amps
Spot Time	1.0 S	0.1 – 25.0 Seconds
**Weld Time	0 S	Dual Range And Resolution 0.0 – 99.9 / 100 – 999 Seconds
PULSER	Off	ON / OFF
PPS	100 Hz	Dual Range And Resolution 0.1 – 9.9 / 10 – 500 Hertz
PEAK t	40%	5 – 95 Percent
BKGND A	25%	5 – 95 Percent
*Meter “PPP” Display	--- (Off)	--- (Off) / PPPP (On)
SEQUENCER		
INITIAL A	20 A	1 – 200 Amps
**Initial Time	0 S	0.0 – 25.0 Seconds
INITIAL SLOPE t	0 S	0.0 – 25.0 Seconds
FINAL SLOPE t	0 S	0.0 – 25.0 Seconds
FINAL A	5 A	1 – 200 Amps
**Final Time	0 S	0.0 – 25.0 Seconds

ADJUST *PREFLOW POST FLOW DIG	0.2 S 10.0 S 30%	0.0 – 25.0 Seconds 0.0 – 50.0 Seconds @ 0.2 Second Resolution 0 – 100 Percent
MAXSTAR: *Tungsten ***Amperage ***Time ***Start Slope Time ***Preset Amperage Minimum	 .094 60 1 40 3	 GEN, .020, .040, .062, .094, .125 1 – 200 Amps 1 – 200 Milliseconds 0 – 250 Milliseconds 1 – 20 Amps

* Parameter adjusted using an Advanced Functions configuration only (see Section 6).

** Parameter used with the automation option (LX models only).

***Parameter adjust using Tungsten GEN only.

5-14. Resetting Unit To Factory Default Settings (All Models)

The diagram illustrates the control panel of a welding power source. At the top, there are two digital displays for voltage (V) and amperage (% A S Hz), and a rotary knob. Below these are five columns of controls: PROCESS, OUTPUT, PULSE, FREQUENCY, and ADJUST. Each column contains several icons and labels for various welding parameters. A hand is shown pressing the 'ADJUST' switch pad (labeled 3). Below the main panel, a circular inset labeled 'Rear Panel' shows a hand pressing the 'Power Switch' (labeled 4).

- 1 Process Switch Pad
- 2 Output Switch Pad
- 3 Adjust Switch Pad
- 4 Power Switch

To reset all welding power source functions to original factory settings, lockout feature must be off (see Section 6-7). Next turn power on, then press the Process, Output, and Adjust switch pads before the software version clears the meters, and hold the switch pads until software version clears the meters.

5-15. Arc Timer/Counter Display

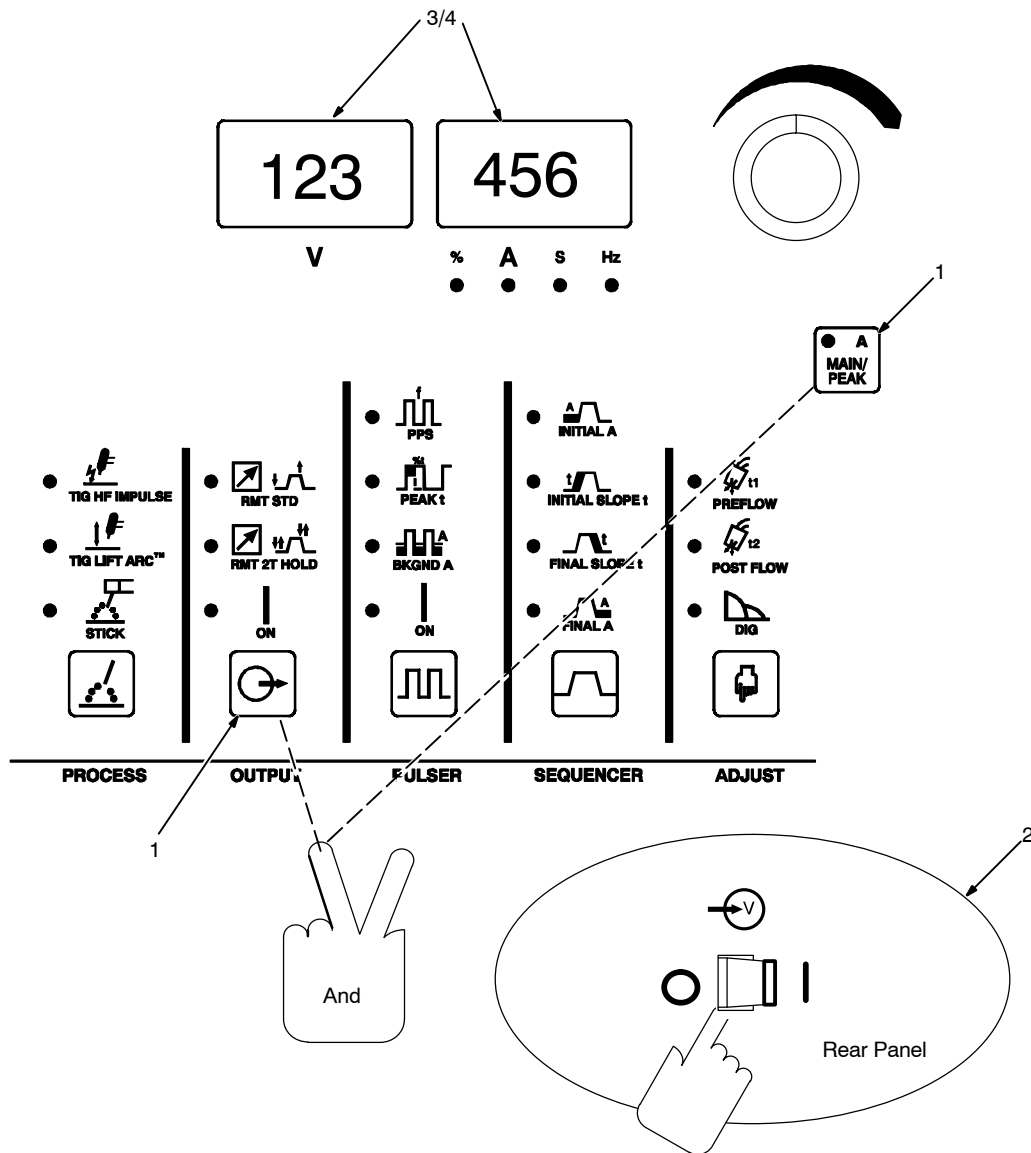

1 Output And Amperage Controls

2 Power Switch

To display the arc timer/counter, turn power switch on, and then press the Amperage Control and Output switch pads before the software version clears the meters, and hold the switch pads until software version clears the meters

3 Arc Timer Display

Upon power up as described above, the meter S LED will turn on, and arc time will be displayed for 5 seconds as [000 000] to [999 999]. The first four numbers indicate hours, and the last two numbers indicate minutes. Arc time shown in example is read as 1,234 hours and 56 minutes. Maximum arc time is 9,999 hours and 59 minutes.

4 Arc Counter

After 5 seconds, the meter A LED turns on, and the arc counter will be displayed for the next 5 seconds as [000 000] to [999 999]. The maximum arc cycle count is 999 999.

SECTION 6 – ADVANCED FUNCTIONS



6-1. Accessing Advanced Functions

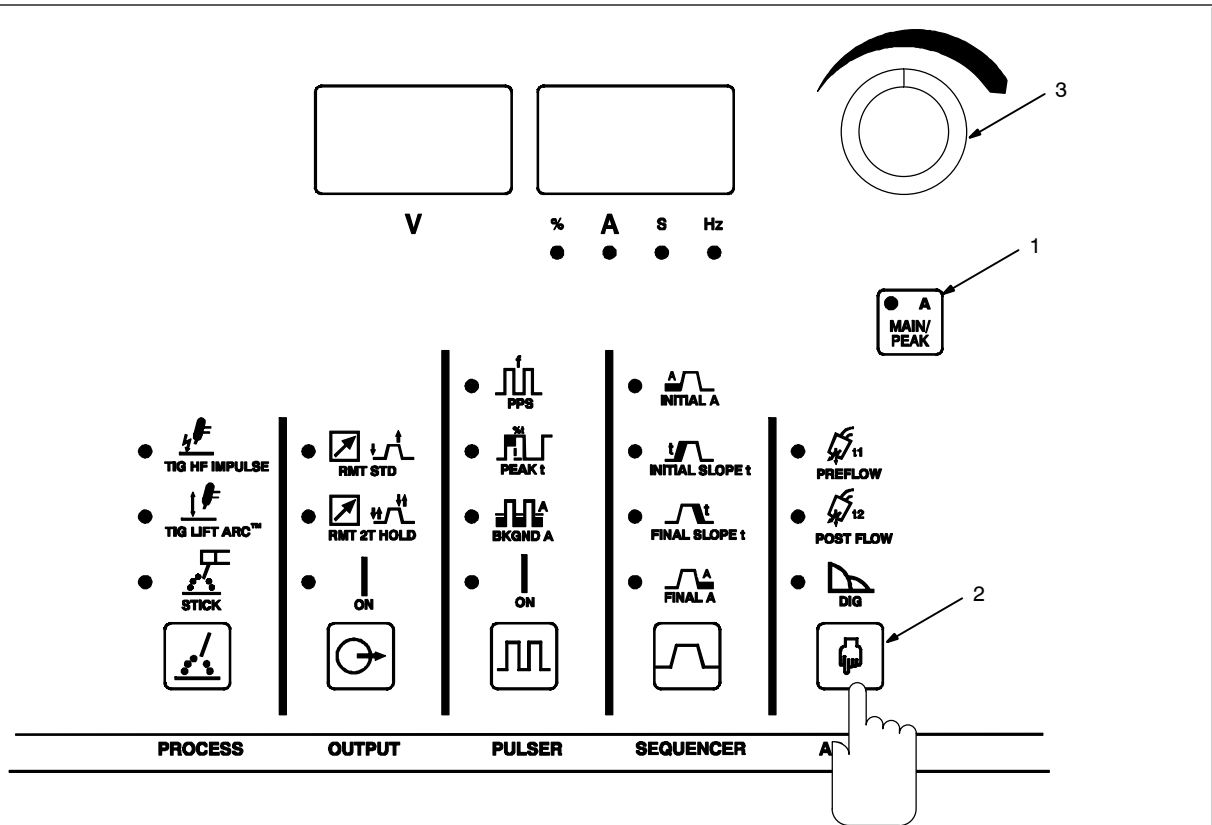

- 1 Amperage Switch Pad
- 2 Adjust
- 3 Encoder Control

To access the advanced functions, press and hold the Amperage (A) switch pad and then press the Adjust switch pad. To scroll through the advanced functions, press and release the Adjust switch pad. Use the Encoder control to change parameters for each function.

Advanced Functions:

- Programmable TIG Start Parameters (see Section 6-2) – Allows you to set amps, time, and polarity to customize arc

starts for different tungstens.

- Output Remote Hold And Trigger Functions (see Section 6-3) – For reconfiguring RMT 2T Hold for 3T, 4T Momentary, or Mini Logic
- Preflow Time (see Section 6-4) – Sets the gas flow time before TIG arc starts.
- Stick OCV Selection (see Section 6-5) – Allows you to select either low or normal OCV (open circuit voltage).
- Stick Stuck Check Selection (See Section 6-6) – With Stick Stuck Check on and the welding electrode (rod) stuck, output

is turned off in an attempt to save the rod for reuse.

- Lockout Functions (see Section 6-7) – Allows you to turn the lockout function on and off and adjust the lockout levels.
- Meter Displays (see Section 6-8) – Allows you to set meters to display weld voltage and amperage, or blank meters while pulse welding.
- External Pulse Control (see Section 6-9) – Used for external pulse control when external pulse control is desired.

To exit advanced functions, press and hold the Amperage (A) switch pad and then press the Adjust switch pad.

6-2. Programmable TIG Start Parameters

A. Tungsten Selection

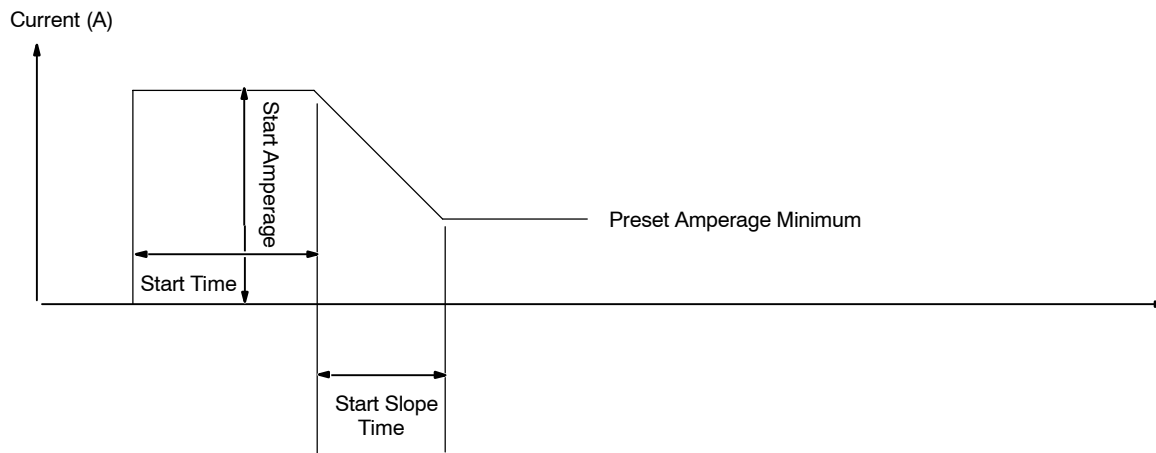
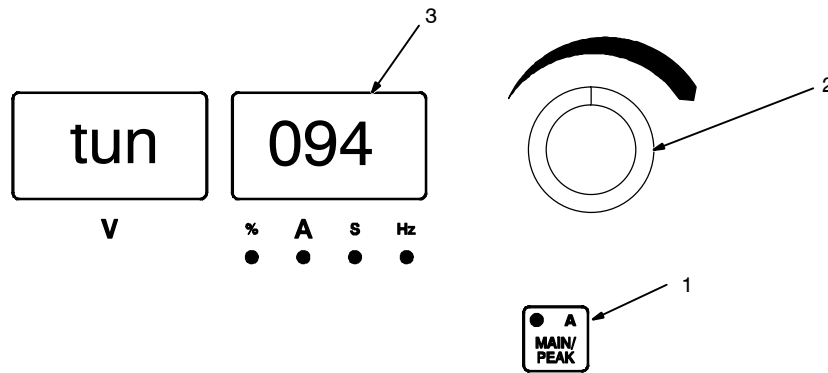

- 1 Amperage Switch Pad
- 2 Encoder Control
- 3 Amps Meter

Preset TIG Start Parameters

Use Encoder control to select a tungsten size from the following: .020, .040, .062 (1/16 in.), .094 (3/32 in.), or .125 (1/8 in.) (.094 is the default). When one of the listed tungsten sizes is selected, the following TIG starting parameters are preset: Am-

perage, Start Time, Start Slope Time, and Preset Amperage Minimum. If it is necessary or desired to manually set the TIG starting parameters, turn the encoder until [GEn] is displayed on the amps meter (see Section B).

B. Selecting GEN

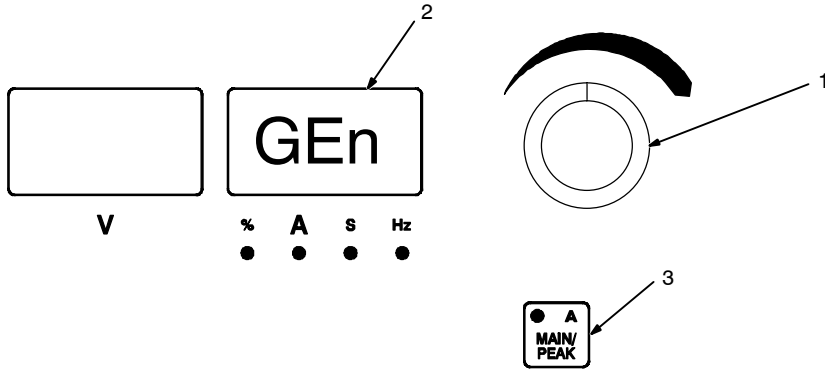

- 1 Encoder Control
- 2 Amps Meter
- 3 Amperage Switch Pad

If [GEN] is selected and displayed on the amps meter, the TIG starting parameters for a .094 tungsten are the default: Start Amperage = 60 A, Start Time = 1 ms, Start Slope Time = 40 ms, Preset Minimum Amps = 3 A. These parameters can be manually changed by pressing the Amperage switch pad to step through each adjustable parameter. To change parameters, see Sections C, D, E, and F.

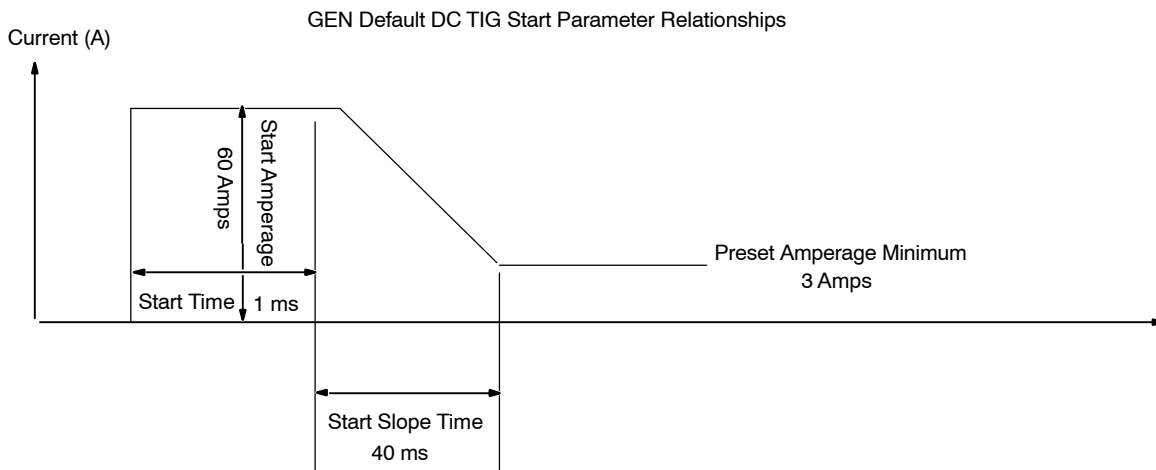

C. Changing Programmable TIG Start Amperage

1 Amperage Switch Pad

2 Encoder Control

3 Amps Meter

To adjust TIG Start Amperage proceed as follows:
Press Amperage switch pad. Switch pad LED turns on, and meter A LED turns on. The current Start Amperage is displayed on

the amps meter, and can be adjusted (see Section 5-13) by turning the Encoder control.
To change Start Time, proceed to Section D.

D. Changing Programmable Start Time

1 Amperage Switch Pad

2 Encoder Control

3 Amps Meter

To adjust Programmable Start Time proceed as follows:
Press Amperage switch pad, and meter S LED turns on. The current Start Time is displayed in milliseconds on the amps meter,

and can be adjusted by turning the Encoder control (see Section 5-13).
To change Start Slope Time, proceed to Section E.

E. Changing Start Slope Time

The diagram illustrates the process of adjusting the Start Slope Time. On the left, a graph plots Current (A) against time. The current rises to a plateau, then ramps down linearly. A horizontal double-headed arrow below the ramp is labeled 'Start Slope Time'. To the right, the control panel features a display showing 'StS' and '20', an encoder knob (2), and a switch pad (1) with 'A MAIN/PEAK' indicators. Below the display are four LEDs labeled '%', 'A', 'S', and 'Hz'.

- 1 Amperage Switch Pad
- 2 Encoder Control
- 3 Amps Meter

To adjust Start Slope Time proceed as follows:
 Press Amperage switch pad. Switch pad LED turns on, and meter S LED turns on. The Start Slope Time is displayed in milli-seconds on the amps meter, and can be adjusted (see Section 5-13) by turning the Encoder control.
 To change Preset Amperage Minimum, proceed to Section F.

F. Changing Preset Amperage Minimum

The diagram illustrates the process of adjusting the Preset Amperage Minimum. On the left, a graph plots Current (A) against time. The current rises to a plateau, then ramps down linearly. A horizontal line at the end of the ramp is labeled 'Preset Amperage Minimum'. To the right, the control panel features a display showing 'PA_' and '5', an encoder knob (2), and a switch pad (1) with 'A MAIN/PEAK' indicators. Below the display are four LEDs labeled '%', 'A', 'S', and 'Hz'.

- 1 Amperage Switch Pad
- 2 Encoder Control
- 3 Amps Meter

To adjust Preset Amperage Minimum proceed as follows:
 Press Amperage switch pad. Switch pad LED turns on, and meter A LED turns on. The Preset Minimum Amperage is displayed on the amps meter, and can be adjusted (see Section 5-13) by turning the Encoder control.

ⓘ Whatever amperage is selected as the preset amperage minimum, is the minimum amperage that the machine will provide.

6-3. Output Control And Trigger Functions

A. Remote (Standard) Torch Trigger Operation

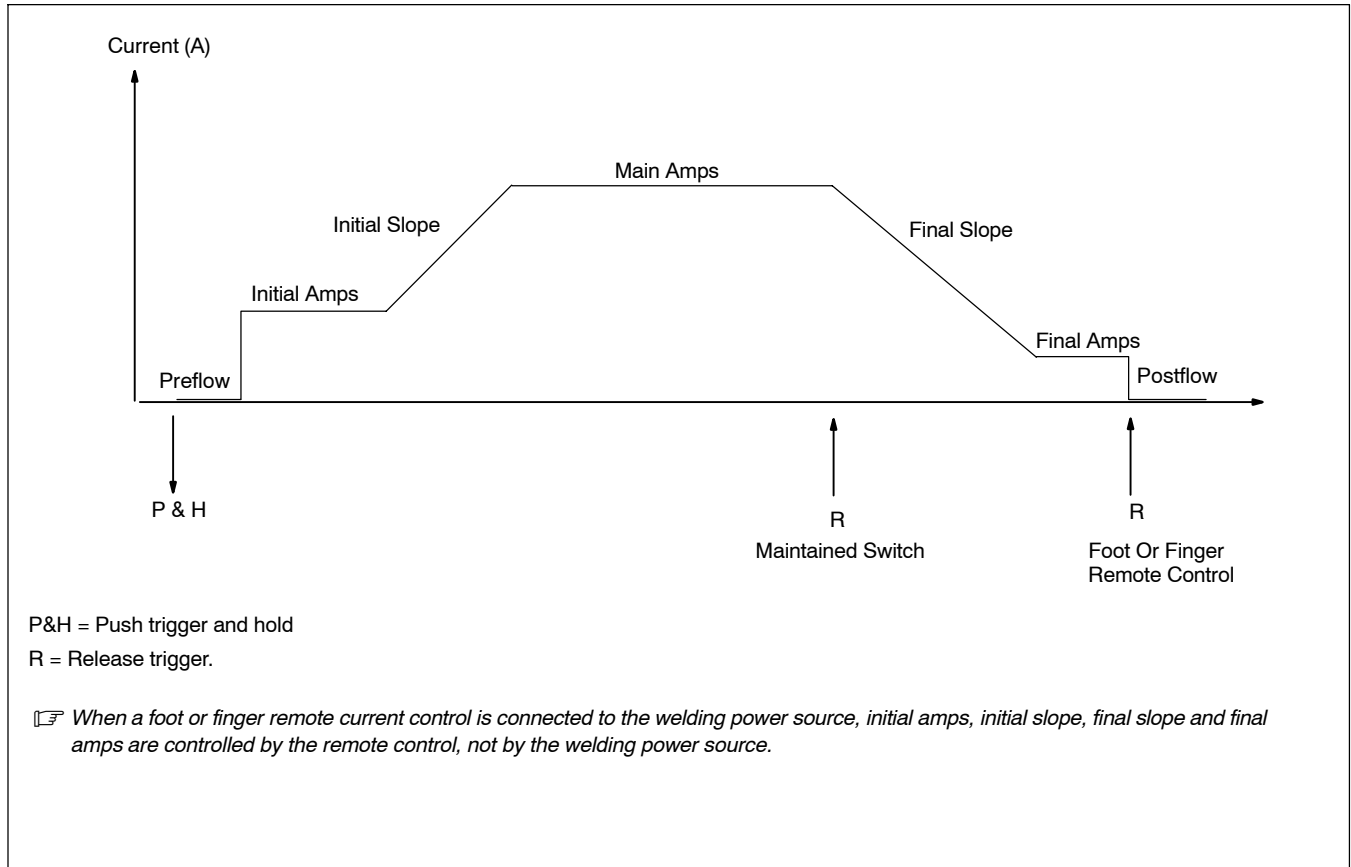

B. Remote 2T Torch Trigger Operation

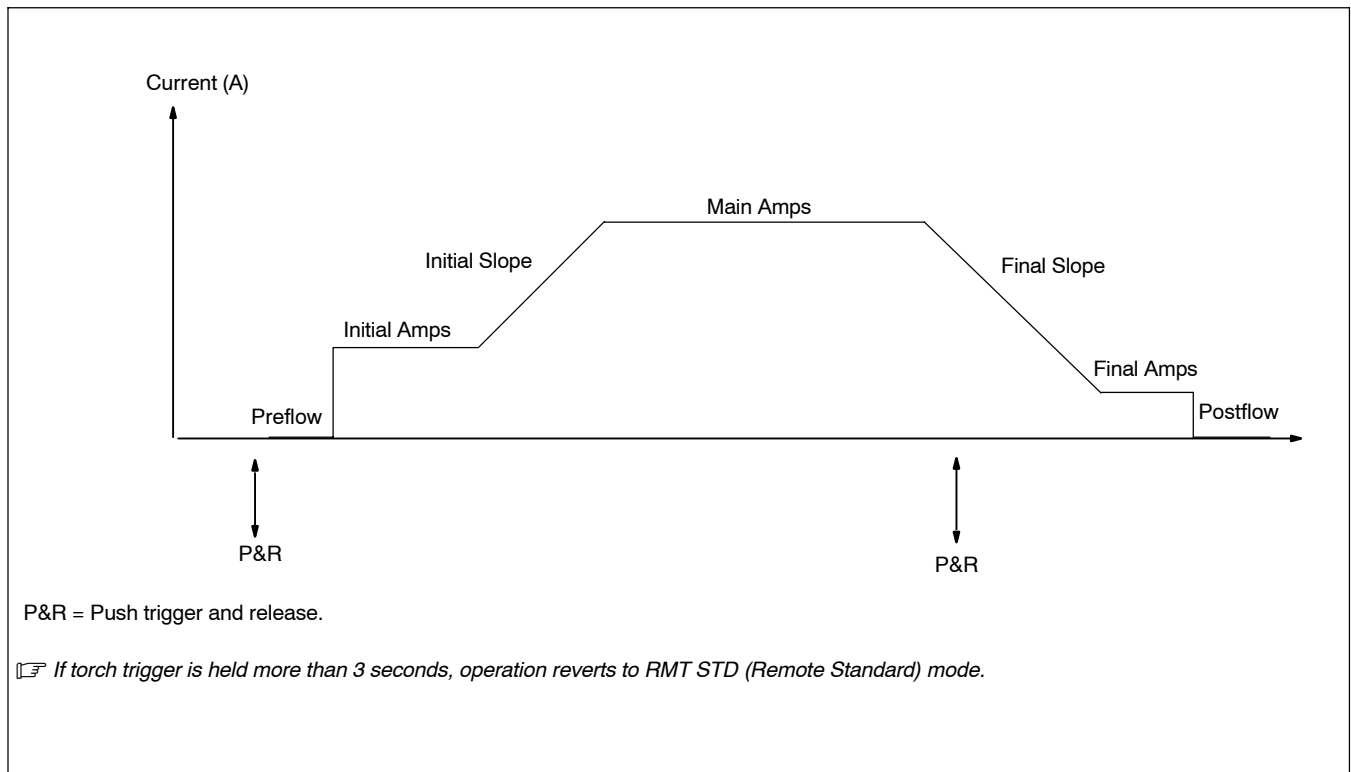

C. 3T Specific Trigger Method

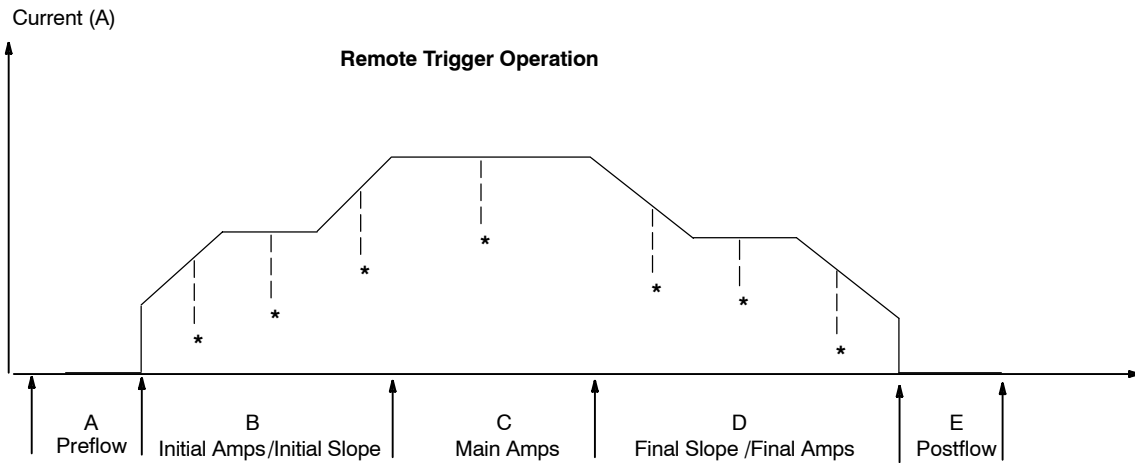
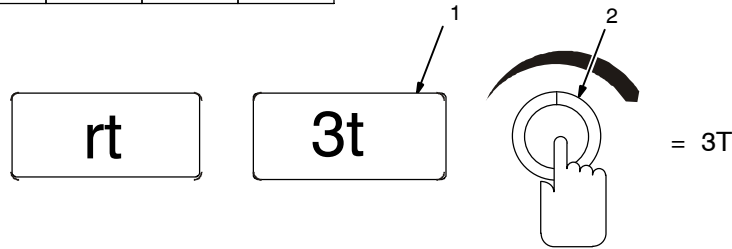

* Arc can be extinguished at any time by pressing and releasing both initial and final switches, or by lifting the torch and breaking the arc.

1 3T (Specific Trigger Operation)

Sequencer is required to reconfigure for 3T.

3T requires a specific type of remote control with two independent momentary-contact switches. One will be designated initial switch, and it must be connected between Remote 14 receptacle pins A and B. The second will be designated as the final switch, and it must be connected between Remote 14 receptacle pins D and E.

2 Encoder Control

To select 3T, turn Encoder control.

Definitions:

Initial slope rate is the rate of amperage change determined by the initial amperage, initial slope time, and main amperage.

Final slope rate is the rate of amperage change determined by the main amperage, final slope time, and final amperage.

Operation:

A. Press and release initial switch within 3/4 second to start shielding gas flow. To stop the preflow sequence before preflow time elapses (25 seconds), press and release final switch. The preflow timer will reset and the weld sequence can be started again.

If an initial switch closure is not made again before preflow time ends, gas flow stops, the timer resets, and an initial switch press and release is necessary to start the weld sequence again.

B. Press initial switch to start arc at initial amps. Holding switch will change amperage at initial slope rate (release switch to weld at desired amperage level).

C. When main amperage level is reached, initial switch can be released.

D. Press and hold the final switch to decrease amperage at final slope rate (release switch to weld at desired amperage level).

E. When final amperage has been reached, the arc extinguishes and shielding gas flows for the time set on the Postflow control.

Application:

With the use of two remote switches instead of potentiometers, 3T gives the operator the ability to infinitely increase, decrease, or pause and hold amperage within the range determined by the initial, main, and final amperages.

D. 4T Specific Trigger Method

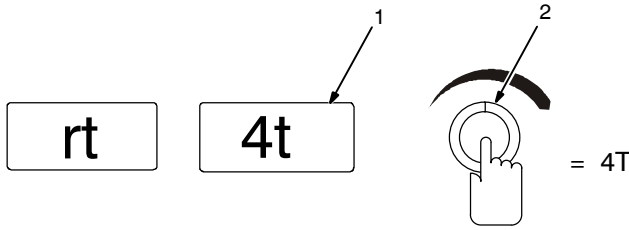

- 1 4T (Specific Trigger Operation)
- 2 Encoder Control

To select 4T, turn Encoder control.

Torch trigger operation is as shown.

4T allows the operator to toggle between weld current and final current.

☞ When a remote switch is connected to the welding power source, use the remote switch to control the weld cycle. Amperage is controlled by the welding power source.

Application:

Use 4T trigger method when the functions of a remote current control are desired, but only a remote on/off control is available.

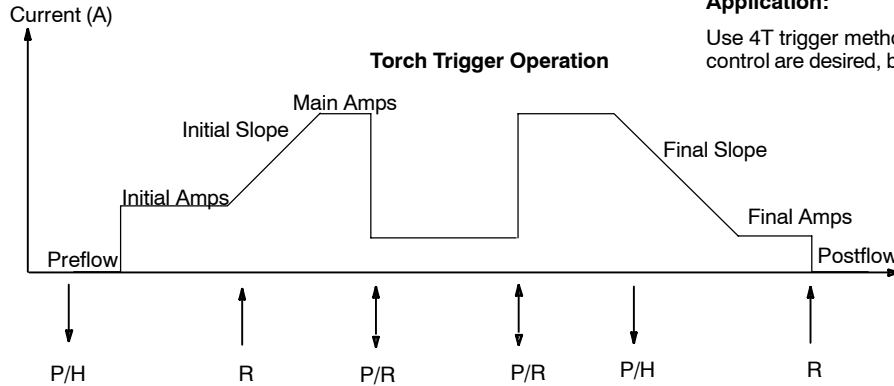

P/H = Push and hold trigger; R = Release trigger; P/R = Push trigger and release in less than 3/4 seconds

E. Mini Logic Operation

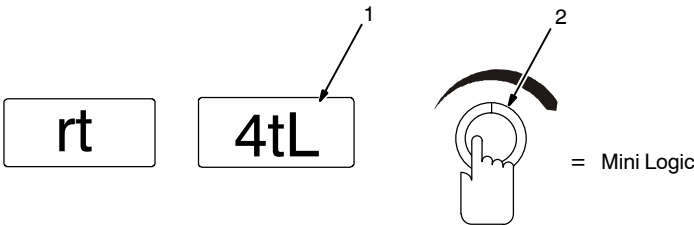

- 1 Mini Logic Meter Display
- 2 Encoder Control

To select Mini Logic, turn Encoder control.

Torch trigger operation is as shown.

Mini logic allows the operator to toggle between initial slope or main amps and initial amps. Final Amperage is not available. Final slope will always slope to minimum amperage and end the cycle.

☞ When a remote switch is connected to the welding power source, use the remote switch to control the weld cycle. Amperage is controlled by the welding power source.

Application: This ability to change current levels without either initial slope or final slope, gives the operator the opportunity to adjust filler metal without breaking the arc.

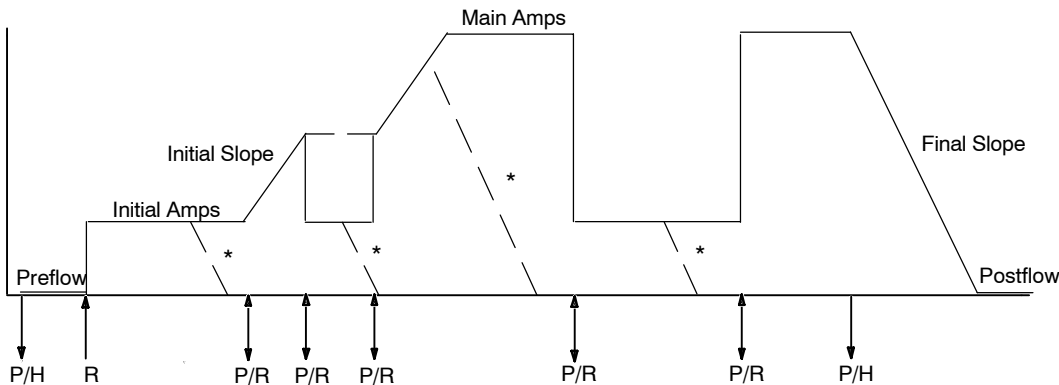

P/H = Push and hold trigger; R = Release trigger; P/R = Push trigger and release in less than 3/4 seconds

* = Arc can be extinguished at final slope rate at any time by pushing and holding trigger

F. 4T Momentary Operation

1 4T Momentary Meter Display

2 Encoder Control

To select 4T Momentary, turn Encoder control.

4T Momentary torch trigger operation is as shown.

☞ When a remote switch is connected to the welding power source, use the remote switch to control the weld cycle. Amperage is controlled by the welding power source.

Application:

Use 4T Momentary trigger method when the functions of a remote current control are desired, but only a remote on/off control is available.

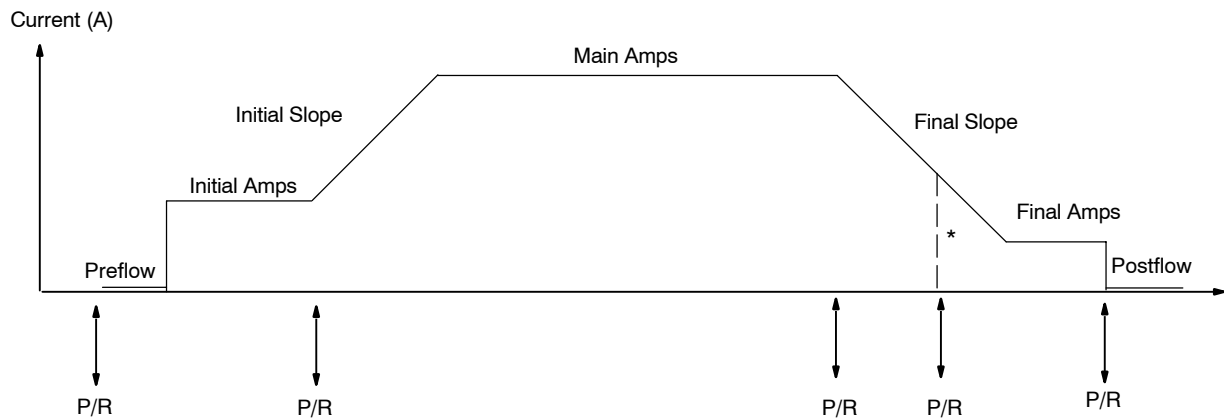
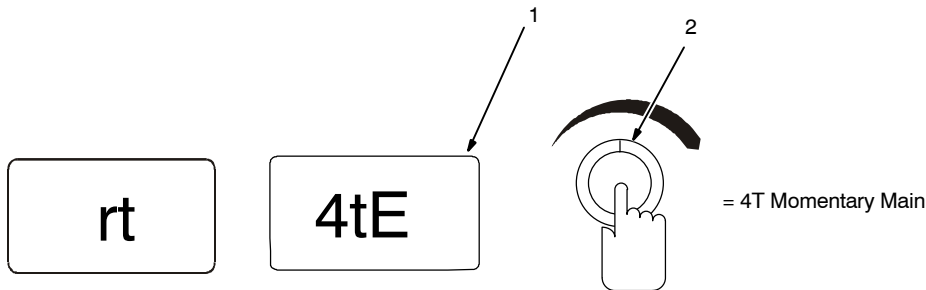

P/R = Push and release trigger; * = Push and releasing during final slope will break the arc and go to postflow

☞ For first torch trigger push & release, if trigger is held more than 3 seconds, trigger cycle ends.

G. Spot Control Operation

1 Spot Function Meter Display

☞ While in Spot Control, Sequencer settings will be ignored and will not be programmable.

☞ When a remote switch is connected to the welding power source, use the remote switch to control the weld cycle. Amperage is controlled by the welding power source.

Torch trigger operation is as shown.

Application: To provide a timed weld. Used for tacking, and thin sheet joining.

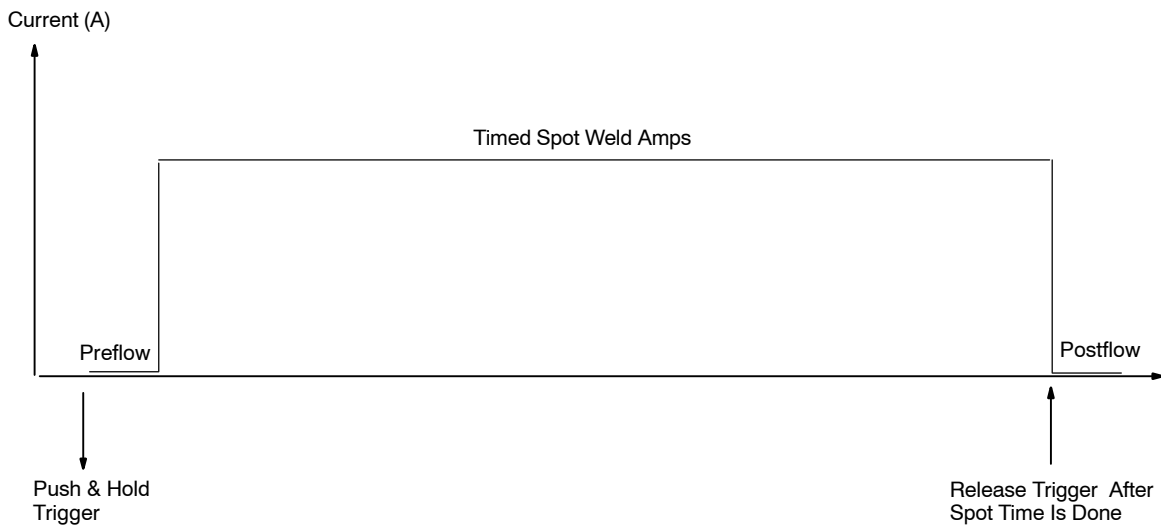
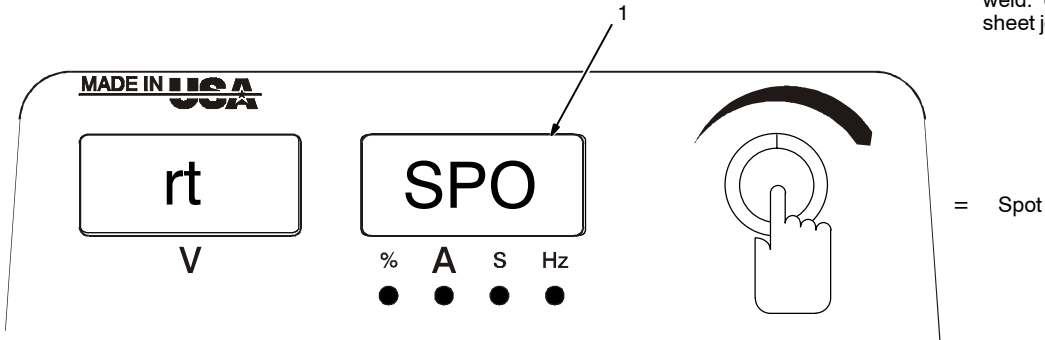

H. On Trigger Operation

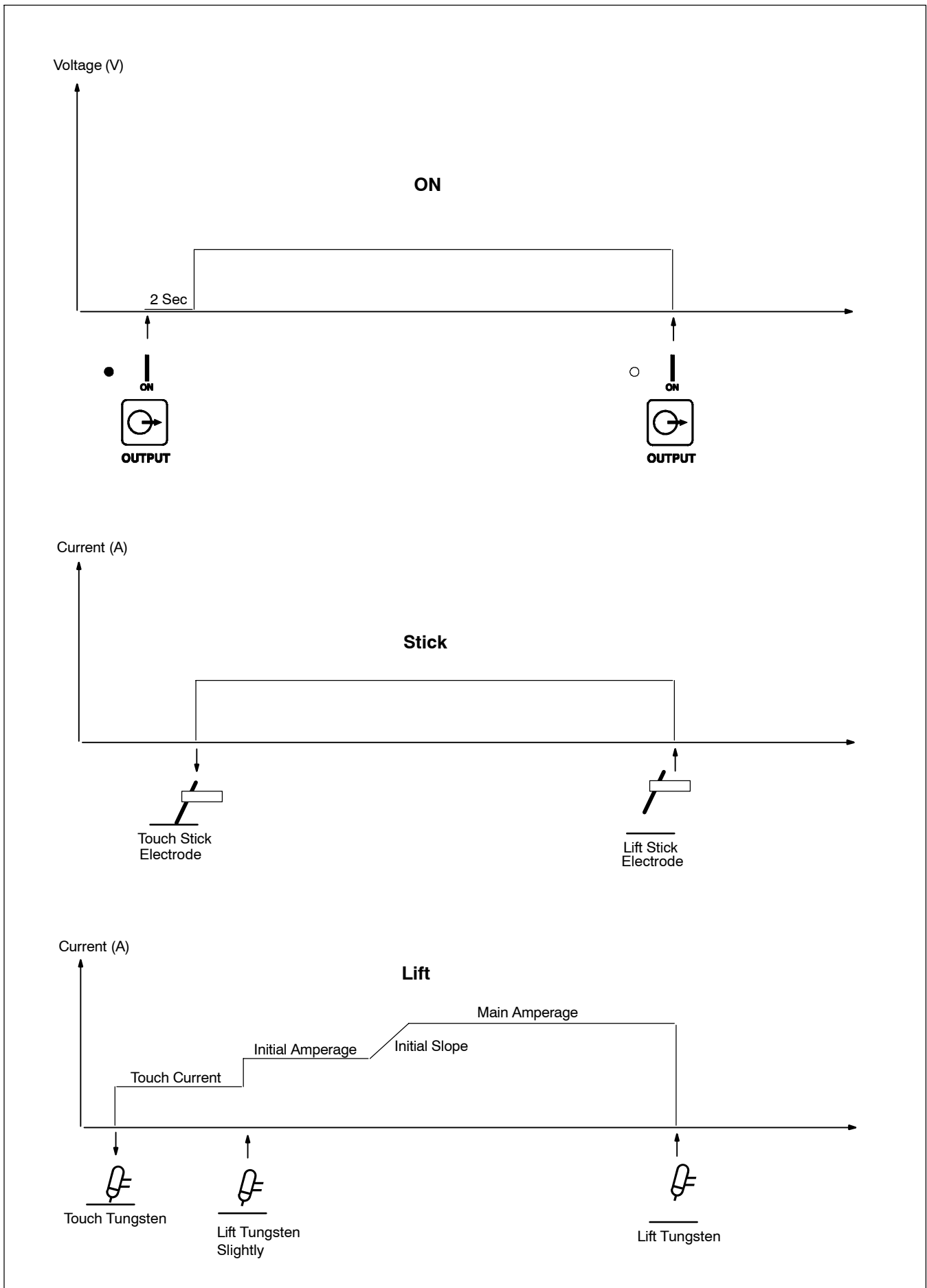

6-4. Setting Preflow Time



1 Encoder Control

Turn encoder to select from 0 to 25 seconds of preflow. The value selected is displayed on the ammeter.

Application: Preflow is used to purge the immediate weld area of atmosphere. Preflow also aids in consistent arc starting.

6-5. Stick Open-Circuit Voltage (OCV) Selection

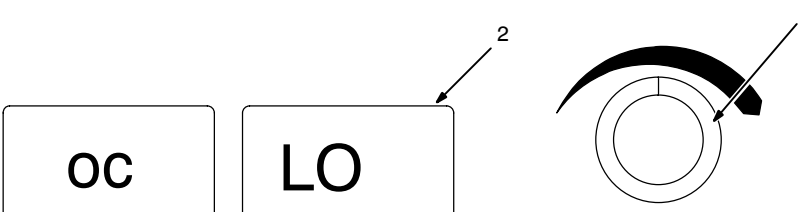

1 Encoder Control

2 Meter Display

Turn Encoder to change between low OCV and normal OCV. Active selection is displayed on the meters.

When Stick low OCV is selected, open-circuit voltage is between 9 and 14 volts. When Stick normal OCV is selected, open-circuit voltage is approximately 72 volts.

Application: For most Stick applications use low open-circuit voltage. Use normal open-circuit voltage for hard to start Stick electrodes, or if required for your particular application.

6-6. Stick Stuck Check Selection

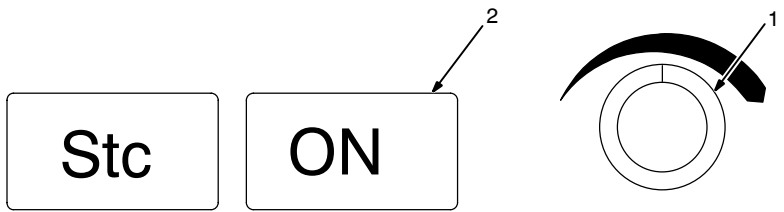

1 Encoder Control

2 Ammeter Parameters Select Display

Turn Encoder to change between Stick Stuck Check [ON and [OFF] meter display. When Stick Stuck Check is on and the welding electrode (rod) is stuck, output is turned off.

Application: For most Stick applications, use Stick Stuck Check off. With Stick Stuck Check on and the welding electrode (rod) stuck, output is turned off in an attempt to save the rod for reuse. This allows the operator time to un-stick the rod, or disconnect the rod holder from the rod without arc occurring. Turn Stick Stuck Check on when this function is desired.

Some applications may require Stick Stuck Check to be turned off. For example: Large stick electrodes operating at high amperages would require Stick Stuck Check to be turned off.

6-7. Lockout Functions

A. Accessing Lockout Capability

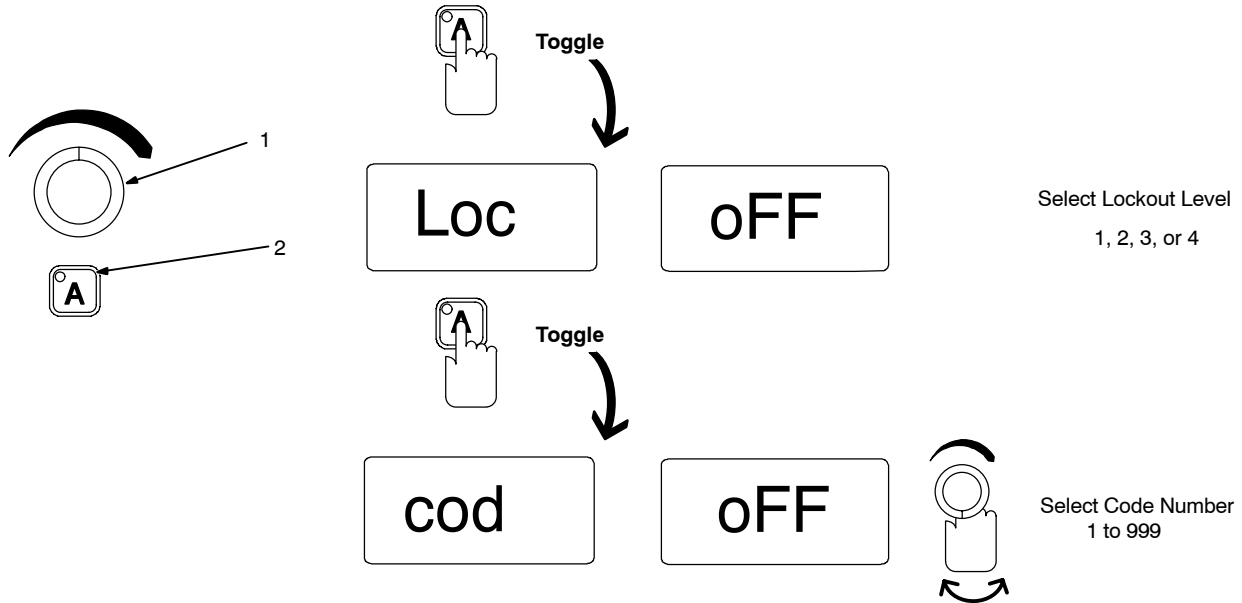

See Section 5 for explanation of controls referred to in all of Section 6-7.

There are four (1–4) different lockout levels. Each successive level allows the operator more flexibility.

Before activating lockout levels, be sure that all procedures and parameters are established. Parameter adjustment is limited while lockout levels are active.

To turn On the lockout feature, proceed as follows:

- 1 Encoder Control
- 2 Amperage (A) Switch Pad

Press Amperage (A) switch pad to toggle between the lock and code displays. Toggle switch pad until code is displayed.

Turn Encoder control to select a lockout code number. The code number will appear on the amp meter. Select any number from [1

thru [999]. **IMPORTANT:** remember this code number, as you will need it to turn the lockout feature off.

Toggle Amperage (A) switch pad until lock is displayed. You may now select a lockout level.

There are four lockout levels available. Turn Encoder control to select a lockout level (see Sections 6-7B for lockout level descriptions).

Once the desired three digits have been entered and a lockout level selected, exit advanced functions mode (see Section 6).

To turn Off the lockout feature, proceed as follows:

Use Encoder control to enter the same code number that was used to turn on the lockout feature.

Press the Amperage (A) switch pad. The amperage (right) meter display will change to [OFF]. The lockout feature is now off.

B. Lockout Levels

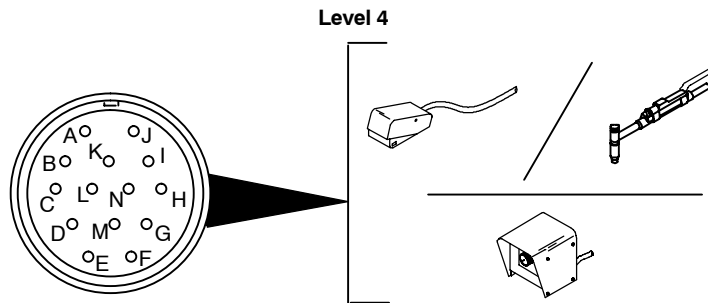
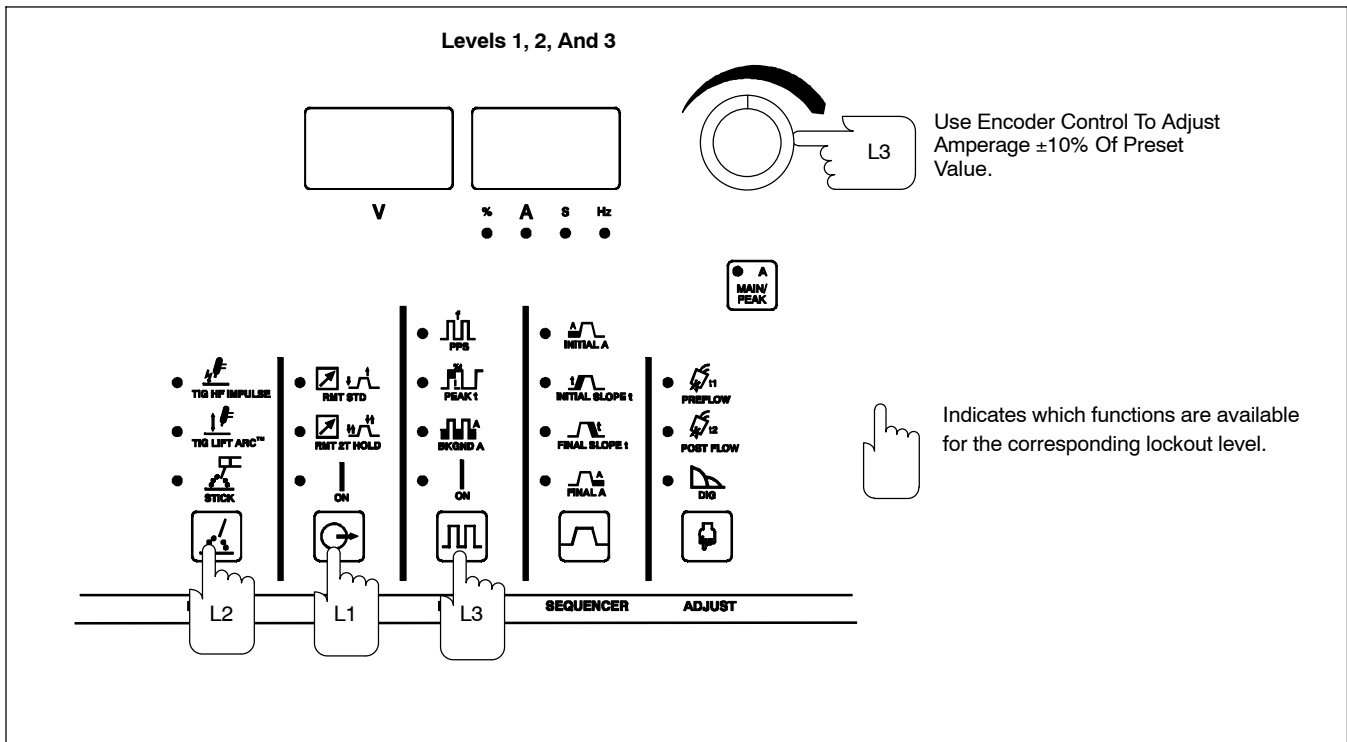

☞ Before activating lockout levels, be sure that all procedures and parameters are established. Parameter adjustment is limited while lockout levels are active.

Level 1

☞ Remote amperage control is not available in level 1.

TIG Output Selection

If either the TIG HF Impulse or TIG Lift Arc process (see Section 5-6) was active when lockout level 1 was activated, the operator can choose between RMT STD (Remote Standard) or RMT 2T HOLD (Remote 2T Hold) (see Section 5-8). The On function is also available if TIG Lift Arc was active.

Stick Output Selection

If the Stick process was active when lockout level 1 was activated, the operator can choose between RMT STD or On.

When parameter change or selection is limited

by lock level 1, [LOCK][LEV1] is displayed as a reminder.

Level 2

☞ Remote amperage control is not available in level 2.

Includes all the functions of level 1 plus Process Selection (see Section 5-6).

When parameter change or selection is limited by lock level 2, [LOCK][LEV2] is displayed as a reminder.

Level 3

☞ Remote amperage control is not available in level 3.

Includes all the functions of levels 1 and 2 plus the following:

$\pm 10\%$ adjustment of preset TIG or Stick Weld Amps

Select desired process, TIG or Stick, and use Encoder control to adjust amperage $\pm 10\%$ of preset amperage value, up to the

limits of the machine. If operator tries to go beyond the $\pm 10\%$, the amperage (right) meter will display [LOCK][LEV3] as a reminder.

Pulsar ON/Off Control

Gives operator the ability to turn on/off the Pulsar control.

When parameter change or selection is limited by lock level 3, [LOCK][LEV3] is displayed as a reminder.

Level 4

Includes all the functions of levels 1, 2, and 3 plus the following:

Remote Amperage Control

Allows operator to use remote amperage control if desired. Remote control operates from minimum to maximum of preset amperage value. Connect remote control device according to Section 4-8.

When parameter change or selection is limited by lock level 4, [LOCK][LEV4] is displayed as a reminder.

6-8. Setting Unit To Display PPP While Pulse Welding (DX Models Only)

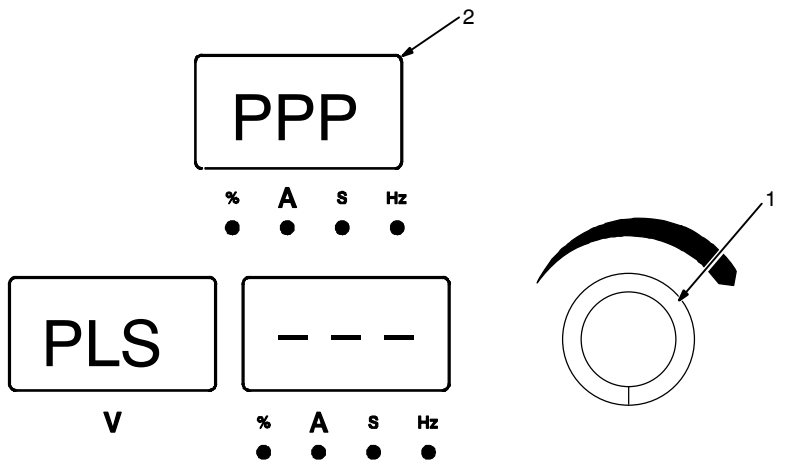

The diagram illustrates the unit's display and encoder control. On the left, there are two digital displays. The top display shows 'PPP' and is labeled '2'. Below it are four indicator lights labeled '%', 'A', 'S', and 'Hz'. The bottom display shows 'PLS' and is labeled 'V'. Below it are also four indicator lights labeled '%', 'A', 'S', and 'Hz'. To the right is a rotary encoder knob labeled '1' with a curved arrow indicating its rotation.

- Encoder Control
- PPP Meter Display

Turn Encoder to change between standard and [PPP] meter display.

When the [PPP] meter display feature is active while pulse welding, the [PPP] will be displayed on the right meter display, and the Meter Hold feature is disabled.

The [PPP] meter display feature will not effect the normal amperage display or Meter Hold capabilities when in a non-pulse welding mode.

6-9. External Pulse Control

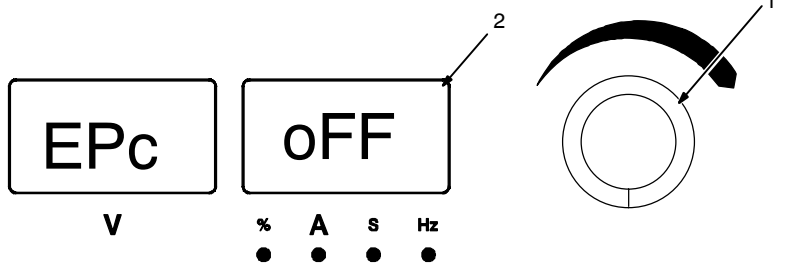

The diagram illustrates the unit's display and encoder control for External Pulse Control. On the left, there are two digital displays. The top display shows 'EPc' and is labeled 'V'. The bottom display shows 'OFF' and is labeled '2'. Below both displays are four indicator lights labeled '%', 'A', 'S', and 'Hz'. To the right is a rotary encoder knob labeled '1' with a curved arrow indicating its rotation.

- Encoder Control
- Ammeter Parameter Selection

Turn Encoder to select external pulse control on or off (off is the default).

When external pulse control is on: Remote 14-pin amperage control of 0 to 10 volts input will be a minimum 0 amps to the power source, a maximum 200 amps with an external direct amperage control to power source.

SECTION 7 – MAINTENANCE AND TROUBLESHOOTING

7-1. Routine Maintenance

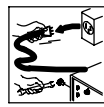

Disconnect power before maintaining.

Maintain more often during severe conditions.

A. Welding Power Source

	✓ = Check * To be done by Factory Authorized Service Agent	◇ = Change	● = Clean	Δ = Repair	☆ = Replace
Every 3 Months	 ✓☆ Labels	 ✓☆ Labels	 ✓☆ Gas Hoses		
Every 3 Months	 ✓Δ ☆Cables And Cords				
Every 6 Months	 Do not remove case when blowing out inside of unit (see Section 7-2) . ●:During heavy service, clean monthly.				

B. Optional Cooler

	✓ = Check * To be done by Factory Authorized Service Agent	◇ = Change	● = Clean	Δ = Repair	☆ = Replace
Every 3 Months	 ● Coolant Strainer, during heavy service, clean more frequently.			● Blow out heat exchanger fins. ✓ Check coolant level. Top off with distilled or deionized water if necessary.	
Every 6 Months		 ✓☆ Hoses			 ✓☆ Labels
Every 12 Months	 ◇ Replace coolant.				

7-2. Blowing Out Inside Of Unit

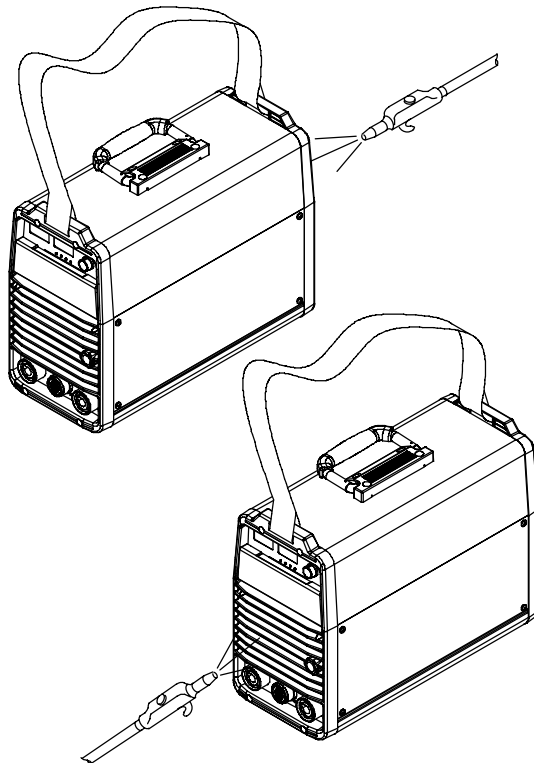

⚠ Do not remove case when blowing out inside of unit.

To blow out unit, direct airflow through front and back louvers as shown.

ST-802 451

7-3. Voltmeter/Ammeter Help Displays

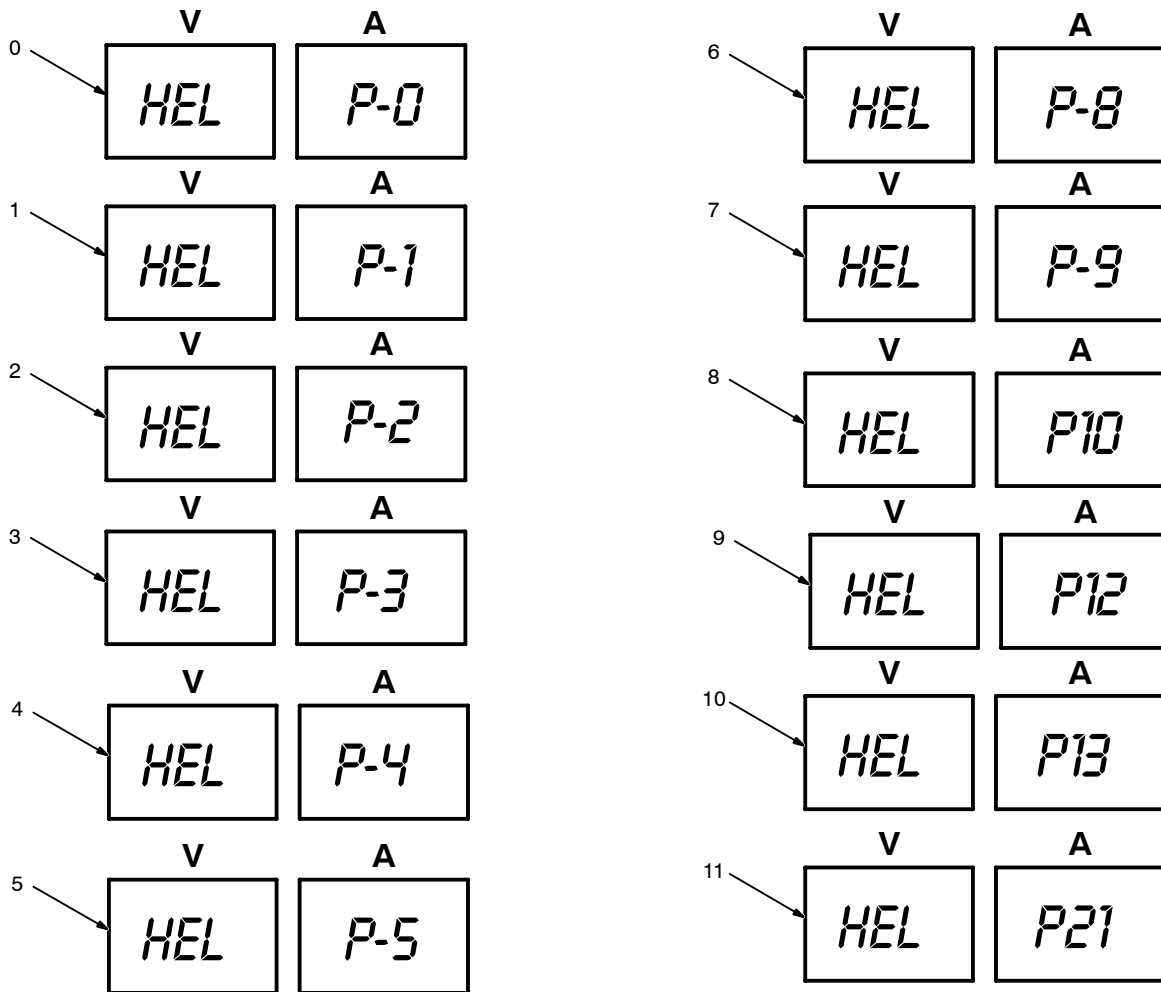

All directions are in reference to the front of the unit. All circuitry referred to is located inside the unit.

0 Help 0 Display

Indicates a short in the thermal protection circuitry located on the bottom heat sink. Contact a Factory Authorized Service Agent if this display is shown.

1 Help 1 Display

Indicates a malfunction in the primary power circuit caused by an overcurrent condition in the primary IGBT switching circuit. Contact a Factory Authorized Service Agent if this display is shown.

2 Help 2 Display

Indicates an open in the thermal protection circuitry located on the bottom heat sink. Contact a Factory Authorized Service Agent if this display is shown.

3 Help 3 Display

Indicates the bottom heat sink has overheated. The unit has shut down to allow the fan to cool it (see Section 4-5). Operation will continue when the unit has cooled.

4 Help 4 Display

Indicates an open in the thermal protection circuitry located on the top heat sink. Contact a Factory Authorized Service Agent if this display is shown.

5 Help 5 Display

Indicates the top heat sink has overheated. The unit has shut down to allow the fan to cool it (see Section 4-5). Operation will continue when the unit has cooled.

6 Help 8 Display

Indicates a malfunction in the secondary power circuit of the unit. There is a high open circuit condition. Contact a Factory Authorized Service Agent if this display is shown.

7 Help 9 Display

Indicates a short in the thermal protection circuitry located on the top heat sink. Contact a Factory Authorized Service Agent if this display is shown.

8 Help 10 Display

Indicates torch trigger is depressed. Release trigger to continue.

9 Help 12 Display

Indicates an improper set-up. You are trying to make an adjustment that is not allowed.

10 Help 13 Display (LX Models Only)

Output enable signal broken causing weld output to stop, but gas continues to flow if Post Flow function is active or gas control on 10-pin is On (see Section 4-9).

11 Help Display 21

Indicates voltage or current feedback has been detected with contactor off. Contact a Factory Authorized Service Agent if this display is shown.

7-4. Troubleshooting



Trouble	Remedy
No weld output; unit completely inoperative.	Place line disconnect switch in On position (see Section 4-16).
	Check and replace line fuse(s), if necessary, or reset circuit breaker (see Section 4-16).
	Check for proper input power connections (see Section 4-16).
No weld output; meter display On.	If using remote control, be sure correct process is enabled to provide output control at Remote 14 receptacle (see Section 4-8 as applicable).
	Input voltage outside acceptable range of variation (see Section 4-15).
	Check, repair, or replace remote control.
	Unit overheated. Allow unit to cool with fan On (see Section 4-5).
Erratic or improper weld output.	Use proper size and type of weld cable (see Section 4-7).
	Clean and tighten all weld connections (see Section 4-7).
Fan not operating.	Check for and remove anything blocking fan movement.
	Have Factory Authorized Service Agent check fan motor.
Wandering arc	Use proper size tungsten (see Section 11).
	Use properly prepared tungsten (see Section 11).
	Reduce gas flow rate (see Section 4-11).
Tungsten electrode oxidizing and not remaining bright after conclusion of weld.	Shield weld zone from drafts.
	Increase postflow time (see Section 5-1).
	Check and tighten all gas fittings (see Section 4-11).
	Water in torch. Refer to torch manual.

SECTION 8 – ELECTRICAL DIAGRAMS

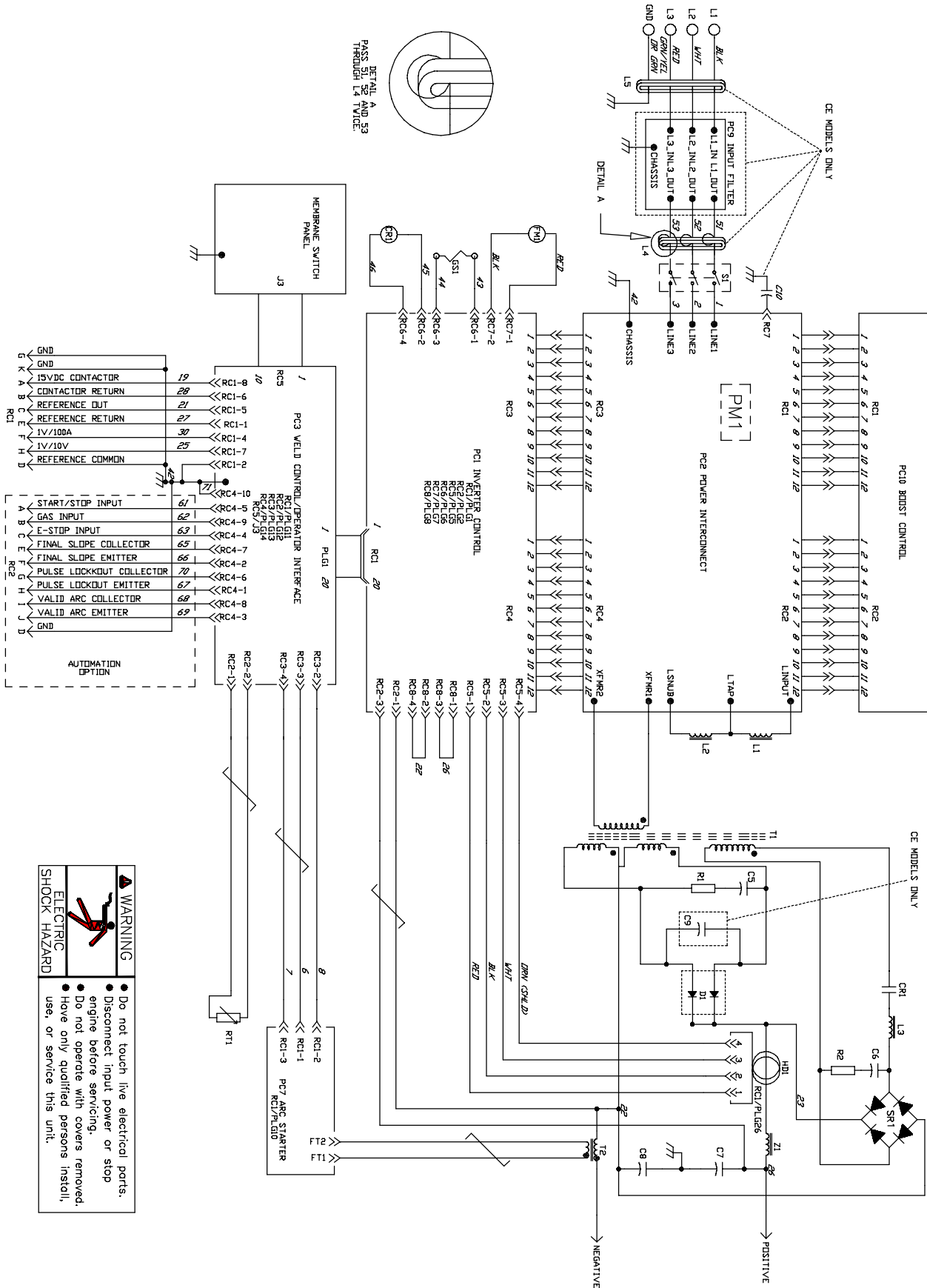
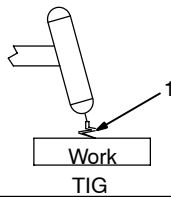

Figure 8-1. Circuit Diagram

SECTION 9 – HIGH FREQUENCY (HF)

9-1. Welding Processes Requiring High Frequency



1 High-Frequency Voltage

TIG – helps arc jump air gap between torch and workpiece and/or stabilize the arc.

9-2. Correct Installation

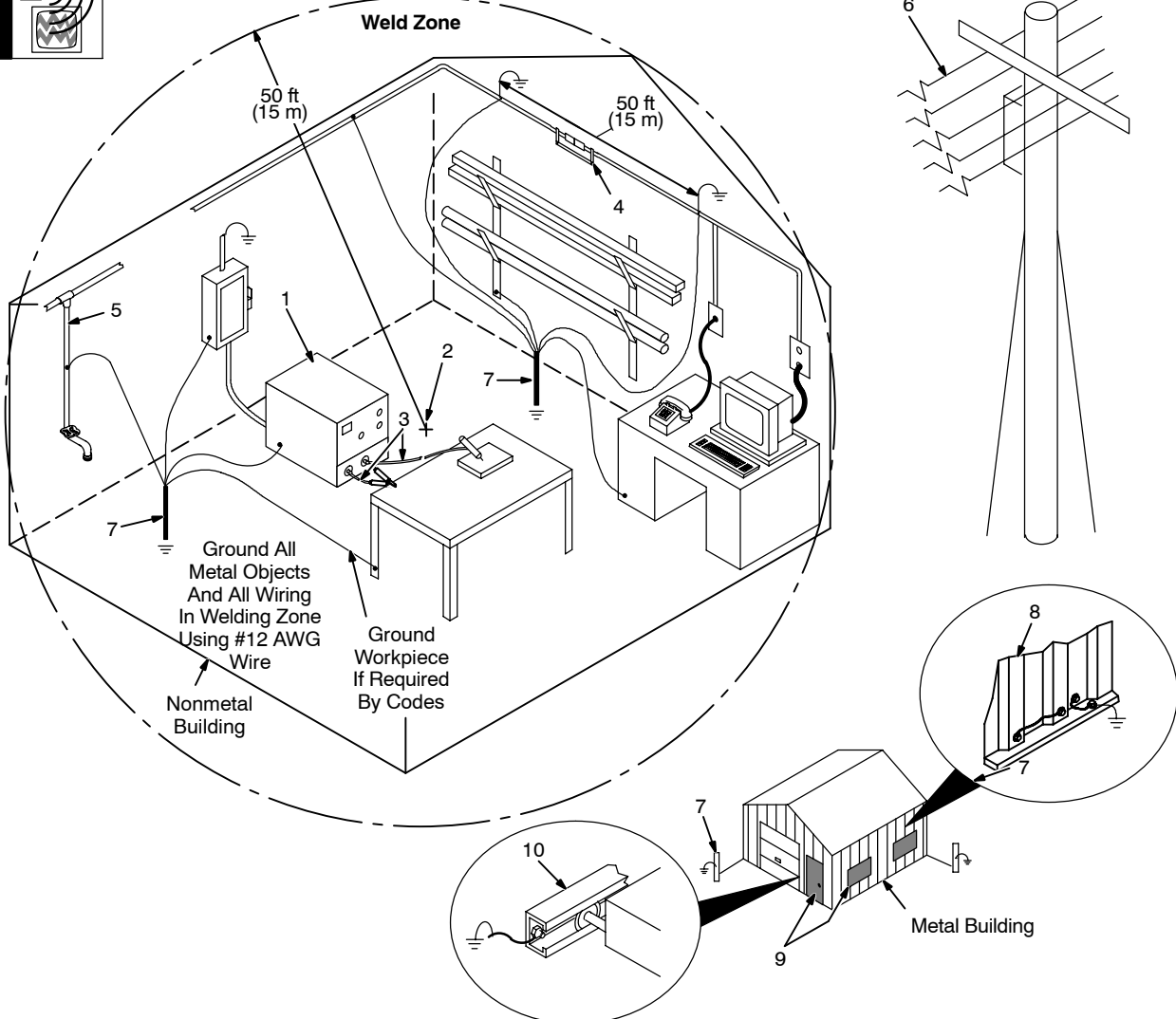

1 HF Source (Welder With Built-In HF Or Separate HF Unit)

Ground metal machine case, work output terminal, line disconnect device, input supply, and worktable.

2 Welding Zone And Centerpoint

A circle 50 ft (15 m) from centerpoint between HF source and welding torch in all directions.

3 Weld Output Cables

Keep cables short and close together.

4 Conduit Joint Bonding And Grounding

Electrically join (bond) all conduit sections using copper straps or braided wire. Ground conduit every 50 ft (15 m).

5 Water Pipes And Fixtures

Ground water pipes every 50 ft (15 m).

6 External Power Or Telephone Lines

Locate HF source at least 50 ft (15 m) away from power and phone lines.

7 Grounding Rod

Consult the National Electrical Code for specifications.

8 Metal Building Panel Bonding Methods

Bolt or weld building panels together, install copper straps or braided wire across seams, and ground frame.

9 Windows And Doorways

Cover all windows and doorways with grounded copper screen of not more than 1/4 in (6.4 mm) mesh.

10 Overhead Door Track

Ground the track.

SECTION 10 – SETUP GUIDES FOR (GTAW) TIG WELDING



10-1. DC - GTAW 16 Gauge Stainless Steel Set-Up

MADE IN USA

Ammeter

Encoder

V
%
A
S
Hz

TIG HF IMPULSE

TIG LIFT ARC™

STICK

RMT STD

RMT 2T HOLD

ON

PPS

PEAK t

BKGND A

ON

INITIAL A

INITIAL SLOPE t

FINAL SLOPE t

FINAL A

MAIN/PEAK

POST FLOW

DIG

PROCESS
OUTPUT
PULSER
SEQUENCE
ADJUST

This symbol indicates which functions should be active for stainless steel.

- Turn power on (switch located on rear panel)
- Press Process switch pad until TIG HF Impulse LED is lit
- Press Output switch pad until RMT STD LED is lit
- Press Adjust switch pad until Post Flow LED is lit
- Turn Encoder control to set 8 seconds of Post Flow time
- Press Amperage **A** switch pad until LED is lit
- Turn Encoder control to set desired amperage (50 - 80 amps).

The ammeter displays the parameter for any of the following units of measure when they are active: amperage, time, percentage, or frequency. The corresponding LED, located directly below the ammeter, will also light up. The ammeter also displays actual amperage while welding.

207 690-A

SECTION 11 – SELECTING AND PREPARING A TUNGSTEN FOR DC OR AC WELDING WITH INVERTER MACHINES

gtaw_Inverter_2010-04



Whenever possible and practical, use DC weld output instead of AC weld output.

11-1. Selecting Tungsten Electrode (Wear Clean gloves To Prevent Contamination Of Tungsten)

Electrode Diameter	Amperage Range - Gas Type♦ - Polarity	
	(DCEN) – Argon Direct Current Electrode Negative (For Use With Mild Or Stainless Steel)	AC – Argon Balance Control @ 65% Electrode Negative (For Use With Aluminum)
2% Ceria (Orange Band), 1.5% Lanthanum (Gray Band), Or 2% Thorium (Red Band) Alloy Tungstens		
.010 in. (1 mm)	Up to 25	Up to 20
.020 in. (1 mm)	15-40	15-35
.040 in. (1 mm)	25-85	20-80
1/16 in. (1.6 mm)	50-160	50-150
3/32 in. (2.4 mm)	130-250	135-235
1/8 in. (3.2 mm)	250-400	225-360
5/32 in. (4.0 mm)	400-500	300-450
3/16 in. (4.8 mm)	500-750	400-500
1/4 in. (6.4 mm)	750-1000	600-800

♦ Typical argon shielding gas flow rates are 11 to 35 cfh (cubic feet per hour).

Figures listed are a guide and are a composite of recommendations from American Welding Society (AWS) and electrode manufacturers.

11-2. Preparing Tungsten Electrode For DC Electrode Negative (DCEN) Welding Or AC Welding With Inverter Machines



Grinding the tungsten electrode produces dust and flying sparks which can cause injury and start fires. Use local exhaust (forced ventilation) at the grinder or wear an approved respirator. Read MSDS for safety information. Consider using tungsten containing ceria, lanthana, or yttria instead of thoria. Grinding dust from thoriated electrodes contains low-level radioactive material. Properly dispose of grinder dust in an environmentally safe way. Wear proper face, hand, and body protection. Keep flammables away.

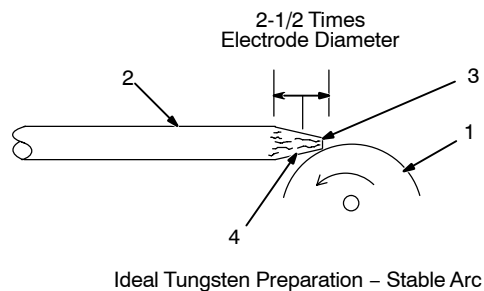
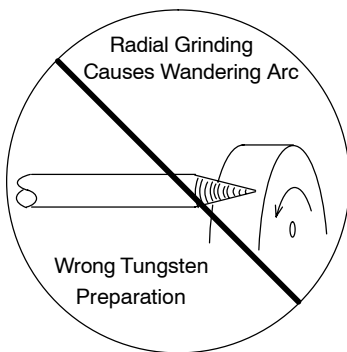

1 Grinding Wheel

Grind end of tungsten on fine grit, hard abrasive wheel before welding. Do not use wheel for other jobs or tungsten can become contaminated causing lower weld quality.

2 Tungsten Electrode

A 2% ceriated tungsten is recommended.

3 Flat

Diameter of this flat determines amperage capacity.

4 Straight Ground

Grind lengthwise, **not radial**.

SECTION 12 – GUIDELINES FOR TIG WELDING (GTAW)

12-1. Positioning The Torch

⚠ Grinding the tungsten electrode produces dust and flying sparks which can cause injury and start fires. Use local exhaust (forced ventilation) at the grinder or wear an approved respirator. Read MSDS for safety information. Consider using cerium or lanthanum based tungsten instead of thoriated. Thorium dust contains low-level radioactive material. Properly dispose of grinder dust in an environmentally safe way. Wear proper face, hand, and body protection. Keep flammables away.

- 1 Workpiece
- 2 Work Clamp
- 3 Torch
- 4 Filler Rod (If Applicable)
- 5 Gas Cup
- 6 Tungsten Electrode

Make sure workpiece is clean before welding.

Place as close to the weld as possible.

Select and prepare tungsten according to Section 11.

Guidelines:

The inside diameter of the gas cup should be at least three times the tungsten diameter to provide adequate shielding gas coverage. (For example, if tungsten is 1/16 in. diameter, gas cup should be a minimum of 3/16 in. diameter.)

Tungsten extension is the distance the tungsten extends out gas cup of torch.

The tungsten extension should be no greater than the inside diameter of the gas cup.

Arc length is the distance from the tungsten to the workpiece.

Bottom View Of Gas Cup

Ref. ST-161 892

12-2. Torch Movement During Welding

Tungsten Without Filler Rod

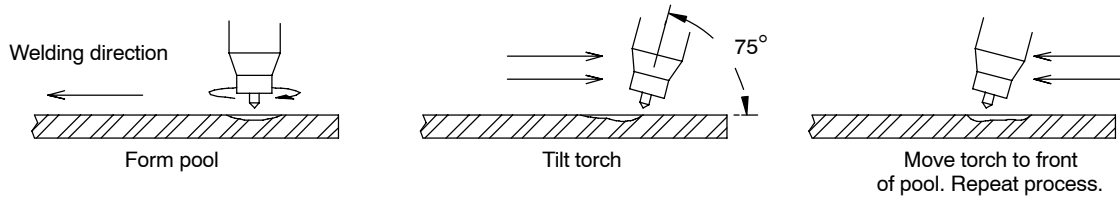

Tungsten With Filler Rod

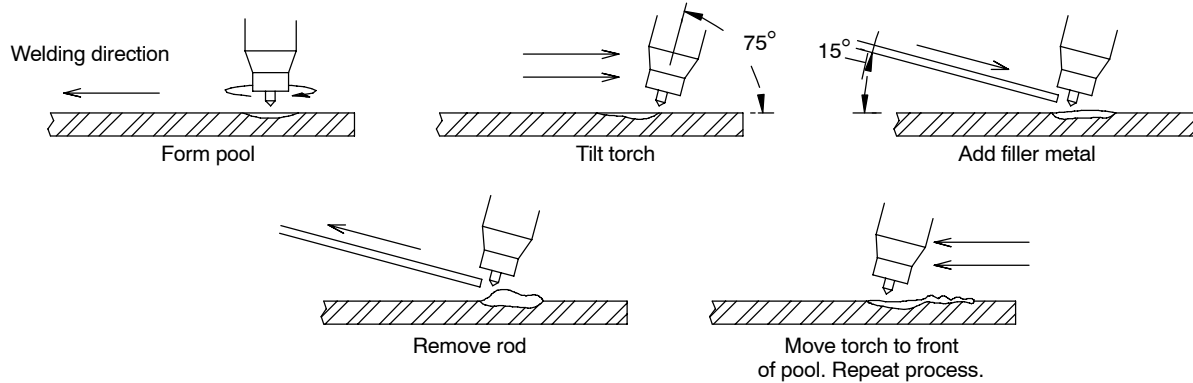

ST-162 002-B

12-3. Positioning Torch Tungsten For Various Weld Joints

Butt Weld And Stringer Bead

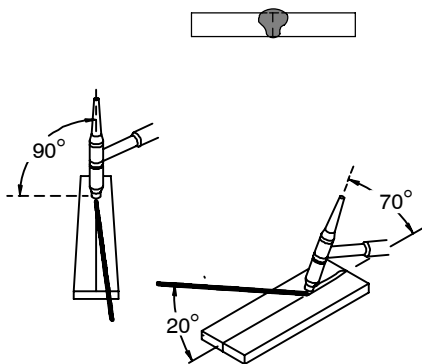

"T" Joint

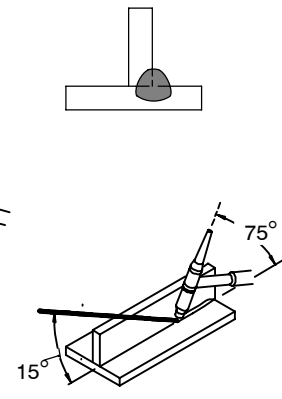

Lap Joint

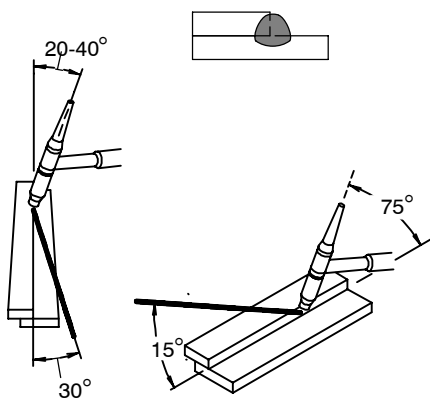

Corner Joint

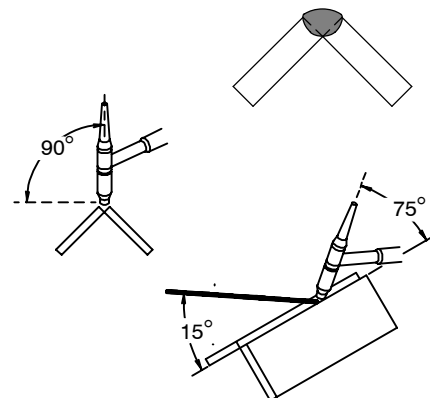

ST-162 003 / S-0792

SECTION 13 – SETUP GUIDE FOR (SMAW) STICK WELDING



13-1. Front Panel Display For Stick DCEP (Direct Current Electrode Positive)

1 Front Panel

Correct front panel display for basic Stick DCEP welding.

For all front panel switch pad controls: press switch pad to turn on light and enable function.

Gray on nameplate indicates a Stick function (see Section 5-1 for description of controls).

ST-207 690-A

SECTION 14 – STICK WELDING (SMAW) GUIDELINES

14-1. Stick Welding Procedure



Tools Needed:

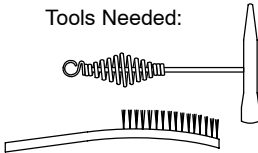

Equipment Needed:

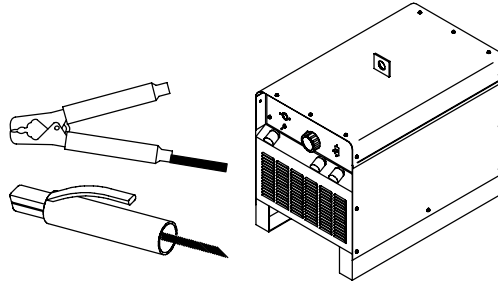

Constant Current
Welding Power Source

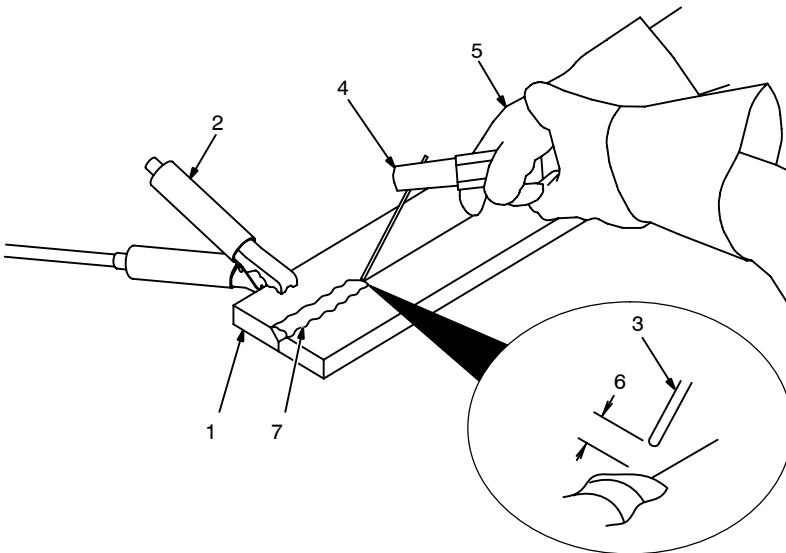

⚠ Weld current starts when electrode touches work-piece.

⚠ Weld current can damage electronic parts in vehicles. Disconnect both battery cables before welding on a vehicle. Place work clamp as close to the weld as possible.

ℹ Always wear appropriate personal protective clothing.

1 Workpiece

Make sure workpiece is clean before welding.

2 Work Clamp

3 Electrode

A small diameter electrode requires less current than a large one. Follow electrode manufacturer's instructions when setting weld amperage (see Section 14-2).

4 Insulated Electrode Holder

5 Electrode Holder Position

6 Arc Length

Arc length is the distance from the electrode to the workpiece. A short arc with correct amperage will give a sharp, crackling sound.

7 Slag

Use a chipping hammer and wire brush to remove slag. Remove slag and check weld bead before making another weld pass.

14-2. Electrode and Amperage Selection Chart



ELECTRODE	DIAMETER	AMPERAGE RANGE								
		50	100	150	200	250	300	350	400	450
6010 & 6011	3/32									
	1/8									
	5/32									
	3/16									
	7/32									
6013	1/4									
	1/16									
	5/64									
	3/32									
	1/8									
	5/32									
7014	3/16									
	7/32									
	1/4									
	3/32									
	1/8									
7018	5/32									
	3/16									
	7/32									
	1/4									
	3/32									
7024	1/8									
	5/32									
	3/16									
	7/32									
	1/4									
Ni-CI	3/32									
	1/8									
	5/32									
	3/16									
308L	3/32									
	1/8									
	5/32									

ELECTRODE	DC*	AC	POSITION	PENETRATION	USAGE
6010	EP		ALL	DEEP	MIN. PREP, ROUGH HIGH SPATTER
6011	EP	✓	ALL	DEEP	MIN. PREP, ROUGH HIGH SPATTER
6013	EP,EN	✓	ALL	LOW	GENERAL
7014	EP,EN	✓	ALL	MED	SMOOTH, EASY, FAST
7018	EP	✓	ALL	MED	LOW HYDROGEN, STRONG
7024	EP,EN	✓	FLAT HORIZ FILLET	LOW	SMOOTH, EASY, FASTER
NI-CL	EP	✓	ALL	LOW	CAST IRON
308L	EP	✓	ALL	LOW	STAINLESS

*EP = ELECTRODE POSITIVE (REVERSE POLARITY)
EN = ELECTRODE NEGATIVE (STRAIGHT POLARITY)

Ref. S-087 985-A

14-3. Striking an Arc

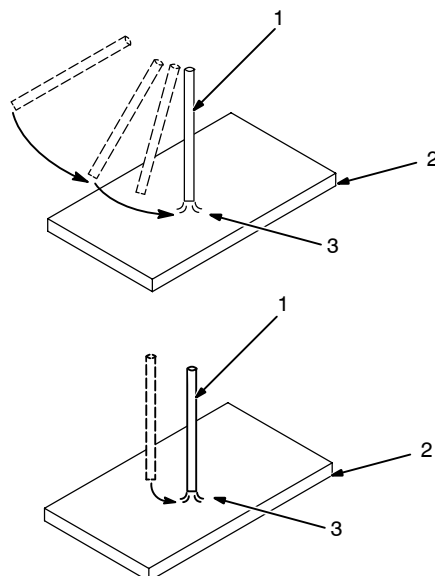

- 1 Electrode
- 2 Workpiece
- 3 Arc

Scratch Technique

Drag electrode across workpiece like striking a match; lift electrode slightly after touching work. If arc goes out, electrode was lifted too high. If electrode sticks to workpiece, use a quick twist to free it.

Tapping Technique

Bring electrode straight down to workpiece; then lift slightly to start arc. If arc goes out, electrode was lifted too high. If electrode sticks to workpiece, use a quick twist to free it.

S-0049 / S-0050

14-4. Positioning Electrode Holder



- 1 End View Of Work Angle
- 2 Side View Of Electrode Angle

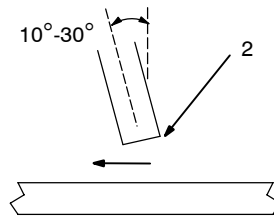
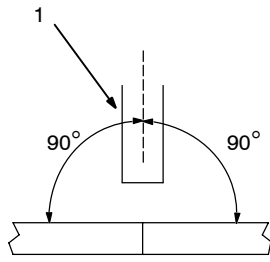

Groove Welds

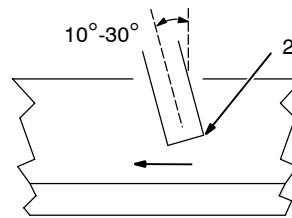
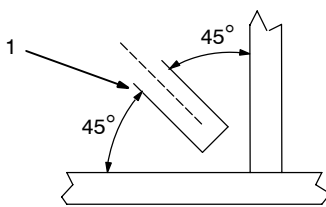

Fillet Welds

S-0060

14-5. Poor Weld Bead Characteristics

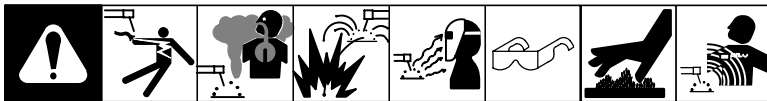

- 1 Large Spatter Deposits
- 2 Rough, Uneven Bead
- 3 Slight Crater During Welding
- 4 Bad Overlap
- 5 Poor Penetration

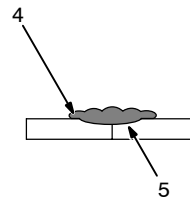
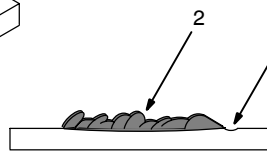
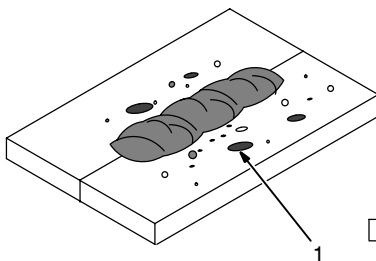

S-0053-A

14-6. Good Weld Bead Characteristics

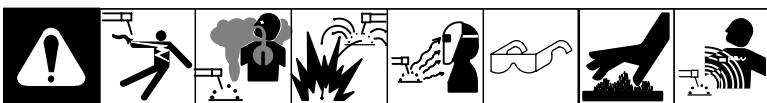

- 1 Fine Spatter
- 2 Uniform Bead
- 3 Moderate Crater During Welding

Weld a new bead or layer for each 1/8 in. (3.2 mm) thickness in metals being welded.

- 4 No Overlap
- 5 Good Penetration into Base Metal

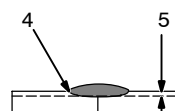
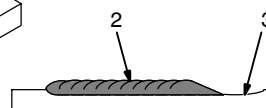
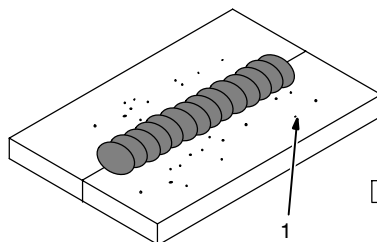

S-0052-B

14-7. Conditions That Affect Weld Bead Shape

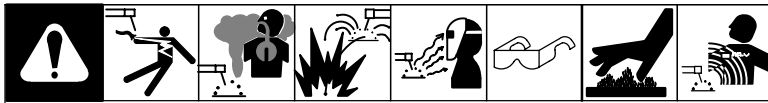

☞ Weld bead shape is affected by electrode angle, arc length, travel speed, and thickness of base metal.

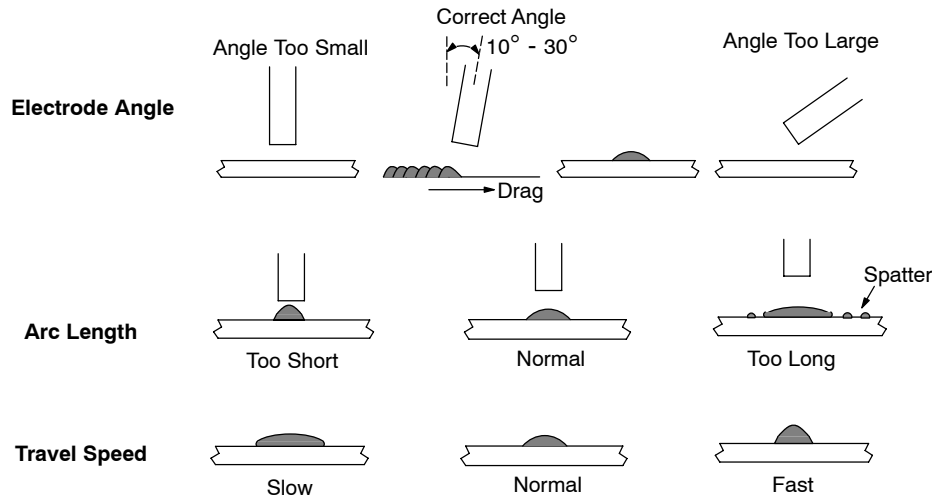

S-0061

14-8. Electrode Movement During Welding



☞ Normally, a single stringer bead is satisfactory for most narrow groove weld joints; however, for wide groove weld joints or bridging across gaps, a weave bead or multiple stringer beads work better.

- 1 Stringer Bead – Steady Movement Along Seam
- 2 Weave Bead – Side to Side Movement Along Seam
- 3 Weave Patterns

Use weave patterns to cover a wide area in one pass of the electrode. Do not let weave width exceed 2-1/2 times diameter of electrode.

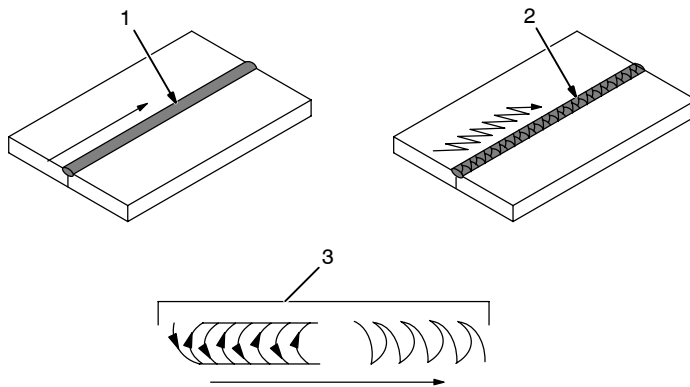

S-0054-A

14-9. Groove (Butt) Joints

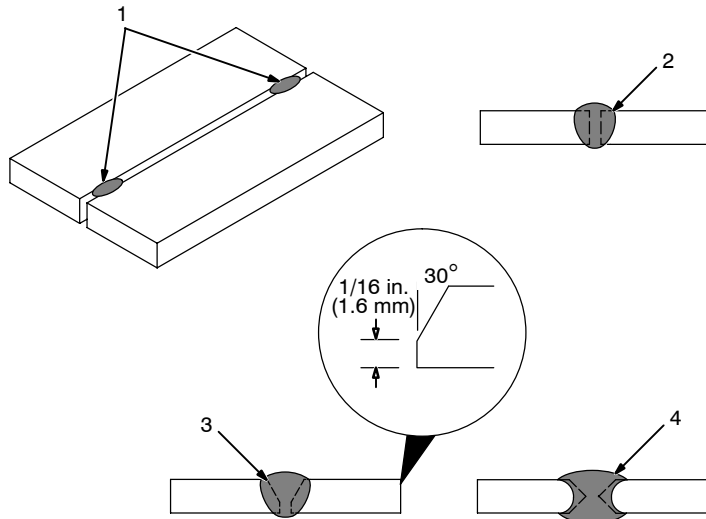

1 Tack Welds

Prevent edges of joint from drawing together ahead of electrode by tack welding the materials in position before final weld.

2 Square Groove Weld

Good for materials up to 3/16 in. (5 mm) thick.

3 Single V-Groove Weld

Good for materials 3/16 – 3/4 in. (5-19 mm) thick. Cut bevel with oxyacetylene or plasma cutting equipment. Remove scale from material after cutting. A grinder can also be used to prepare bevels.

Create 30 degree angle of bevel on materials in V-groove welding.

4 Double V-Groove Weld

Good for materials thicker than 3/16 in. (5 mm).

S-0062

14-10. Lap Joint

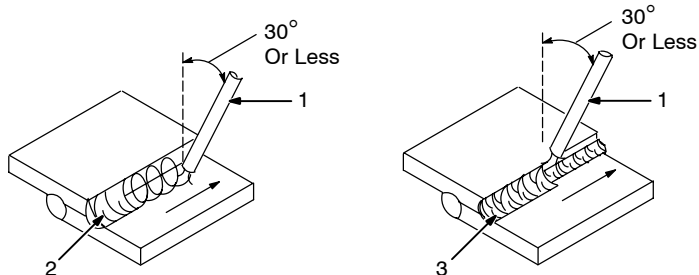

1 Electrode

2 Single-Layer Fillet Weld

Move electrode in circular motion.

3 Multi-Layer Fillet Weld

Weld a second layer when a heavier fillet is needed. Remove slag before making another weld pass. Weld both sides of joint for maximum strength.

S-0063 / S-0064

14-11. Tee Joint

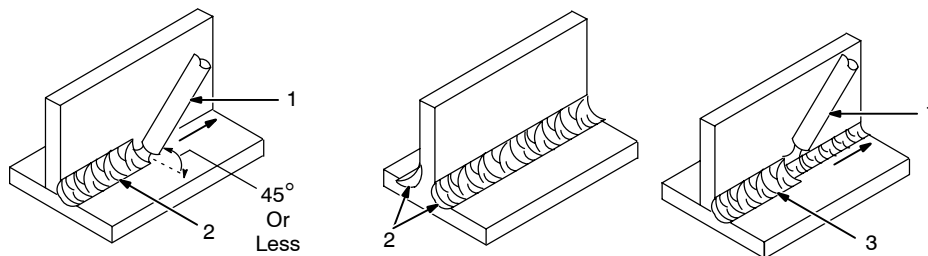

1 Electrode

2 Fillet Weld

Keep arc short and move at definite rate of speed. Hold electrode as shown to provide fusion into the corner. Square edge of the weld surface.

For maximum strength weld both sides of upright section.

3 Multi-Layer Deposits

Weld a second layer when a heavier fillet is needed. Use any of the weaving patterns shown in Section 14-8. Remove slag before making another weld pass.

S-0060 / S-0058-A / S-0061

14-12. Weld Test

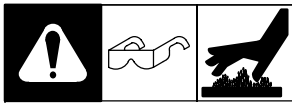

- 1 Vise
- 2 Weld Joint
- 3 Hammer

Strike weld joint in direction shown. A good weld bends over but does not break.

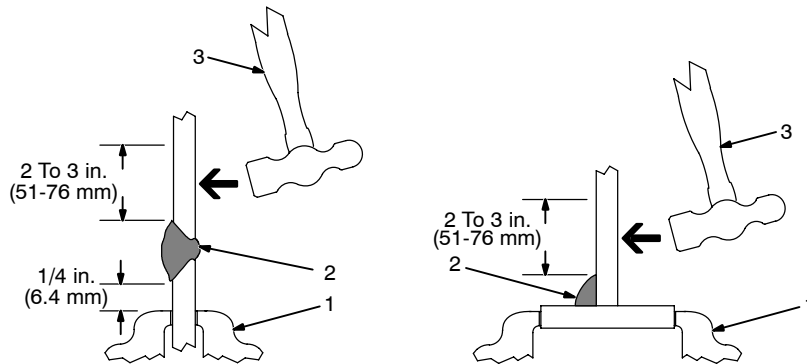

S-0057-B

14-13. Troubleshooting

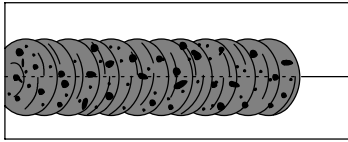
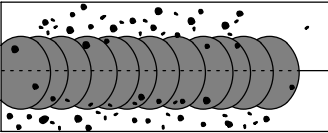
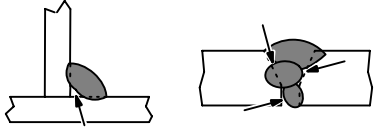
	<p>Porosity – small cavities or holes resulting from gas pockets in weld metal.</p>
<p>Possible Causes</p>	<p>Corrective Actions</p>
<p>Arc length too long.</p>	<p>Reduce arc length.</p>
<p>Damp electrode.</p>	<p>Use dry electrode.</p>
<p>Workpiece dirty.</p>	<p>Remove all grease, oil, moisture, rust, paint, coatings, slag, and dirt from work surface before welding.</p>
	<p>Excessive Spatter – scattering of molten metal particles that cool to solid form near weld bead.</p>
<p>Possible Causes</p>	<p>Corrective Actions</p>
<p>Amperage too high for electrode.</p>	<p>Decrease amperage or select larger electrode.</p>
<p>Arc length too long or voltage too high.</p>	<p>Reduce arc length or voltage.</p>
	<p>Incomplete Fusion – failure of weld metal to fuse completely with base metal or a preceding weld bead.</p>
<p>Possible Causes</p>	<p>Corrective Actions</p>
<p>Insufficient heat input.</p>	<p>Increase amperage. Select larger electrode and increase amperage.</p>
<p>Improper welding technique.</p>	<p>Place stringer bead in proper location(s) at joint during welding.</p>
	<p>Adjust work angle or widen groove to access bottom during welding.</p>
	<p>Momentarily hold arc on groove side walls when using weaving technique.</p>
	<p>Keep arc on leading edge of weld puddle.</p>
<p>Workpiece dirty.</p>	<p>Remove all grease, oil, moisture, rust, paint, coatings, slag, and dirt from work surface before welding.</p>

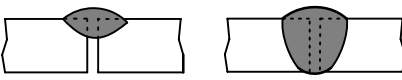
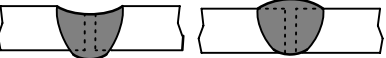
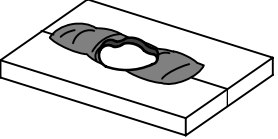
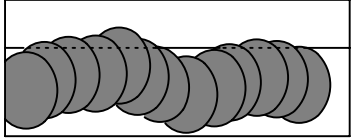
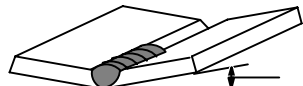
 <p>Lack of Penetration Good Penetration</p>	<p>Lack Of Penetration – shallow fusion between weld metal and base metal.</p>
<p>Possible Causes</p>	<p>Corrective Actions</p>
<p>Improper joint preparation.</p>	<p>Material too thick. Joint preparation and design must provide access to bottom of groove.</p>
<p>Improper weld technique.</p>	<p>Keep arc on leading edge of weld puddle.</p>
<p>Insufficient heat input.</p>	<p>Increase amperage. Select larger electrode and increase amperage.</p>
	<p>Reduce travel speed.</p>
 <p>Excessive Penetration Good Penetration</p>	<p>Excessive Penetration – weld metal melting through base metal and hanging underneath weld.</p>
<p>Possible Causes</p>	<p>Corrective Actions</p>
<p>Excessive heat input.</p>	<p>Select lower amperage. Use smaller electrode.</p>
	<p>Increase and/or maintain steady travel speed.</p>
	<p>Burn-Through – weld metal melting completely through base metal resulting in holes where no metal remains.</p>
<p>Possible Causes</p>	<p>Corrective Actions</p>
<p>Excessive heat input.</p>	<p>Select lower amperage. Use smaller electrode.</p>
	<p>Increase and/or maintain steady travel speed.</p>
	<p>Waviness Of Bead – weld metal that is not parallel and does not cover joint formed by base metal.</p>
<p>Possible Causes</p>	<p>Corrective Actions</p>
<p>Unsteady hand.</p>	<p>Use two hands. Practice technique.</p>
 <p>Base metal moves in the direction of the weld bead.</p>	<p>Distortion – contraction of weld metal during welding that forces base metal to move.</p>
<p>Possible Causes</p>	<p>Corrective Actions</p>
<p>Excessive heat input.</p>	<p>Use restraint (clamp) to hold base metal in position.</p>
	<p>Make tack welds along joint before starting welding operation.</p>
	<p>Select lower amperage for electrode.</p>
	<p>Increase travel speed.</p>
	<p>Weld in small segments and allow cooling between welds.</p>

Item No.	Dia. Mkgs.	Part No.	Description	Quantity
Figure 15-1. Main Assembly				
1		Fig15-2	Panel, Front W/Cmpnt	1
2		Fig15-3	Panel, Rear W/Cmpnt	1
3		Fig15-4	Magnetics Subassembly	1
4		Fig15-5	Windtunnel, W/Components	1
5		Fig15-7	Base Assy,	1
6	S1	231191	Switch, Tgl 3pst 50a 600vac Scr Term Wide Tgl	1
7		200393	Insulator, filter board (CE models)	1
8	PM1	204821	Kit, Input/Pre-Regulator Inverter	1
9		049611	Tubing, Cop .540 Od X .123 Wall X .687	1
10		196727	Cable, Power 10 Ft 12ga 4c Blk/Red/Wht/Grynel	1
11		+195643	Wrapper,	1
12		206108	Handle, Rubberized Carrying	1
13		195663	Strap, Shoulder 6 Ft	1
14		189782	Insulator, Interconnect Board	1
15	C7,C8	213974	Capacitor Assy,	1
16		189778	Plug W/Leads, Vfb	1
17		231376	Plug W/Leads, Arc Starter	1
18		189768	Plug W/Leads, Gas	1
19		189779	Cable, Lem W/Plugs	1
25		189784	Insulator, wrapper	2
28		203990	Label, Warning General Precautionary (Non CE Models)	2
28		179310	Label, Warning General Precautionary (CE Models)	2
30		185835	Label, Warning Electric Shock/Exploding Parts (Non CE Models)	1
30		185836	Label, Warning Electric Shock/Exploding Parts (CE Models)	1
33		215002	Clip, Support PC Mtg	2
35	C10	213912	Capacitor, Polye Film .1 UF 1000 VDC w/Terms (CE Models)	1
36	L4	241027	Core, Toroidal .748 ID X 1.142 OD X .600 Thk (CE Models)	1
37	L5	237542	Core, Toroidal .540 ID X .875 OD X .500 THhk (CE Models)	1
38		235497	Plug, w/Leads	1
400	PC2	207818	Circuit Card Assy, Power	1
400	PC2	230183	Circuit Card Assy, Power (CE Models)	1
401	PC1	237558	Circuit Card Assy, Inverter	1
401	PC1	237562	Circuit Card Assy, Inverter (CE Models)	1
402	PC10	235406	Circuit Card Assy, Boost	1
402	PC10	235410	Circuit Card Assy, Boost (CE Models)	1
403	PC 9	230203	Circuit Card Assy, Filter (CE Models)	1
600		229333	Screw, M10-1.5X 20 Hex Hd-pln 8.8 Pld Sems	2
614		136343	Screw, K50x 20 Pan Hd-phl Stl Pld Pt Thread Forming	2
615		229334	Screw, M 5-.8X 35 Pan Hd-phl Stl Pld Sems	4

+When ordering a component originally displaying a precautionary label, the label should also be ordered.

To maintain the factory original performance of your equipment, use only Manufacturer's Suggested Replacement Parts.

Model and serial number required when ordering parts from your local distributor.

☞ Hardware is common and not available unless listed.

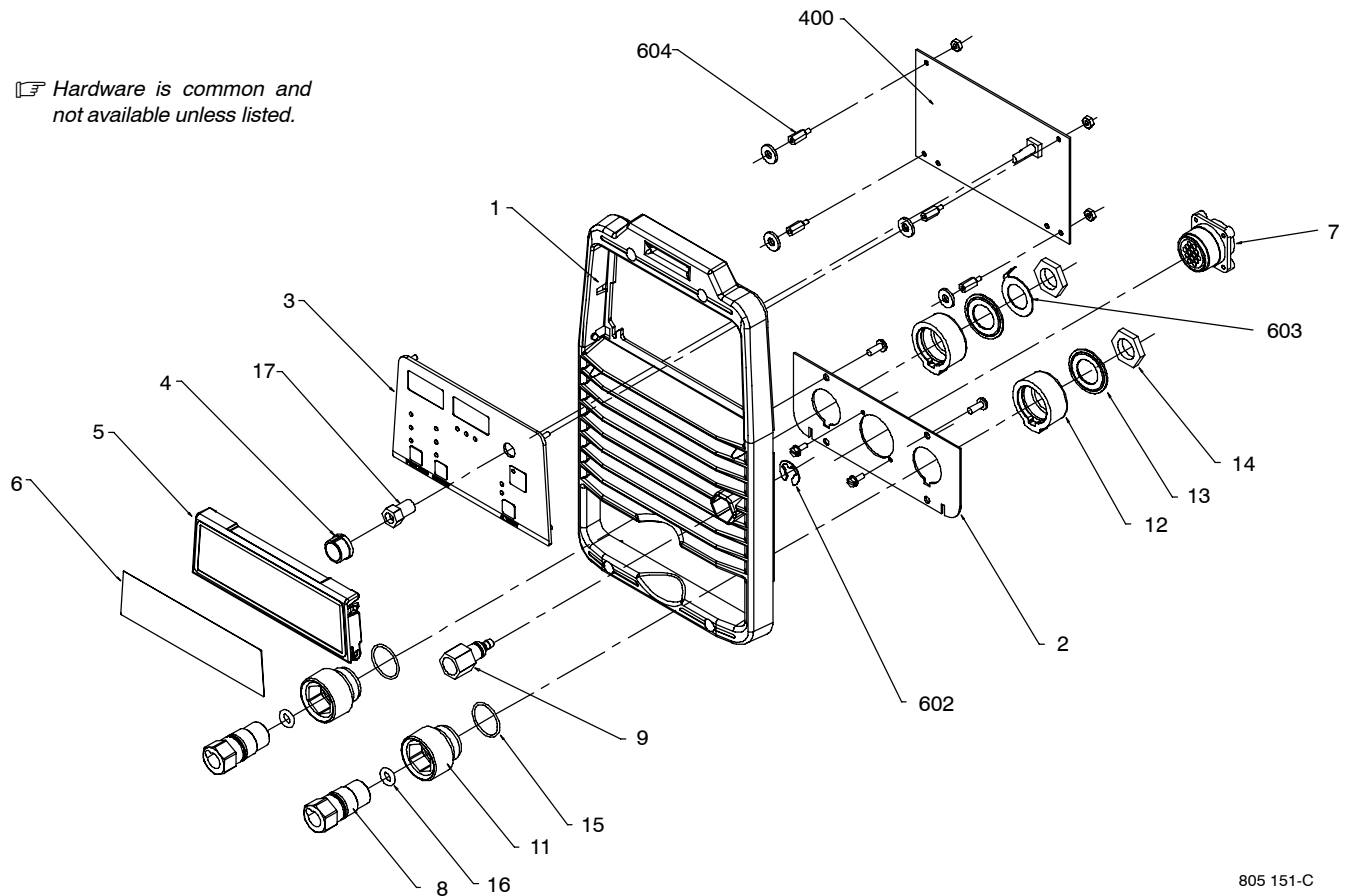

805 151-C

Figure 15-2. Panel, Front w/Components

Item No.	Dia. Mkgs.	Part No.	Description	Quantity
15-2. Panel, Front w/Components (Figure 15-1 Item 1)				
1		194242	Panel, Front/Rear	1
2		195647	Panel, Front Lower	1
3		244024	Membrane, Switch Control Maxstar 200 SD	1
3		244025	Membrane, Switch Control Maxstar 200 DX & LX	1
4		230052	Knob, .840 Dia X 6mm ID W/Spring Clip-4.5 mm Flat	1
5		194243	Door,	1
6		199008	Label, Door Maxstar 200 SD	1
6		199009	Label, Door Maxstar 200 DX	1
6		199010	Label, Door Maxstar 200 LX	1
7	RC1	189771	Receptacle W/Leads & Plug (14 Pin)	1
8		202553	Rcpt, Tw Lk Insul Fem(Dinse Type)50/70 Series Wsl	2
9		193649	Ftg, Gas Barbed 1/4 TBG 5/8-18 Female (Non CE Models)	1
9		193650	Ftg, Gas Barbed 1/4 TBG 3/8-19 BSPP Male (CE Models)	1
11		185712	Insulator, Bulkhead Front	2
12		185713	Insulator, Bulkhead Rear	2
13		229338	Washer, Domed Load .812 ID X 1.450 OD X .070 THK	2
14		185717	Nut, M20 X 1.5 1.0625 Hex .19 H Locking	2
15		185718	O-Ring 0.989 I.D. X 0.070 Wall	2
16		186228	O-Ring 0.739 I.D. X 0.070 Wall	2
17		235427	Bushing, Fig M7x.75x.68, 1/2 Inch Hex	1
400	PC3	242271	Circuit Card Assy, Control & Interface w/program	1
602		166560	Ring, Rtnng Ext .500 Shaft X .042 Thk E Style Bowed (Non CE Models)	1
603		178548	Terminal, Connector Friction	1
604		098691	Stand-off, No 6-32 X .500 Lg .250 Hex Stl M&F	4

To maintain the factory original performance of your equipment, use only Manufacturer's Suggested Replacement Parts. Model and serial number required when ordering parts from your local distributor.

☞ Hardware is common and not available unless listed.

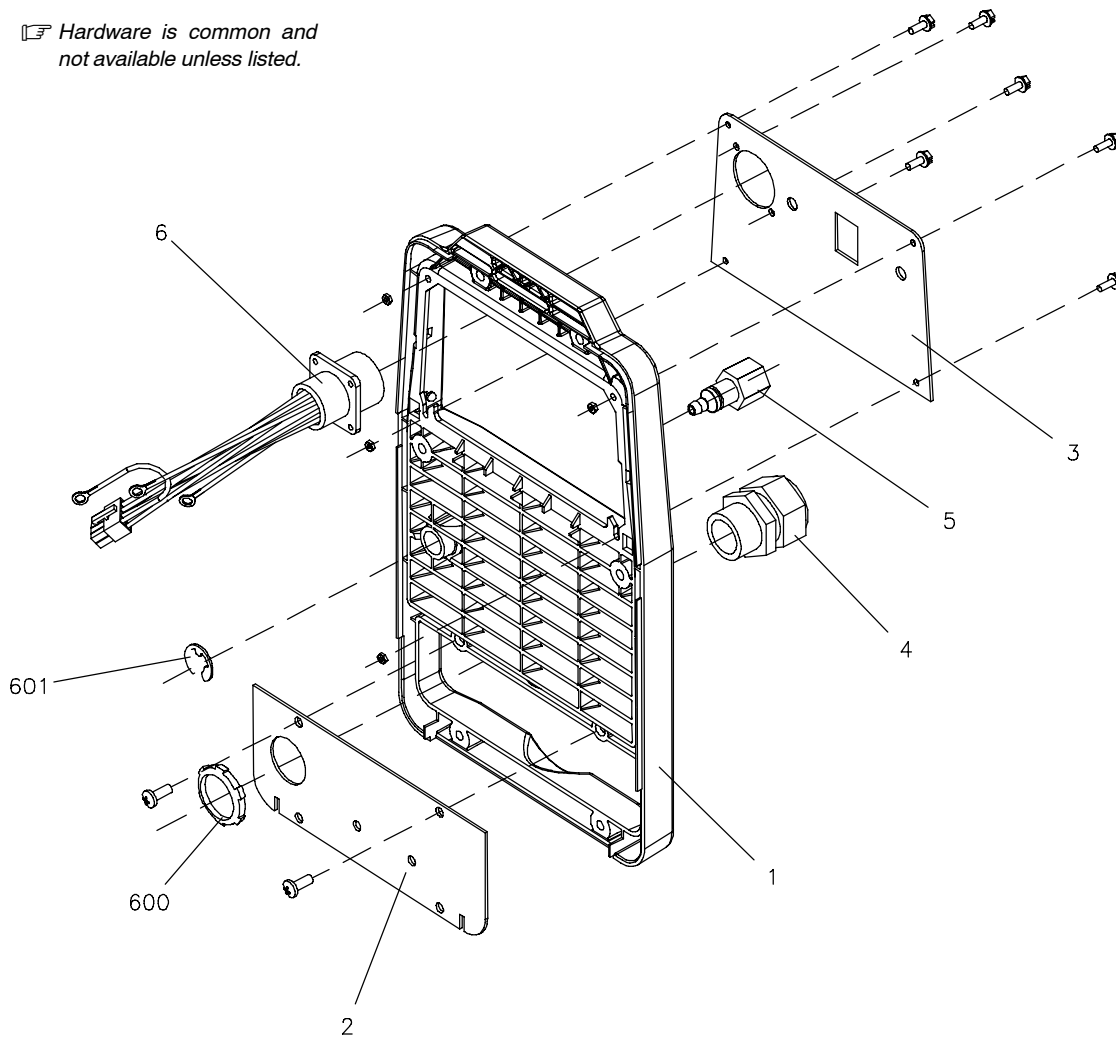

Figure 15-3. Panel, Rear w/Components

Ref. 199 492-C

Item No.	Dia. Mkgs.	Part No.	Description	Quantity
----------	------------	----------	-------------	----------

Figure 15-3. Panel, Rear w/Components (Figure 15-1 Item 2)

1		194242	Panel, Front/Rear	1
2		206053	Panel, Rear Lower	1
3		195646	Panel, Rear Upper (SD & DX Models)	1
3		197127	Panel, Rear Upper 10-pin (LX Models)	1
4		201155	Bushing, Strain Relief .450/ .709 ID X1.608 Mtg Hol	1
5		193649	Ftg, Gas Barbed 1/4 TBG 5/8-18 Female	1
5		193650	Ftg, Gas Barbed 1/4 TBG 3/8-19 BSPP Male (CE Models)	1
6	RC2	199882	Receptacle, W/Leads 4 Plug 10-pin (LX Models)	1
		146 212	Conn, Circ Ms/Met 10Pin Sz 18 Plug Cable Solder (Mates With RC2) (LX Models)	1
		200 544	Conn, Circ 97/Met Clamp Str Size 18 (Mates With RC2) (LX Models)	1
600		198245	Nut, Conduit .750 Npt Pld 1.388 Od X .150 Thk	1
601		166560	Ring, Rtnng Ext .500 Shaft X .042 Thk E Style Bowed	1

+When ordering a component originally displaying a precautionary label, the label should also be ordered.

To maintain the factory original performance of your equipment, use only Manufacturer's Suggested Replacement Parts. Model and serial number required when ordering parts from your local distributor.

Hardware is common and not available unless listed.

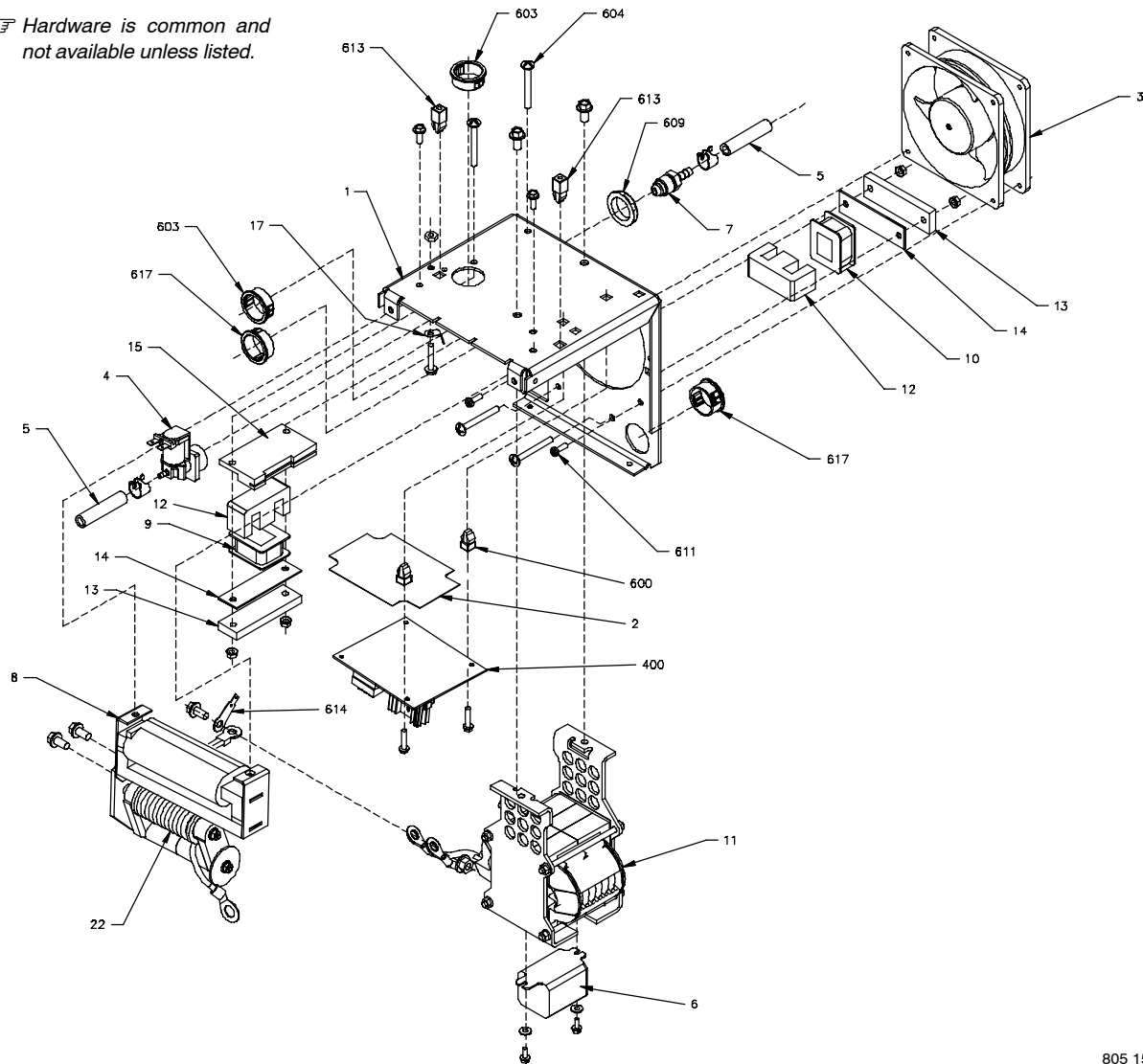

Figure 15-4. Magnetics Assembly w/Components

805 153-A

Item No.	Dia. Mkgs.	Part No.	Description	Quantity
----------	------------	----------	-------------	----------

**Figure 15-4. Magnetics Assembly w/Components
(Figure 15-1 Item 3)**

1		195649	Panel, Plenum	1
2		231378	Insulator	1
3	FM1	239380	Fan, Muffin 24vdc 3200 RPM 141 CFM 4.125 Mtg Holes	1
4	GS1	238805	Valve, 24VDC 2way 125 P.S.I.Custom Port .054 Orf W/Frict	1
5		210610	Hose, Nprn Brd No 1 X .250 Id X 12.250	2
6	CR1	198549	Relay, Encl 24vdc Spst 35a/300vac 4pin Flange Mtg	1
7		112863	Ftg, Hose Brs Barbed M 1/4 Tbg X 5/8-18 Sae Flare	1
8	Z1	189790	Inductor, Output	1
9	L2	210599	Coil, inductor 9T	1
10	L3	206020	Coil, inductor 14T	1
11	T1	212268	Xfmr, HF Litz/Litz w/Boost	1
12		109056	Core, Ferrite E 2.164 Lg X 1.094 High X .826 Wide	2
13		196512	Bracket, Inductor Mounting	2
14		196514	Gasket, Inductor Mounting	2
15		200385	Bracket, Mtg HF	1
17		231208	Connector, Faston 1/4 Ring W/75 deg Bend	1
22	T2	233190	Coil, XFMR Coupling	1
400	PC7	212890	Circuit Card Assy, Arc Starter	1
400	PC7	228593	Circuit Card Assy, Arc Starter (CE Models)	1

Item No.	Dia. Mkgs.	Part No.	Description	Quantity
Figure 15-4. Magnetics Assembly w/Components (Figure 15-1 Item 3) (Continued)				
600		199538	Grommet, Scr No 8/10 Panel Hole .281 Sq .250 High	4
603		057357	Bushing, Snap-in Nyl .937 Id X 1.125 Mtg Hole	2
609		137761	Nut, 750NPT 1.31Hex .27h Nyl Blk	1
611		231179	Screw, K50 x 20 Pan Hd-phl Stl Pld Pt Thread Forming	2
614		010381	Connector, Rectifier	1
617		170647	Bushing, Snap-in Nyl 1.312 ID X 1.500 Mtg Hole	2

To maintain the factory original performance of your equipment, use only Manufacturer's Suggested Replacement Parts. Model and serial number required when ordering parts from your local distributor.

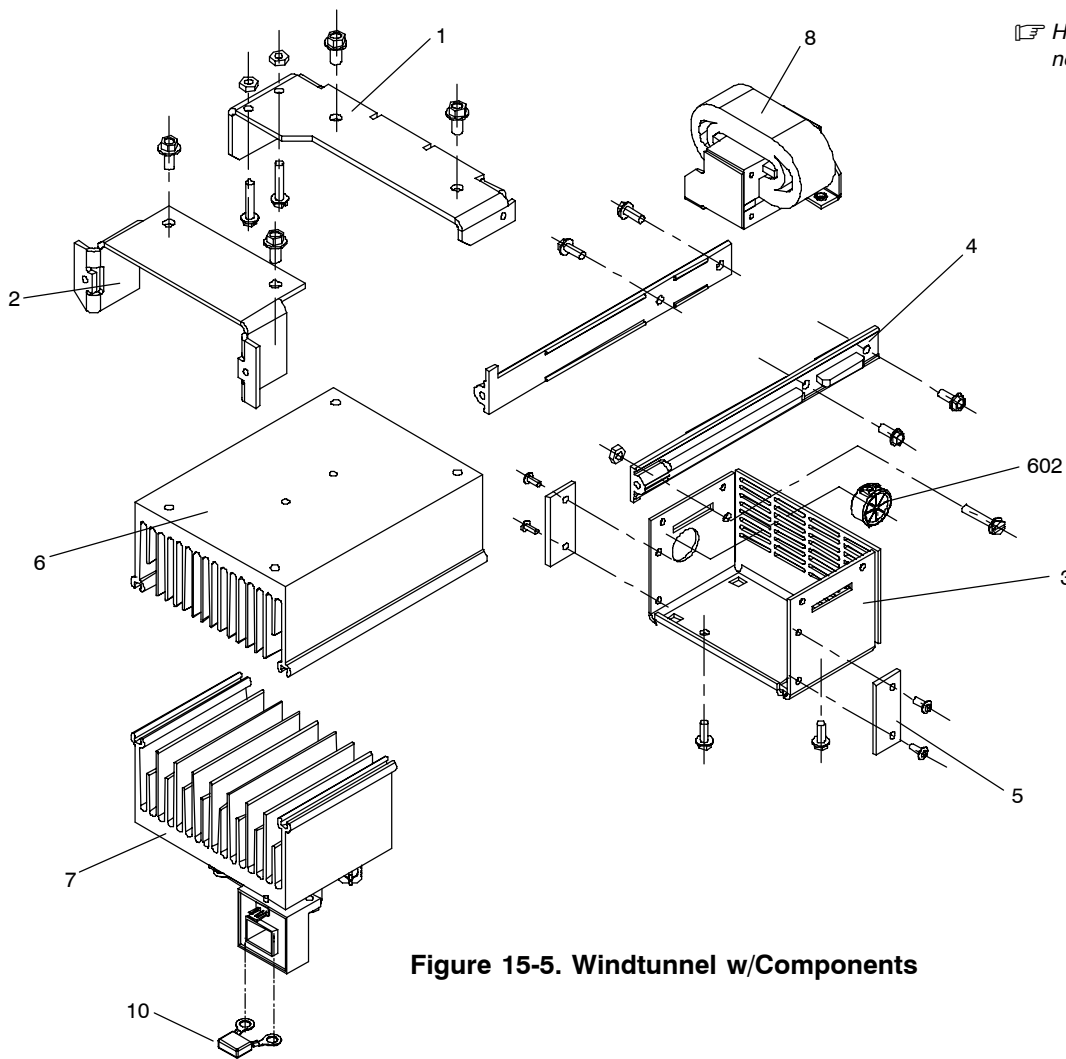

Hardware is common and not available unless listed.

Figure 15-5. Windtunnel w/Components

Ref. 199 494-F

Item No.	Dia. Mkgs.	Part No.	Description	Quantity
Figure 15-5. Windtunnel w/Components (Figure 15-1 Item 4)				
1		195645	Bracket, Heatsink Rear	1
2		198634	Bracket, Front Heatsink Mtg	1
3		198633	Wind Tunnel	1
4		232856	Rail, Heat Sink	2
5		198652	Bracket, Windtunnel Insulator	2
6		+209949	Heat Sink, Primary	1
7		199497	Heat Sink, Secondary Assembly	1
8	L1	189787	Choke, Input	1
		083147	Grommet, Scr No 8/10 Panel Hole .312 Sq .500 High (CE Models)	4
10	C9	151328	Capacitor, Polyp Met Film .0047Uf 1000 Vdc W/T (CE Models)	1
602		154408	Bushing, Snap-in Nyl .562 Id X .875 Mtg Hole Cent	1

+When ordering a component originally displaying a precautionary label, the label should also be ordered.
To maintain the factory original performance of your equipment, use only Manufacturer's Suggested Replacement Parts. Model and serial number required when ordering parts from your local distributor.

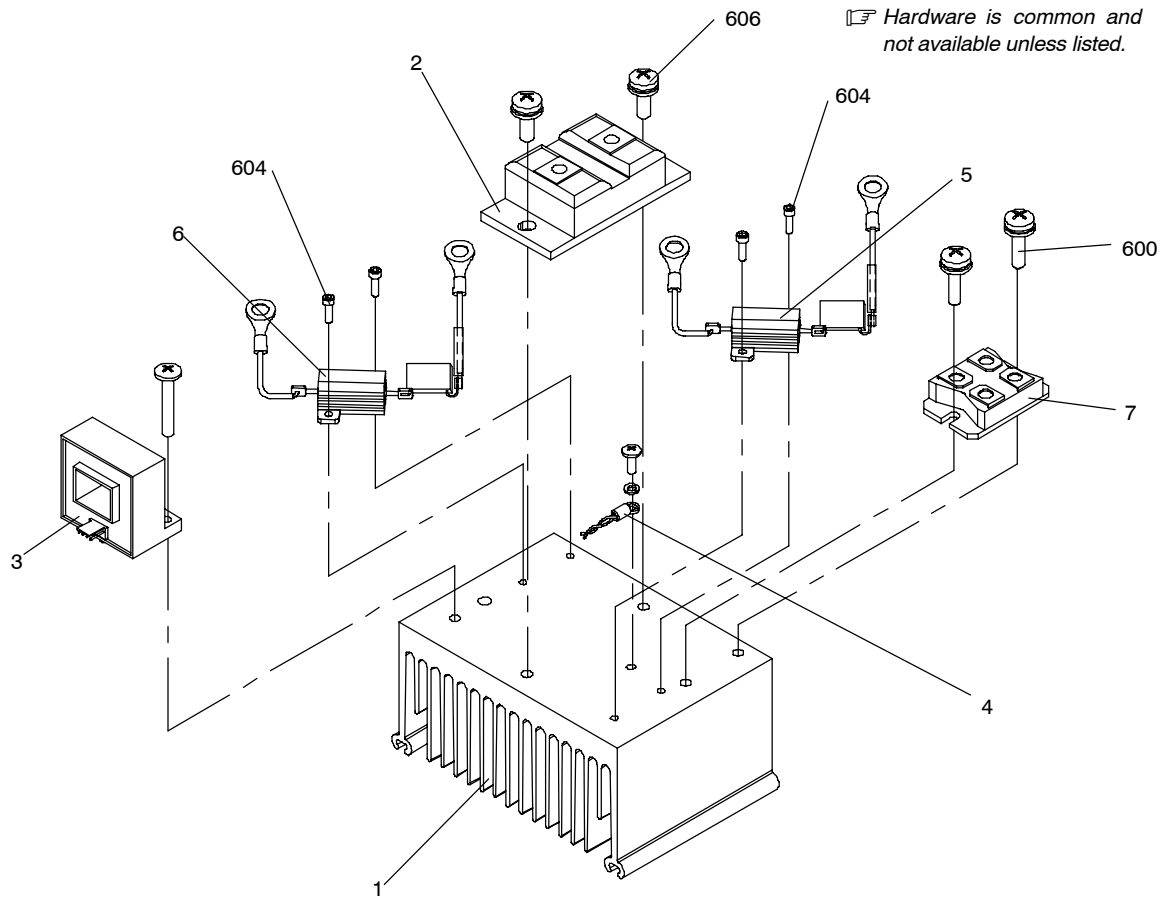

Figure 15-6. Heat Sink, Secondary Assembly

199 497-H

Item No.	Dia. Mkgs.	Part No.	Description	Quantity
----------	------------	----------	-------------	----------

**Figure 15-6. Heat Sink, Secondary Assembly
(Figure 15-5 Item 7)**

1		210783	Heat Sink, Secondary	1
2	D1	204820	Kit, Diode, Ultra Fast	1
3	HD1	198028	Transducer, Current 100a Module Supply V+/- 15v	1
4	RT1	211124	Thermistor, Ntc 30k Ohm @ 25 Deg C 18 in Lead	1
5	R2, C6	206021	Resistor/Capacitor,	1
6	R1, C5	199138	Resistor/Capacitor,	1
7	SR1	199952	Diode, Power Module 50 Amp 600V	1
600		207451	Screw, 008-32x .50 Pan Hd-Phl Stl Pld	2
606		229331	Screw, M 6-1.0x 16 Pan Hd-phl Stl Pld Sems	2

To maintain the factory original performance of your equipment, use only Manufacturer's Suggested Replacement Parts. Model and serial number required when ordering parts from your local distributor.

☞ Hardware is common and not available unless listed.

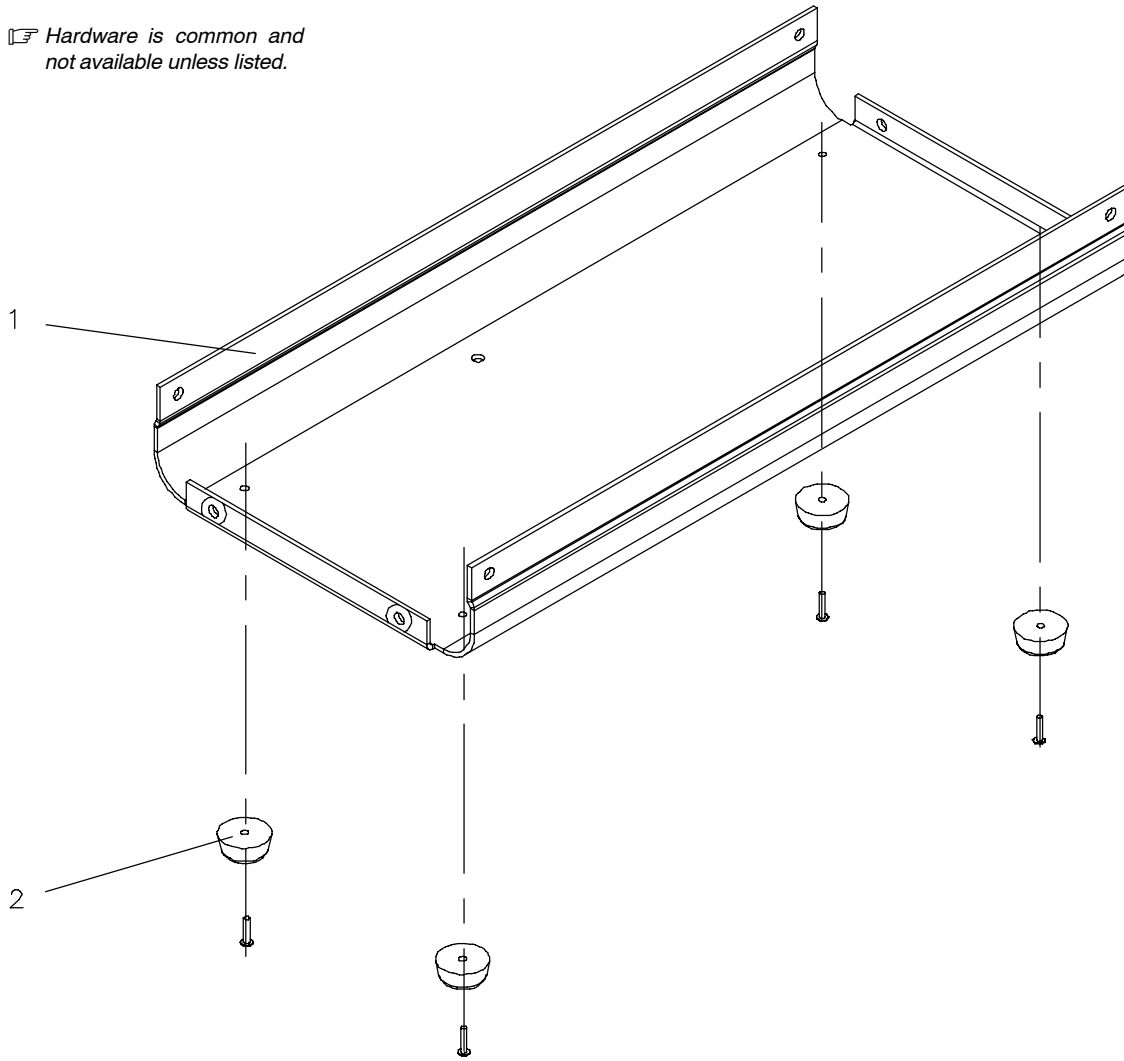



Figure 15-7. Base Assembly

199 493-B

Item No.	Dia. Mkgs.	Part No.	Description	Quantity
Figure 15-7. Base Assembly (Figure 15-1 Item 5)				
1		195644	Base,	1
2		239388	Bumper, RBR .875 OD x .188 ID x .39 High Recessed	4

To maintain the factory original performance of your equipment, use only Manufacturer's Suggested Replacement Parts. Model and serial number required when ordering parts from your local distributor.

SECTION 16 – COOLER PARTS LIST

 Hardware is common and not available unless listed.

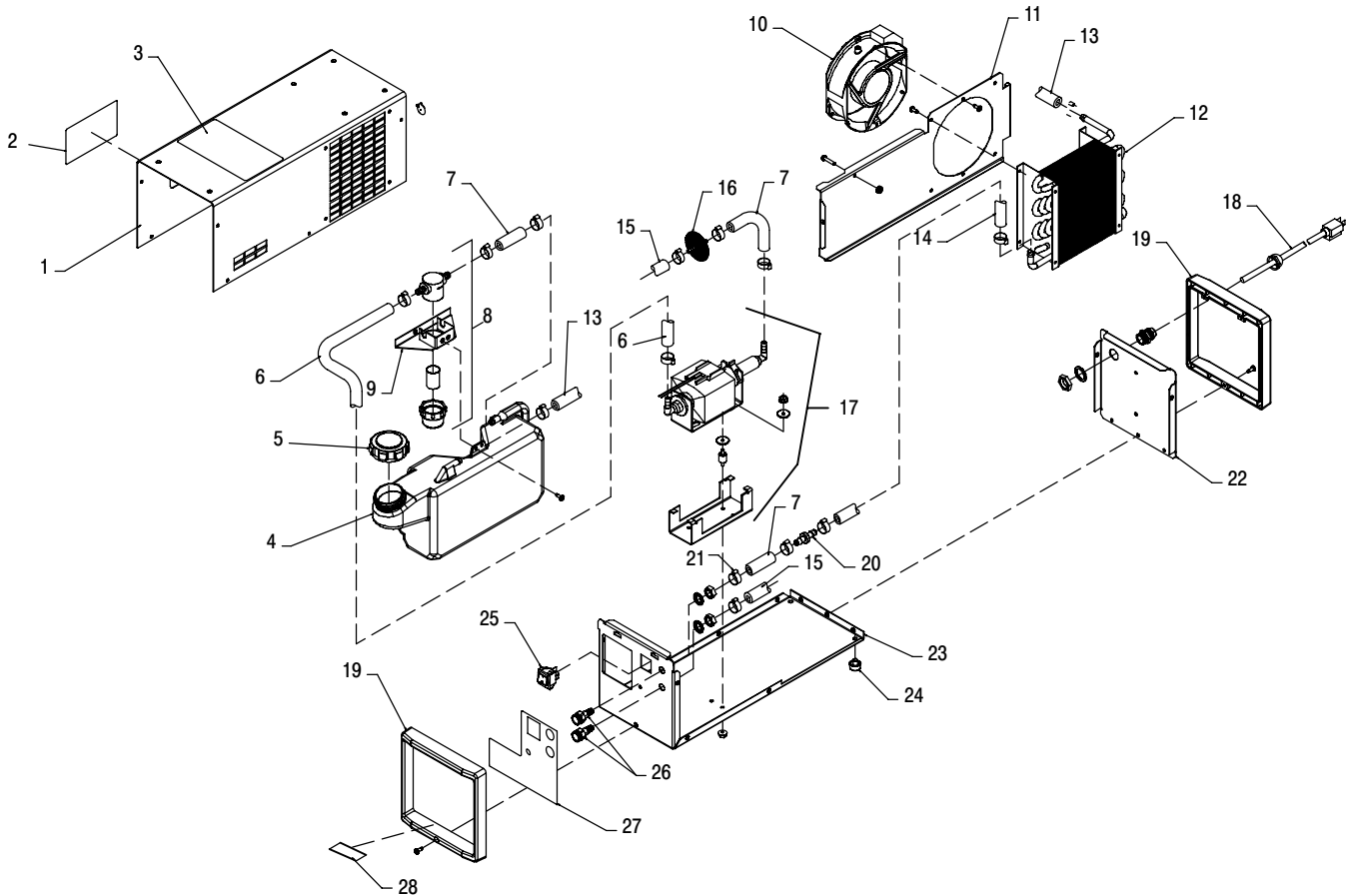

805 266-A

Figure 16-1. Main Assembly

Item No.	Dia. Mkgs.	Part No.	Description	Quantity
----------	------------	----------	-------------	----------

Figure 16-1. Main Assembly

1		+235416	.. Wrapper, ..	
2		188980	.. Label, Caution Incorrect Coolant ..	1
3		203990	.. Label, Warning General Precautionary Static ..	1
4		235422	.. Tank, Coolant ..	1
5		166608	.. Cap, Tank Screw-on W/Vent ..	1
6		237537	.. Hose, Rbr Brd No 1 X .375 ID X 11.250 Black ..	1
7		237535	.. Hose, Rbr Brd No 1 X .375 ID X 2.250 Black ..	3
8		166564	.. Filter, In-line Low Profile 100 Screen 3/8 Hose Bar ..	1
9		235419	.. Bracket, Filter ..	1
10	FM	213072	.. Fan, Muffin 115V 60 Hz 3400 RPM 6.378 Mtg Holes ..	1
10	FM	235504	.. Fan, Muffin 230V 60 Hz 3400 RPM 6.378 Mtg Holes ..	1
11		235418	.. Divider ..	1
12		237543	.. Radiator, Heat Exchanger ..	1
13		237538	.. Hose, Rbr Brd No 1 X .375 ID X 18.000 Black ..	1
14		237539	.. Hose, Rbr Brd No 1 X .375 ID X 11.50 Black ..	1
15		237536	.. Hose, Rbr Brd No 1 X .375 ID X 9.00 Black ..	2
16		235461	.. Damper, Fluid Pulsation ..	1
17	MOT	235457	.. Pump, Assy Coolant (115V) ..	1
17	MOT	235501	.. Pump, Assy Coolant (230V) ..	1
18	PLG1	192457	.. Cable, Power 11 Ft 7 In 16ga 3c (115V) ..	1
18	PLG1	192458	.. Cable, Power 11 Ft 7 In 16ga 3c (230V) ..	1
19		235423	.. Bezel, ..	2
20		240279	.. Valve, Check 3/8 Barb Inline ..	1
21		094263	.. Clamp, 1-ear Type Nom Dim .718 X .276 Wide ..	14
22		235417	.. Panel, Rear ..	1
23		235415	.. Base, ..	1
24		019663	.. Mount, NPRN 15/16 OD x 3/8 Rec 3/16 x 3/8 ..	4
25	S1	237540	.. Switch, Rocker Dpst 16 A 115 VAC On-Off ..	1
25	S1	237541	.. Switch, Rocker Dpst 16 A 230 VAC On-Off ..	1
26		235499	.. Ftg, Coolant Barbed 3/8 Tbg 5/8-18 Female ..	2
27			.. Nameplate, Miller Coolmate 1 (Order By Model And Serial Number) ..	1
28		287120	.. Label, Notice Pump Priming Noise Can Occur During ..	1

To maintain the factory original performance of your equipment, use only Manufacturer's Suggested Replacement Parts. Model and serial number required when ordering parts from your local distributor.

+When ordering a component originally displaying a precautionary label, the label should also be ordered.

SECTION 17 – CART PARTS LIST

 Hardware is common and not available unless listed.

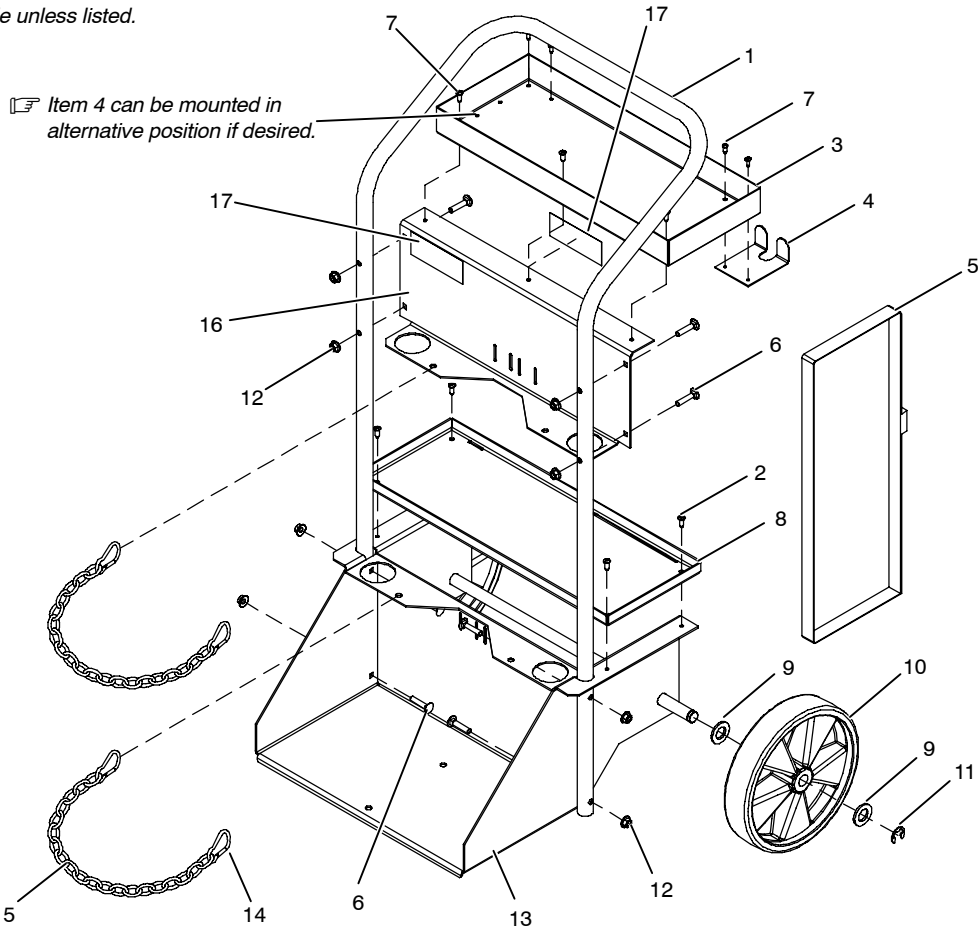

805 337-B

Figure 17-1. Cart Main Assembly

Item No.	Dia. Mkgs.	Part No.	Description	Quantity
----------	------------	----------	-------------	----------

Figure 17-1. Cart Main Assembly

1		235507	Handle, Cart	1
2		227147	Screw, 250–20x .62 Pan Hd–torx Stl Pld Blk Tap–r	4
3		+237593	Tray	1
4		237594	Cable Holder	2
5		235521	Strap, Tie Down 1.000 w X 60.000 lg (300lbs)	2
6		235527	Bolt, Crg Stl .312–18 X 1.500 Gr2 Pld Zinc Clear	8
7		195666	Screw, 010–32 x .50 Pan Hd–torx W/Gndrng Stl Pld	7
8		235515	Tray, Cooler	1
9		602250	Washer, Flat .812 ID x 1.469 OD x .134t Stl Pld Ansi.750	4
10		163463	Wheel, Rbr Tire 10.000 OD X 2.000 Wide X .750 Bore	2
11		121614	Ring, Rtnng Ext .750 Shaft X .085 Thk E Style Pld	2
12		231184	Nut, 312–18 .50 Hex .27h Stl Pld Sem Cone Wshr.76d	8
13		235517	Bottle Tray Assy, Cart	1
14		168663	Hook, spring .250, 2.375 Lg, .312 Snap Opening	4
15		210224	Chain	2
16		+235518	Support, Bottle/Tray	1
17		200285	Label, Warning Cylinder May Explode If Damaged	2

To maintain the factory original performance of your equipment, use only Manufacturer's Suggested Replacement Parts. Model and serial number required when ordering parts from your local distributor.

+When ordering a component originally displaying a precautionary label, the label should also be ordered.

TRUE BLUE[®]

WARRANTY

Effective January 1, 2010

(Equipment with a serial number preface of MA or newer)

This limited warranty supersedes all previous Miller warranties and is exclusive with no other guarantees or warranties expressed or implied.

Warranty Questions?

Call
1-800-4-A-MILLER
for your local
Miller distributor.

Your distributor also gives
you ...

Service

You always get the fast,
reliable response you
need. Most replacement
parts can be in your
hands in 24 hours.

Support

Need fast answers to the
tough welding questions?
Contact your distributor.
The expertise of the
distributor and Miller is
there to help you, every
step of the way.

LIMITED WARRANTY – Subject to the terms and conditions below, Miller Electric Mfg. Co., Appleton, Wisconsin, warrants to its original retail purchaser that new Miller equipment sold after the effective date of this limited warranty is free of defects in material and workmanship at the time it is shipped by Miller. THIS WARRANTY IS EXPRESSLY IN LIEU OF ALL OTHER WARRANTIES, EXPRESS OR IMPLIED, INCLUDING THE WARRANTIES OF MERCHANTABILITY AND FITNESS.

Within the warranty periods listed below, Miller will repair or replace any warranted parts or components that fail due to such defects in material or workmanship. Miller must be notified in writing within thirty (30) days of such defect or failure, at which time Miller will provide instructions on the warranty claim procedures to be followed.

Miller shall honor warranty claims on warranted equipment listed below in the event of such a failure within the warranty time periods. All warranty time periods start on the delivery date of the equipment to the original end-user purchaser, and not to exceed one year after the equipment is shipped to a North American distributor or eighteen months after the equipment is shipped to an International distributor.

- 5 Years Parts — 3 Years Labor
 - * Original main power rectifiers only to include SCRs, diodes, and discrete rectifier modules
- 3 Years — Parts and Labor
 - * Engine Driven Welding Generators
(NOTE: Engines are warranted separately by the engine manufacturer.)
 - * Inverter Power Sources (Unless Otherwise Stated)
 - * Plasma Arc Cutting Power Sources
 - * Process Controllers
 - * Semi-Automatic and Automatic Wire Feeders
 - * Smith 30 Series Flowgauge and Flowmeter Regulators (No Labor)
 - * Transformer/Rectifier Power Sources
 - * Water Coolant Systems (Integrated)
- 2 Years — Parts
 - * Auto-Darkening Helmet Lenses (No Labor)
- 1 Year — Parts and Labor Unless Specified
 - * Automatic Motion Devices
 - * CoolBelt and CoolBand Blower Unit (No Labor)
 - * External Monitoring Equipment and Sensors
 - * Field Options
(NOTE: Field options are covered for the remaining warranty period of the product they are installed in, or for a minimum of one year — whichever is greater.)
 - * Flowgauge and Flowmeter Regulators (No Labor)
 - * RFCS Foot Controls (Except RFCS-RJ45)
 - * Fume Extractors
 - * HF Units
 - * ICE Plasma Cutting Torches (No Labor)
 - * Induction Heating Power Sources, Coolers, and Electronic Controls/Recorders
 - * Load Banks
 - * Motor Driven Guns (w/exception of Spoolmate Spoolguns)
 - * PAPR Blower Unit (No Labor)
 - * Positioners and Controllers
 - * Racks
 - * Running Gear/Trailers
 - * Spot Welders
 - * Subarc Wire Drive Assemblies
 - * Water Coolant Systems (Non-Integrated)
 - * Weldcraft-Branded TIG Torches (No Labor)
 - * Work Stations/Weld Tables (No Labor)
- 6 Months — Parts
 - * Batteries
 - * Bernard Guns (No Labor)
 - * Tregaskiss Guns (No Labor)

- 90 Days — Parts
 - * Accessory (Kits)
 - * Canvas Covers
 - * Induction Heating Coils and Blankets, Cables, and Non-Electronic Controls
 - * M-Guns
 - * MIG Guns and Subarc (SAW) Guns
 - * Remote Controls and RFCS-RJ45
 - * Replacement Parts (No labor)
 - * Roughneck Guns
 - * Spoolmate Spoolguns

Miller's True Blue[®] Limited Warranty shall not apply to:

- Consumable components; such as contact tips, cutting nozzles, contactors, brushes, relays, work station table tops and welding curtains, or parts that fail due to normal wear. (Exception: brushes and relays are covered on all engine-driven products.)**
- Items furnished by Miller, but manufactured by others, such as engines or trade accessories. These items are covered by the manufacturer's warranty, if any.
- Equipment that has been modified by any party other than Miller, or equipment that has been improperly installed, improperly operated or misused based upon industry standards, or equipment which has not had reasonable and necessary maintenance, or equipment which has been used for operation outside of the specifications for the equipment.

MILLER PRODUCTS ARE INTENDED FOR PURCHASE AND USE BY COMMERCIAL/INDUSTRIAL USERS AND PERSONS TRAINED AND EXPERIENCED IN THE USE AND MAINTENANCE OF WELDING EQUIPMENT.

In the event of a warranty claim covered by this warranty, the exclusive remedies shall be, at Miller's option: (1) repair; or (2) replacement; or, where authorized in writing by Miller in appropriate cases, (3) the reasonable cost of repair or replacement at an authorized Miller service station; or (4) payment of or credit for the purchase price (less reasonable depreciation based upon actual use) upon return of the goods at customer's risk and expense. Miller's option of repair or replacement will be F.O.B., Factory at Appleton, Wisconsin, or F.O.B. at a Miller authorized service facility as determined by Miller. Therefore no compensation or reimbursement for transportation costs of any kind will be allowed.

TO THE EXTENT PERMITTED BY LAW, THE REMEDIES PROVIDED HEREIN ARE THE SOLE AND EXCLUSIVE REMEDIES. IN NO EVENT SHALL MILLER BE LIABLE FOR DIRECT, INDIRECT, SPECIAL, INCIDENTAL OR CONSEQUENTIAL DAMAGES (INCLUDING LOSS OF PROFIT), WHETHER BASED ON CONTRACT, TORT OR ANY OTHER LEGAL THEORY.

ANY EXPRESS WARRANTY NOT PROVIDED HEREIN AND ANY IMPLIED WARRANTY, GUARANTY OR REPRESENTATION AS TO PERFORMANCE, AND ANY REMEDY FOR BREACH OF CONTRACT TORT OR ANY OTHER LEGAL THEORY WHICH, BUT FOR THIS PROVISION, MIGHT ARISE BY IMPLICATION, OPERATION OF LAW, CUSTOM OF TRADE OR COURSE OF DEALING, INCLUDING ANY IMPLIED WARRANTY OF MERCHANTABILITY OR FITNESS FOR PARTICULAR PURPOSE, WITH RESPECT TO ANY AND ALL EQUIPMENT FURNISHED BY MILLER IS EXCLUDED AND DISCLAIMED BY MILLER.

Some states in the U.S.A. do not allow limitations of how long an implied warranty lasts, or the exclusion of incidental, indirect, special or consequential damages, so the above limitation or exclusion may not apply to you. This warranty provides specific legal rights, and other rights may be available, but may vary from state to state.

In Canada, legislation in some provinces provides for certain additional warranties or remedies other than as stated herein, and to the extent that they may not be waived, the limitations and exclusions set out above may not apply. This Limited Warranty provides specific legal rights, and other rights may be available, but may vary from province to province.





Owner's Record

Please complete and retain with your personal records.

Model Name

Serial/Style Number

Purchase Date

(Date which equipment was delivered to original customer.)

Distributor

Address

City

State

Zip



For Service

Contact a DISTRIBUTOR or SERVICE AGENCY near you.

Always provide Model Name and Serial/Style Number.

Contact your Distributor for:

Welding Supplies and Consumables

Options and Accessories

Personal Safety Equipment

Service and Repair

Replacement Parts

Training (Schools, Videos, Books)

Technical Manuals (Servicing Information and Parts)

Circuit Diagrams

Welding Process Handbooks

To locate a Distributor or Service Agency visit www.millerwelds.com or call 1-800-4-A-Miller

Contact the Delivering Carrier to:

File a claim for loss or damage during shipment.

For assistance in filing or settling claims, contact your distributor and/or equipment manufacturer's Transportation Department.

Miller Electric Mfg. Co.

An Illinois Tool Works Company
1635 West Spencer Street
Appleton, WI 54914 USA

International Headquarters-USA

USA Phone: 920-735-4505 Auto-Attended
USA & Canada FAX: 920-735-4134
International FAX: 920-735-4125

For International Locations Visit
www.MillerWelds.com

